

4370

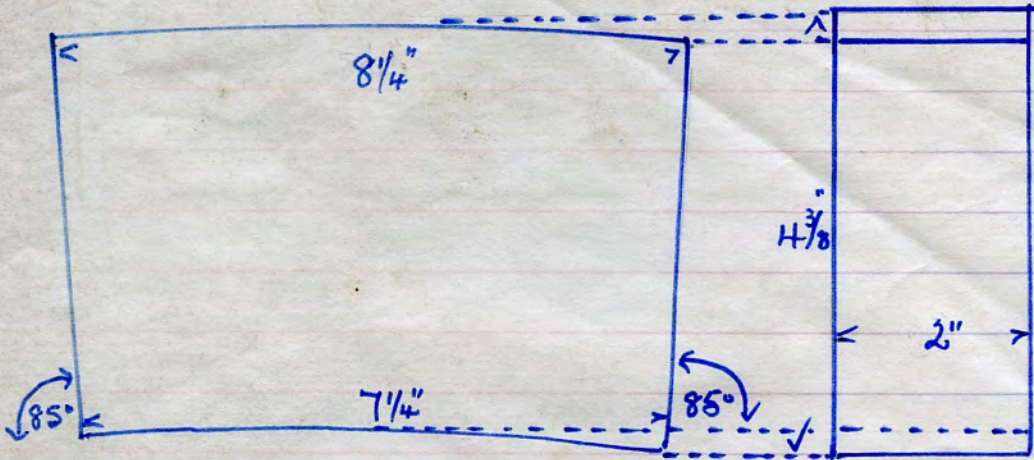

No name 38 L 43 red T.C. 5 3/4 lbs.

No name 58 ND red T.C 4 lbs.

4371

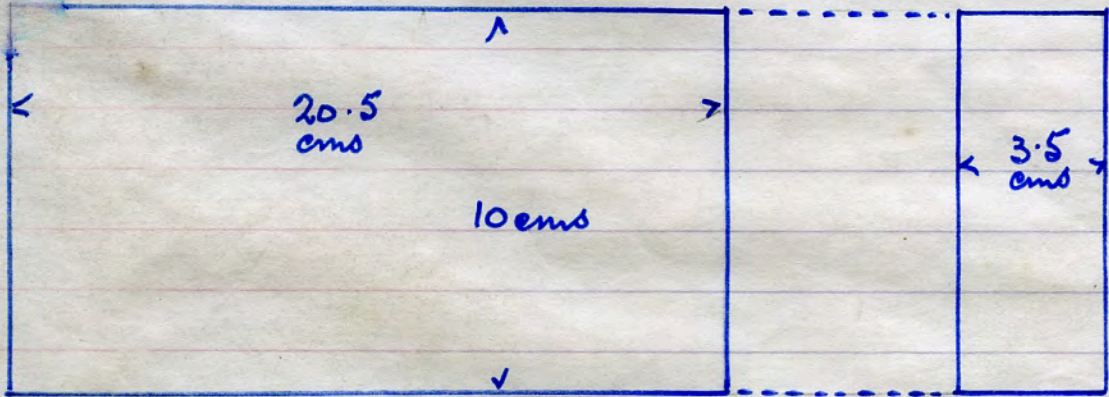

4372

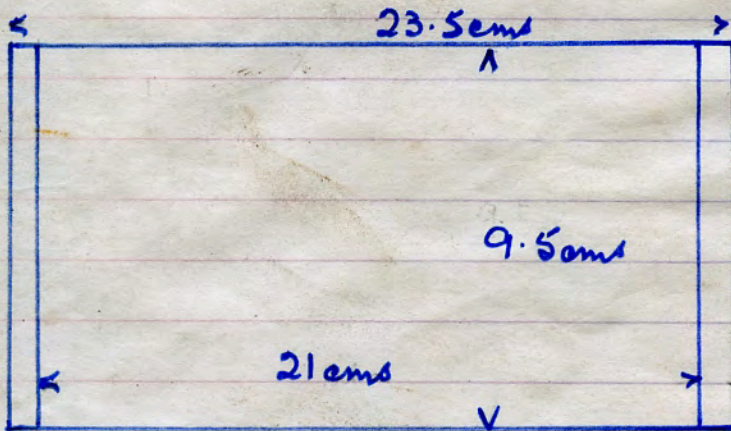

No name OZAC red T.C 4 lbs

Acc/ton Mori dem site 20. 2. '89

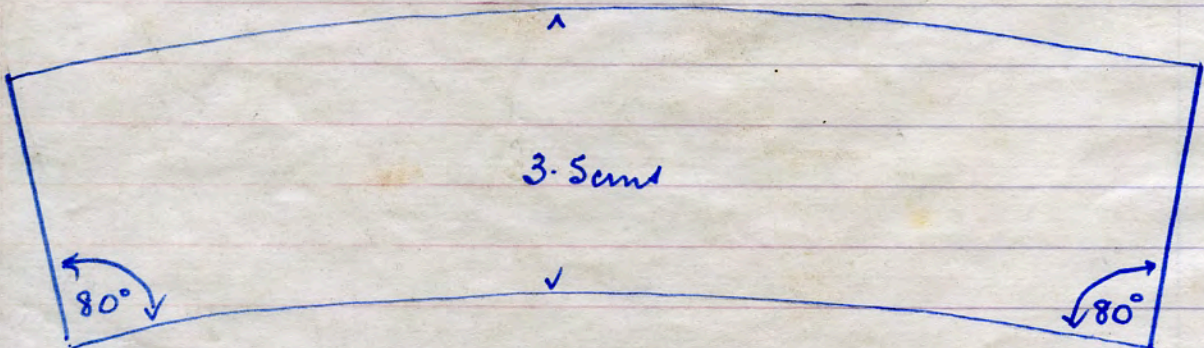

H373

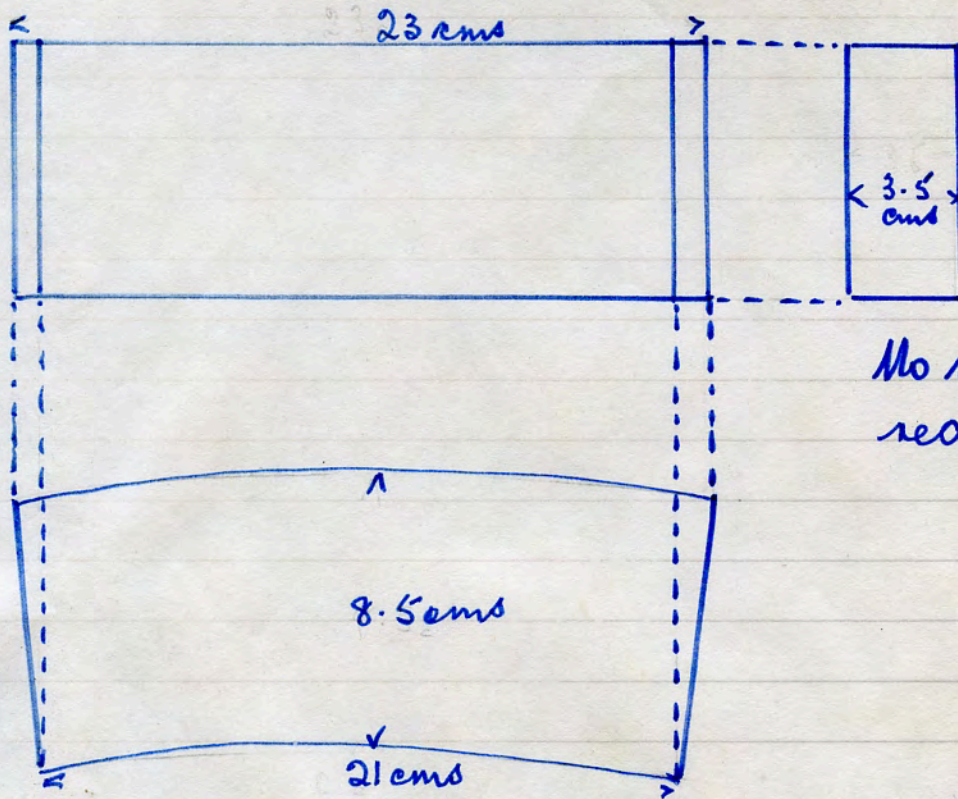

No name OZB
red T.C 3 1/2 lbs

H374

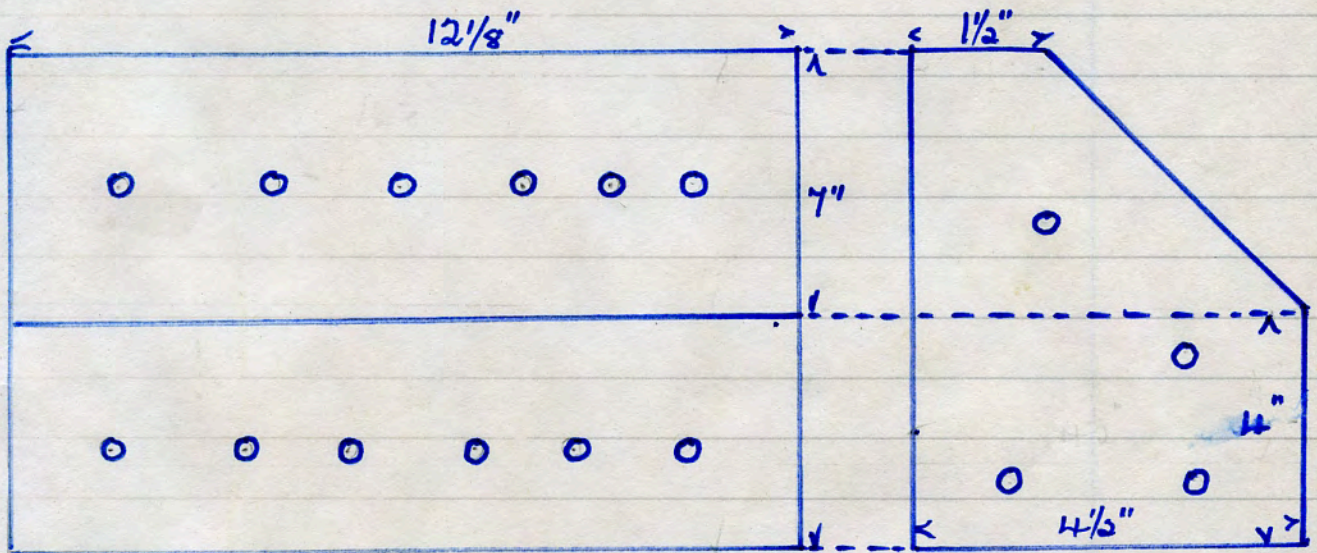

No name 987 T red T.C. 28 lbs.

21/2/89

4375

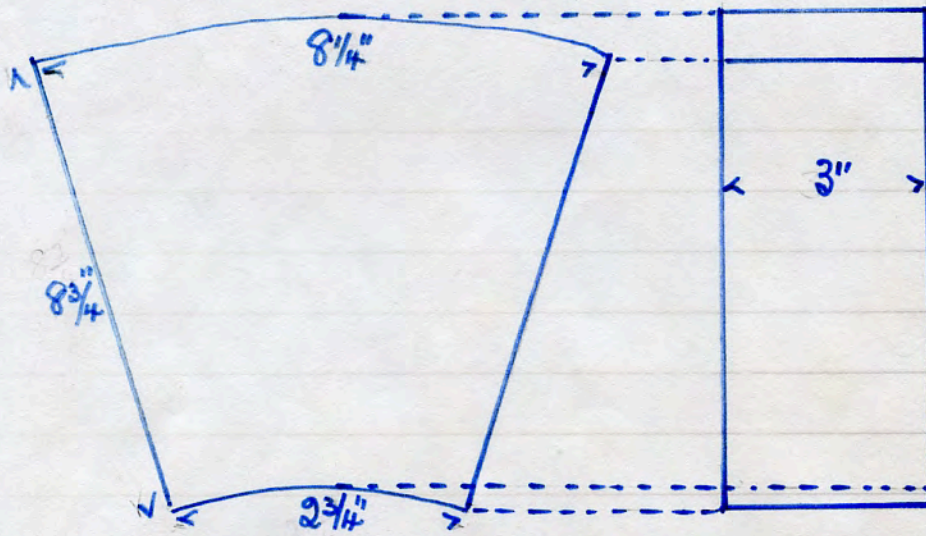

No name
 37 G 3
 red T. C
 12 lbs.
 Acc. Mori dem
 site 20. 2. '89

No name 251 1LD dark brown. 7 lbs.

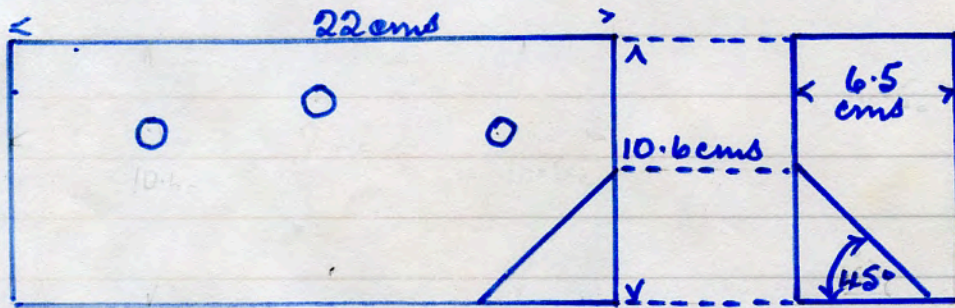

Acc. Mori
 dem. site
 22. 2. '89

No name 125 VA sand faced rustic 12 lbs

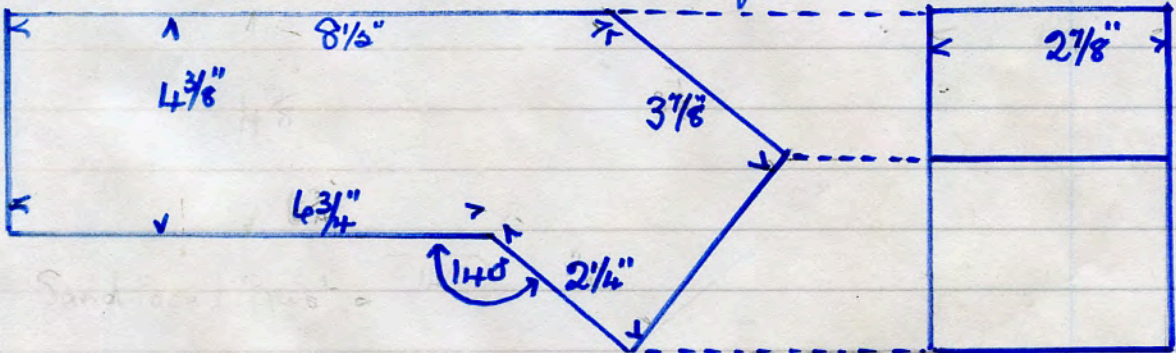

Sand faced rustic

4377

4378

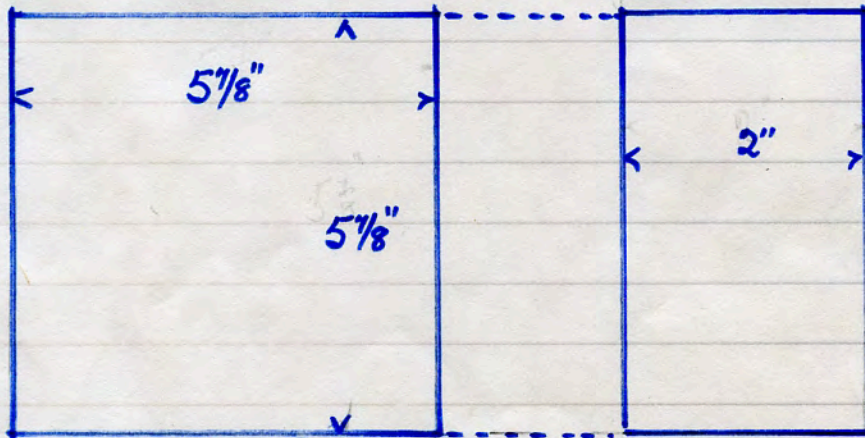

No name
 62
 red T. C
 6 1/2 lbs.

pencil mould on all axes.
 Acc. Mori dem. site 21. 2. '89

4379

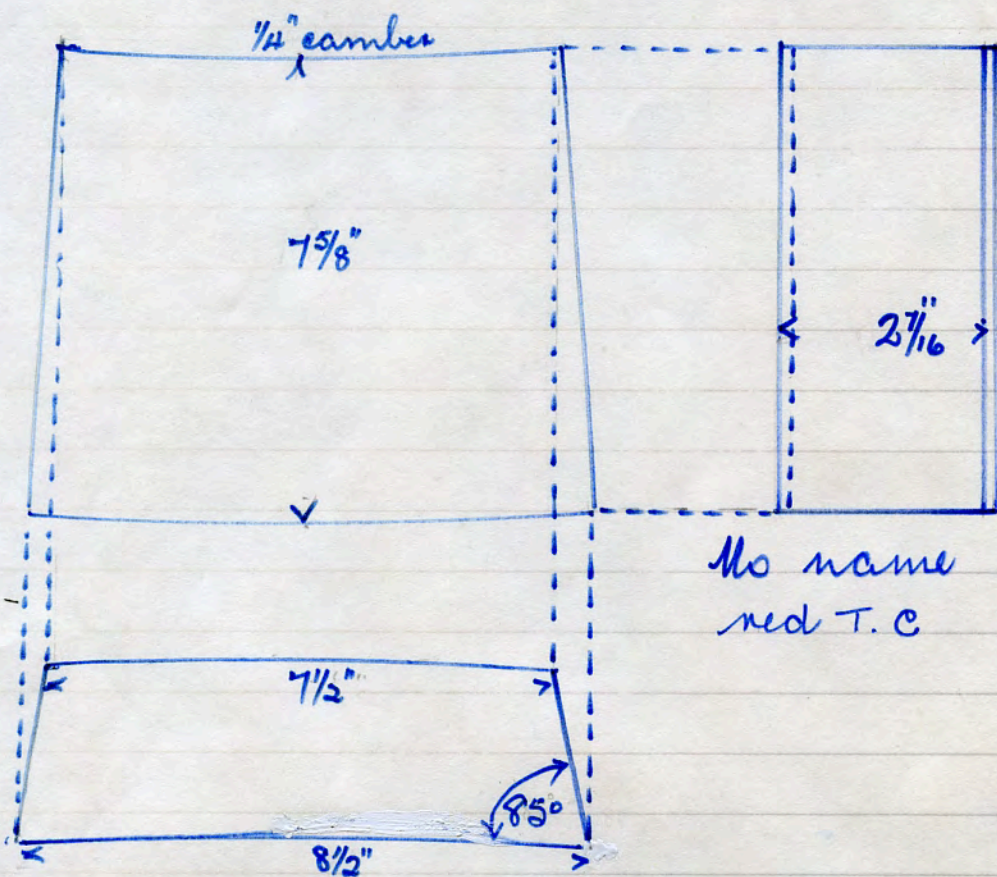

No name 99 P 29
red T.C 12 lbs.

4380

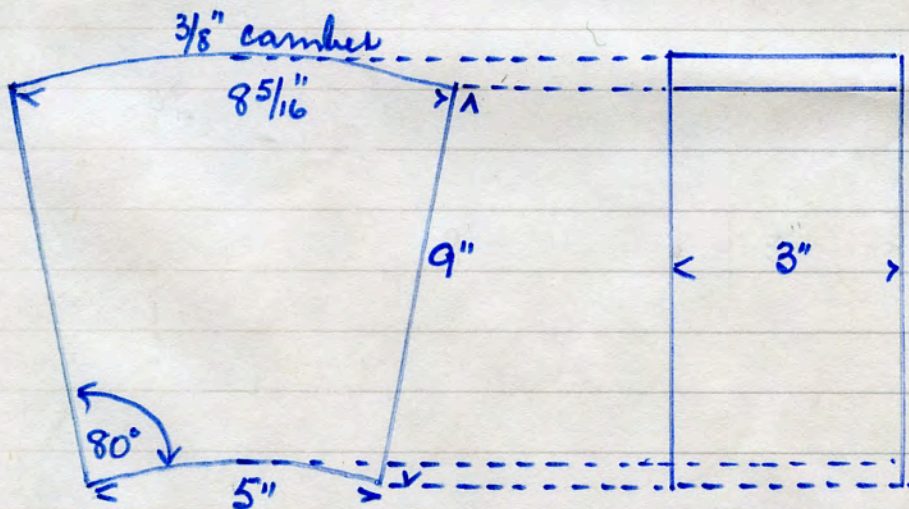

No name
91 K 70
red T.C.
14 lbs.

4381

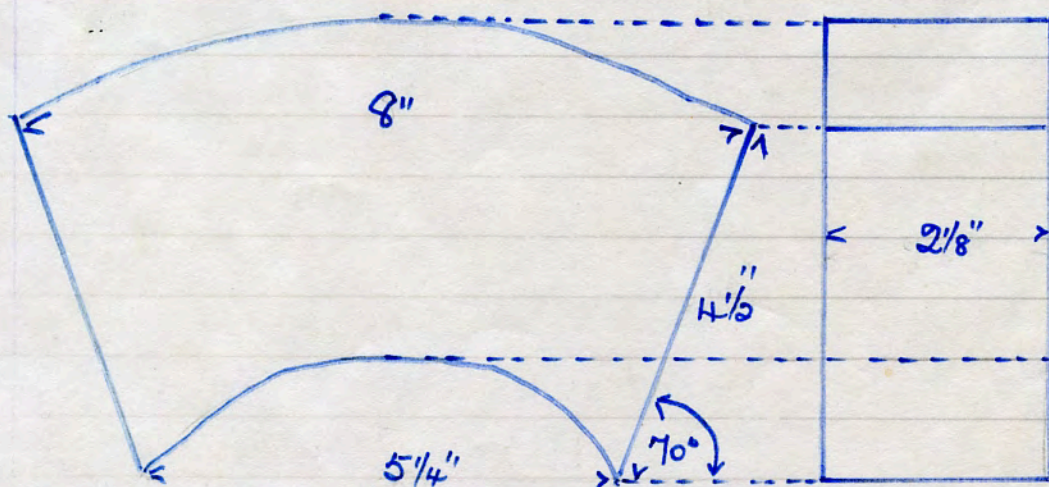

No name
OZ 46 C
red T.C
6 lbs

Acclion Mori dem. site 20. 2. '89

4382

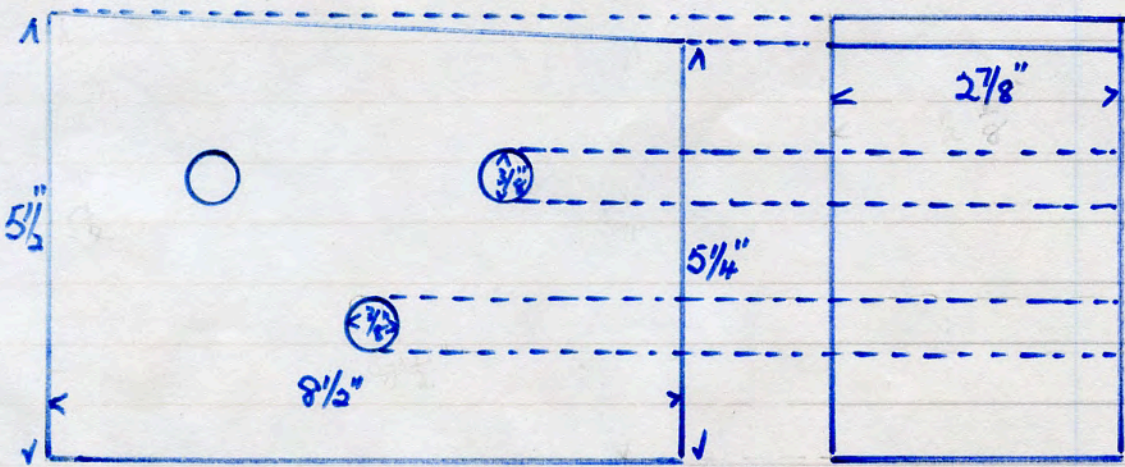

No name 40 P 11 red T.C. 12 lbs

4383.

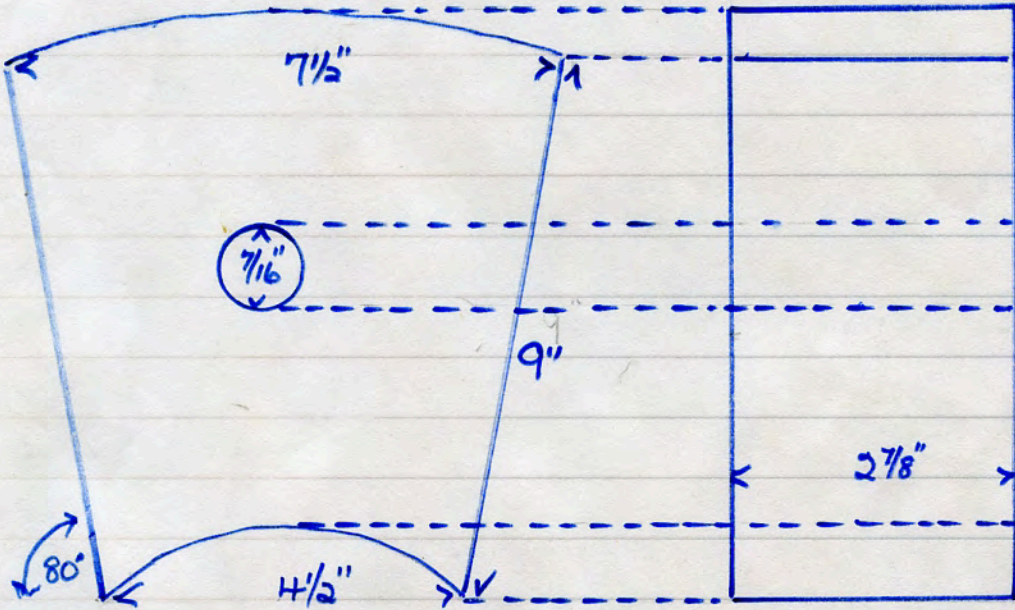

No name 1X 93 red T.C. 12 lbs

4384

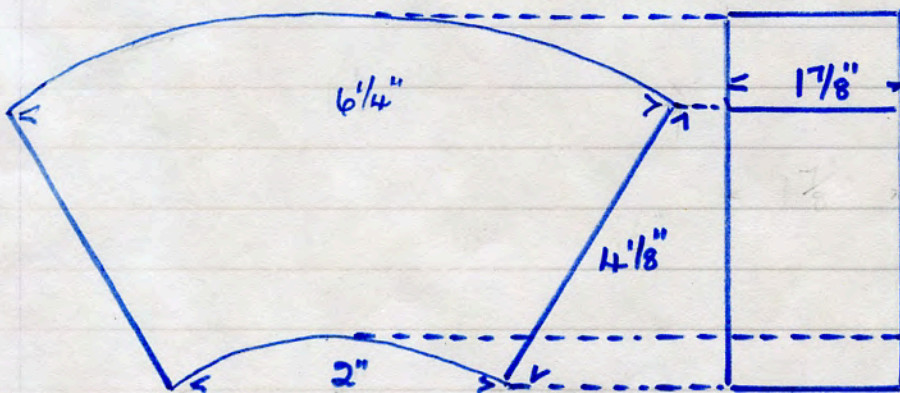

No name 2302 red T.C. $3\frac{3}{4}$ lbs
moulder's mark HT.

Acceptor More dem. site 20. 2. '89 + 21. 2. '89

No name 55 M 53. red T.C. 6lbs.

Accepton Mori dem. site 20. 2. '89

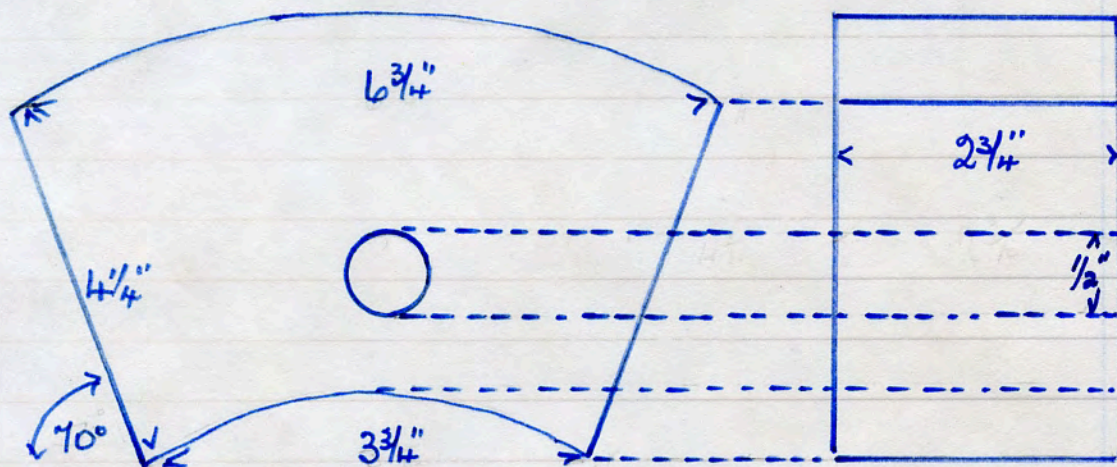

4385

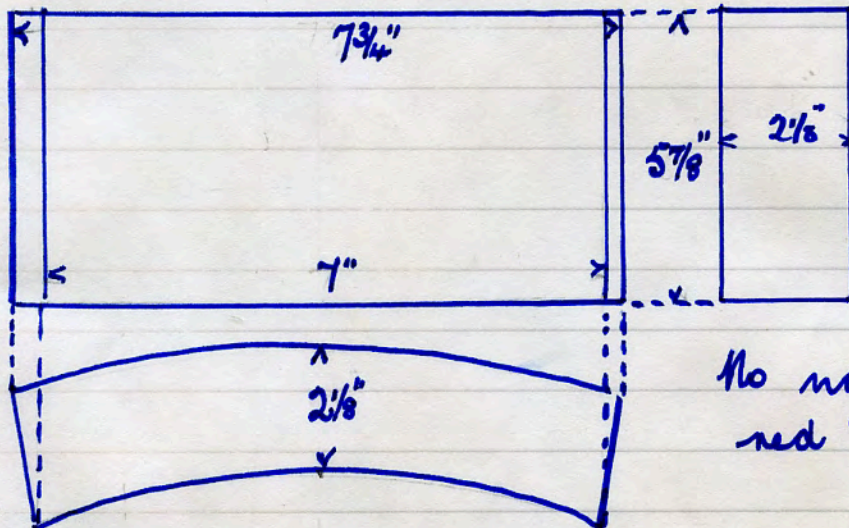

4386

No name 12 H
red T.C. 8 lbs

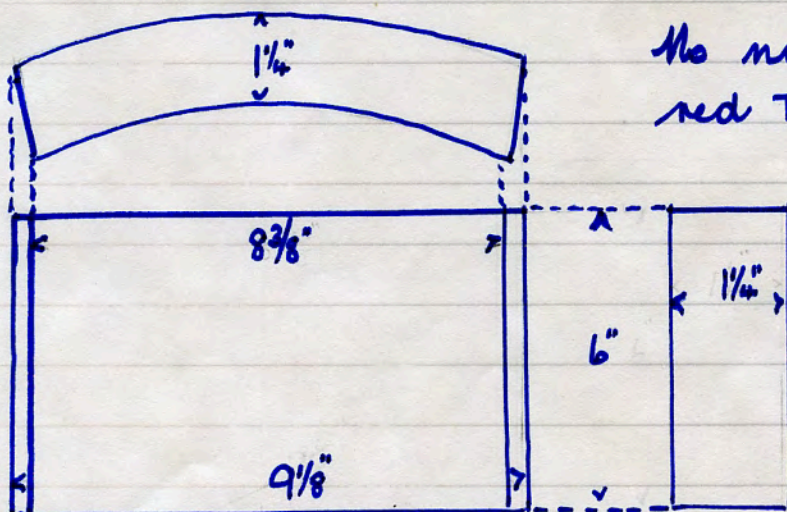

4387

No name OZA
red T.C. 5 lbs

Accepton Mori dem. site 22. 2. '89

Acclton Mori dem. site 22. 2. '89

No name

25 M 13
red T.C
6lbs

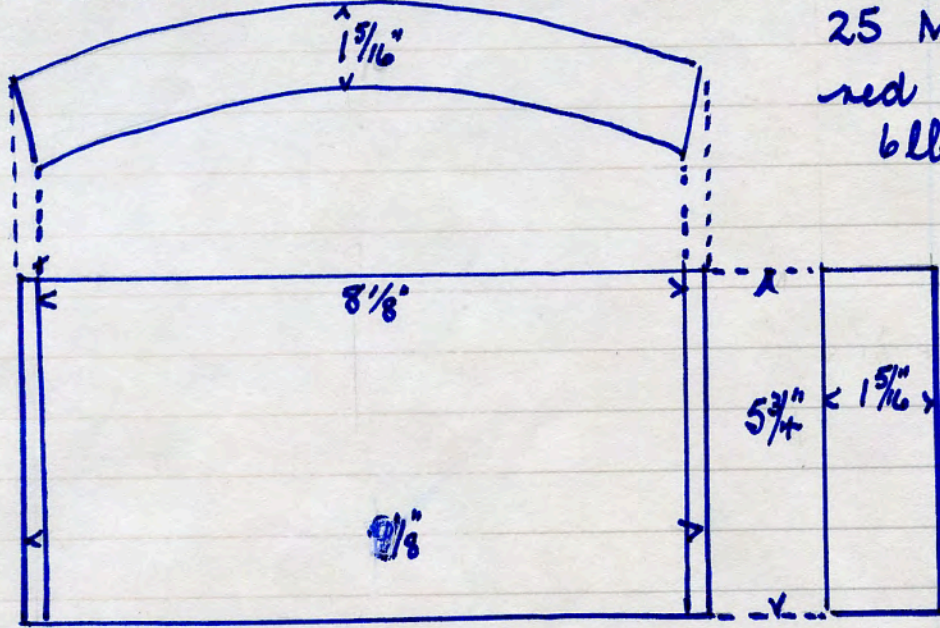

4388

No name

70

red T.C.
5 1/2 lbs

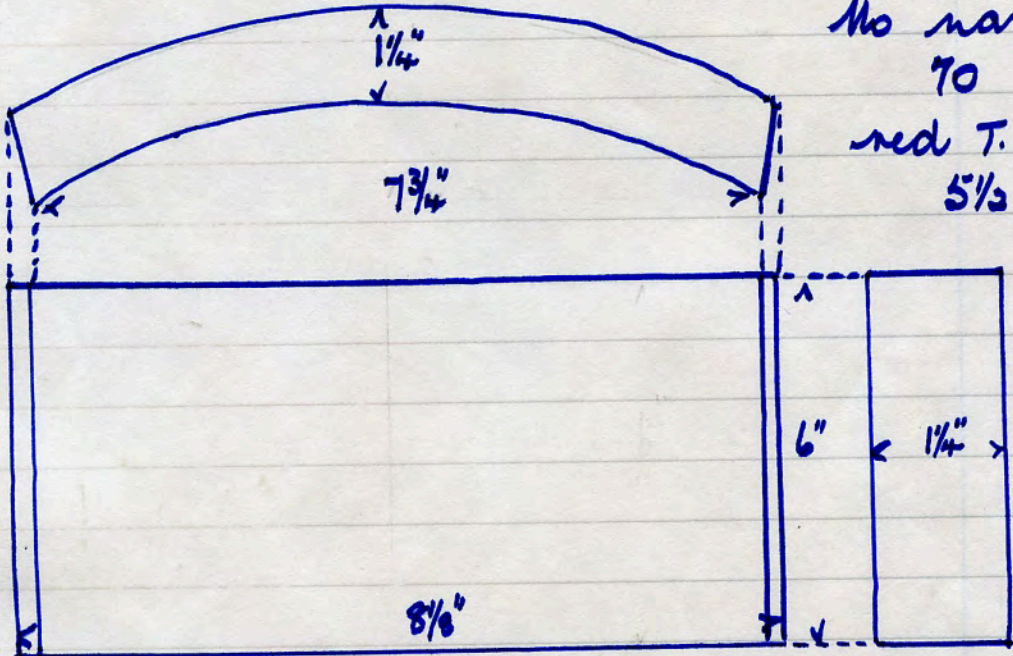

4389

No name 10 K 1

red T.C. 5 1/2 lbs
23. 2. '89

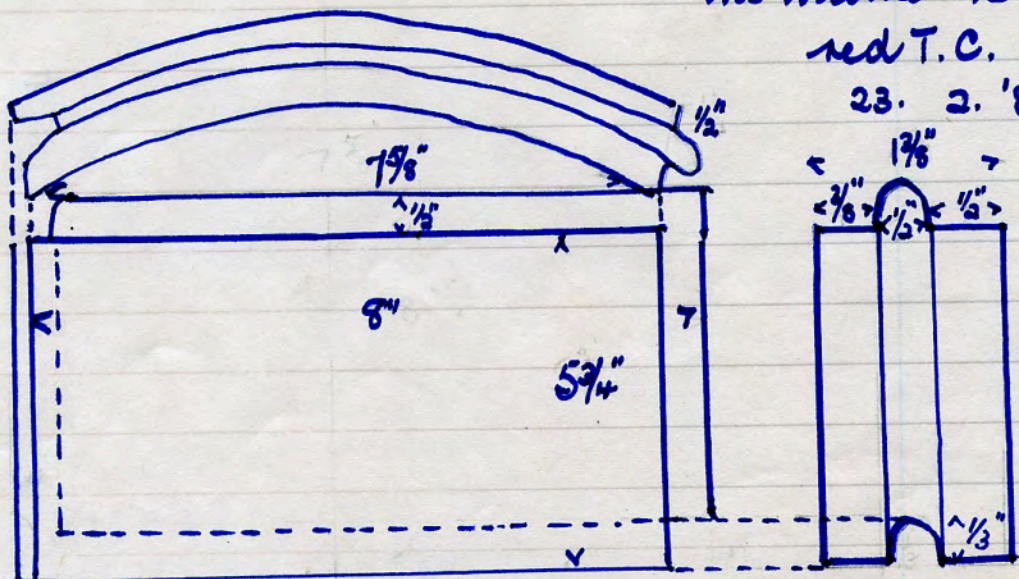

4390

4391

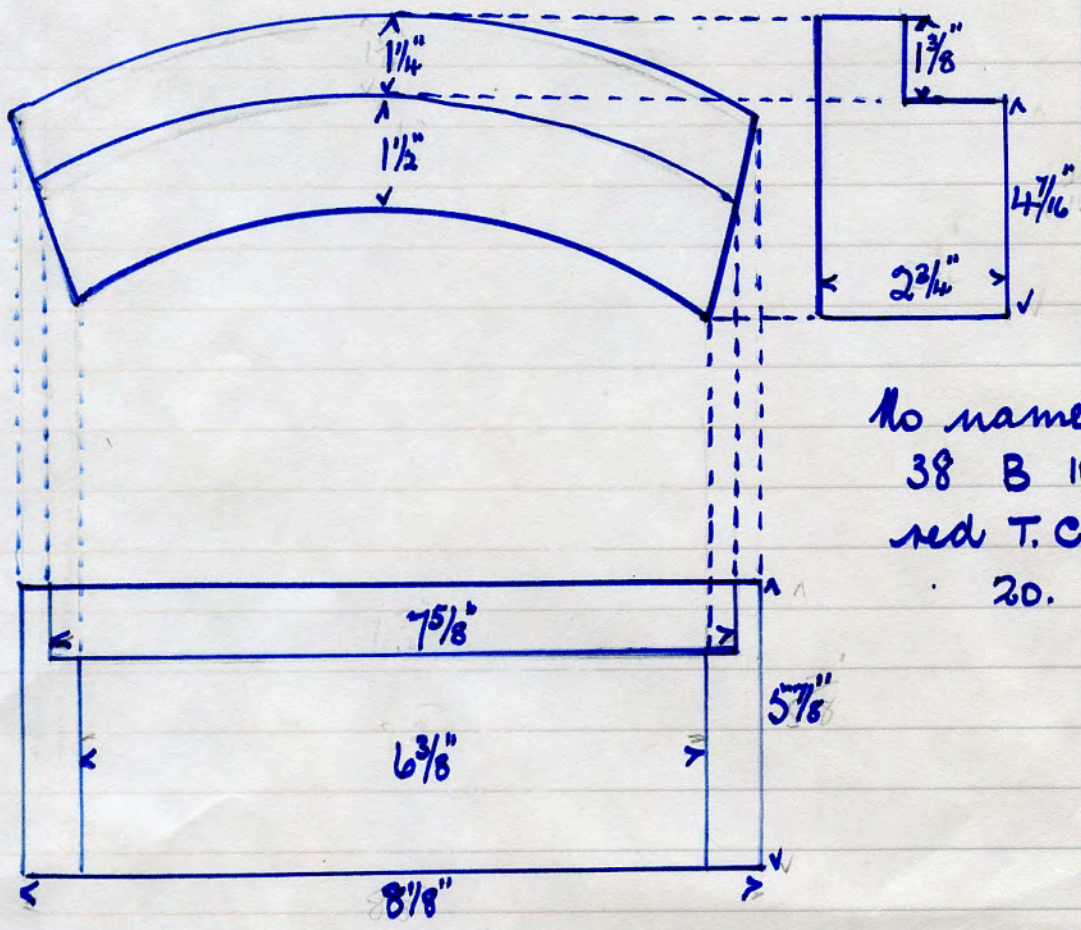

no name
 38 B 10A
 red T.C. 8 lbs.
 20. 2. '89

20. 2. '89

no name 31 P 295 red T.C. 6 3/4 lbs with J1.

4392.

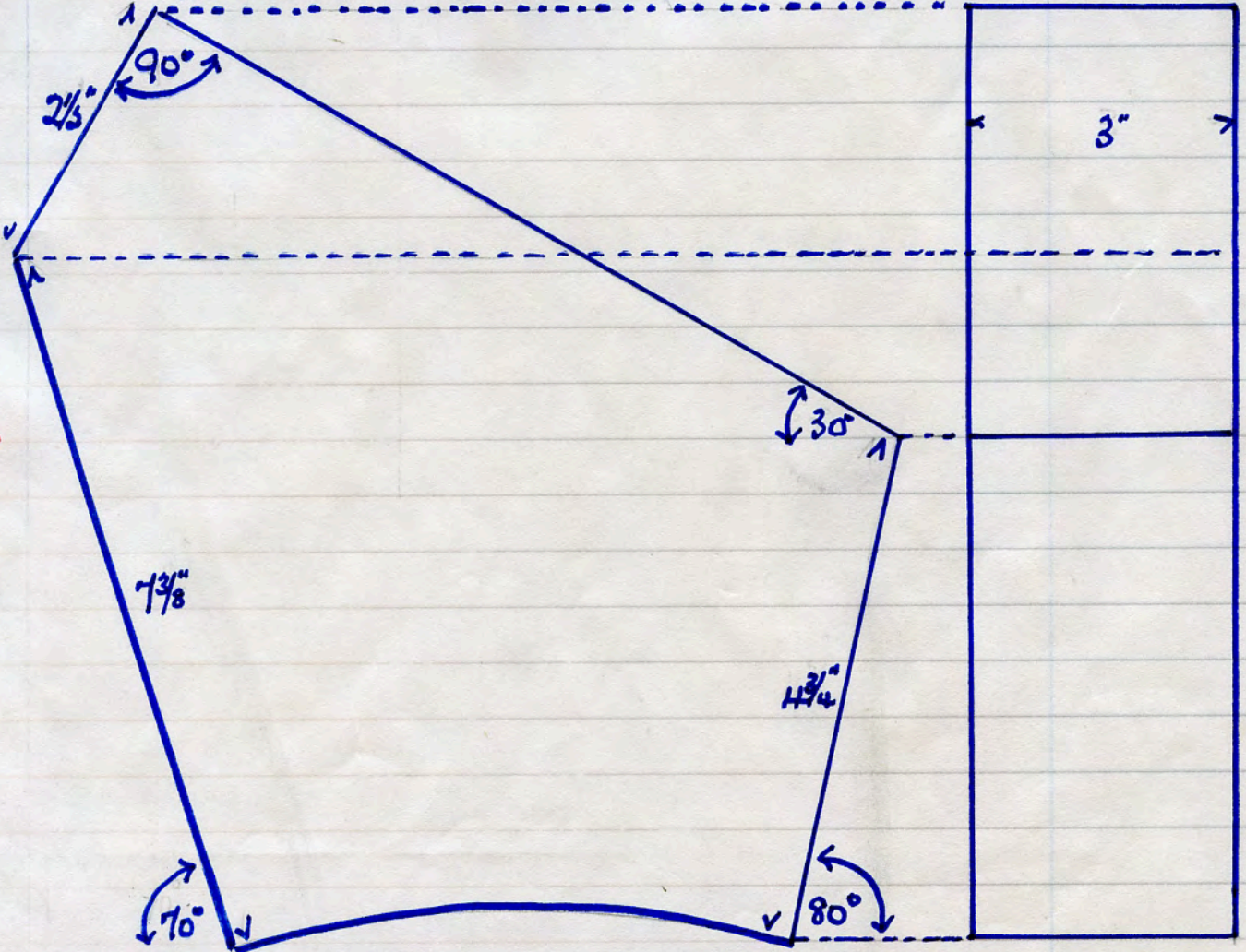

PLAN

$1\frac{7}{8}$ "

$2\frac{7}{8}$ "

$3\frac{1}{8}$ "

FRONT
ELEVATION

4393

$5\frac{5}{8}$ "

$6\frac{5}{8}$ "

No name 73 Q 192 red T. C. 4 lbs
Acceptor Hosi dem. site 20. 2. '89

4394

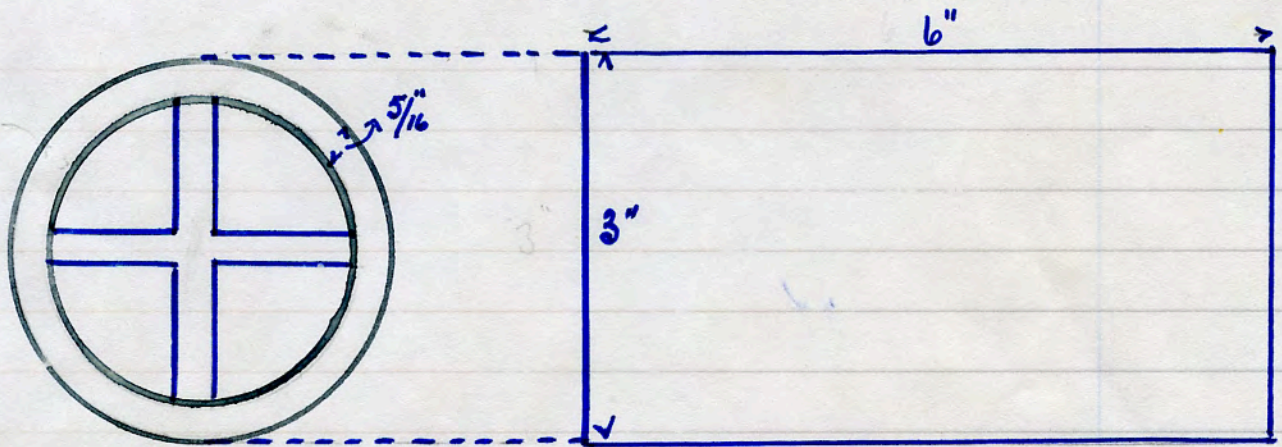

No name. no number red T.C 1 lb
 Accton Nori dem. site 22. 2. '89

4395

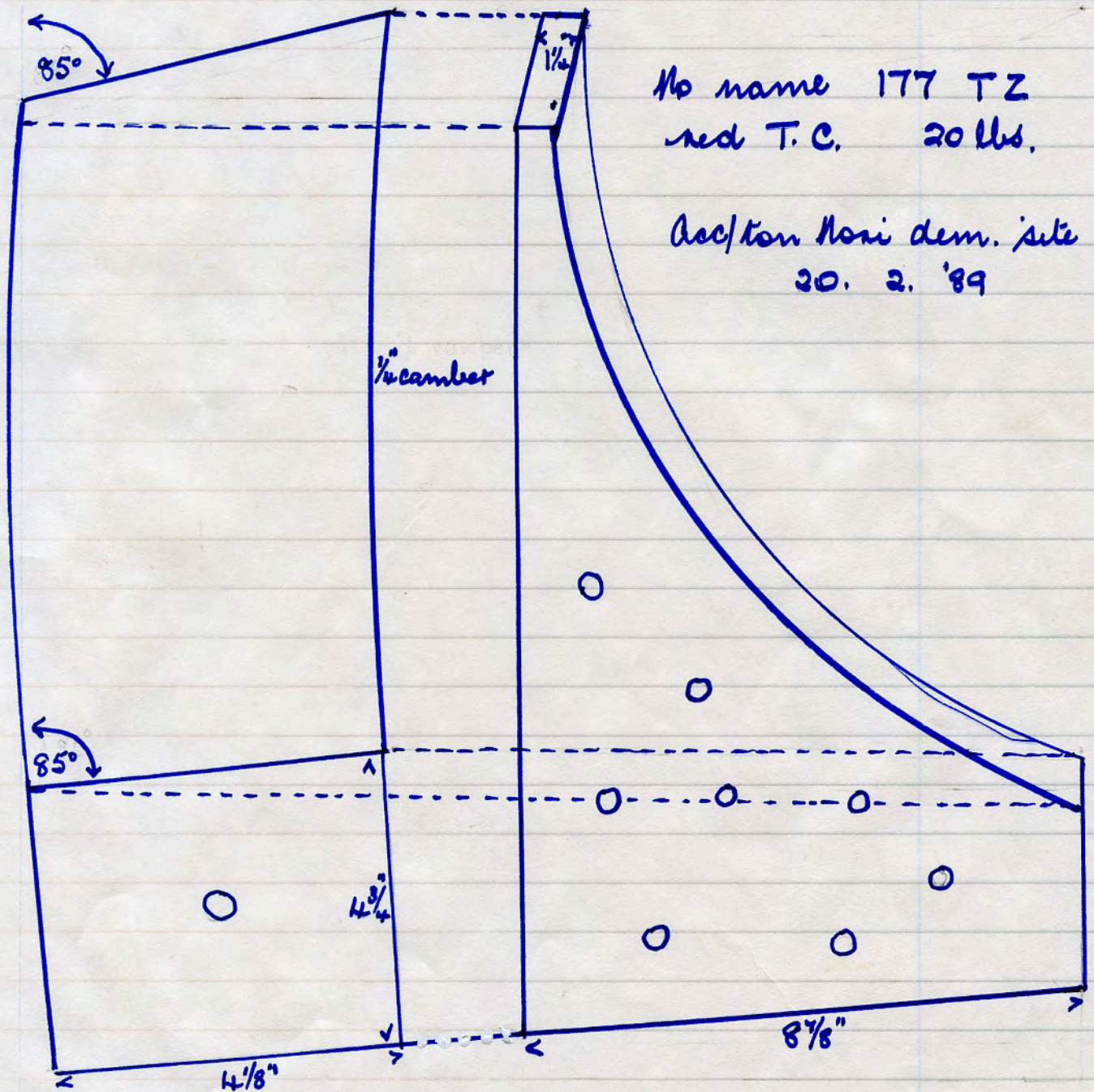

No name 177 TZ
 red T.C. 20 lbs.

Accton Nori dem. site
 20. 2. '89

4396

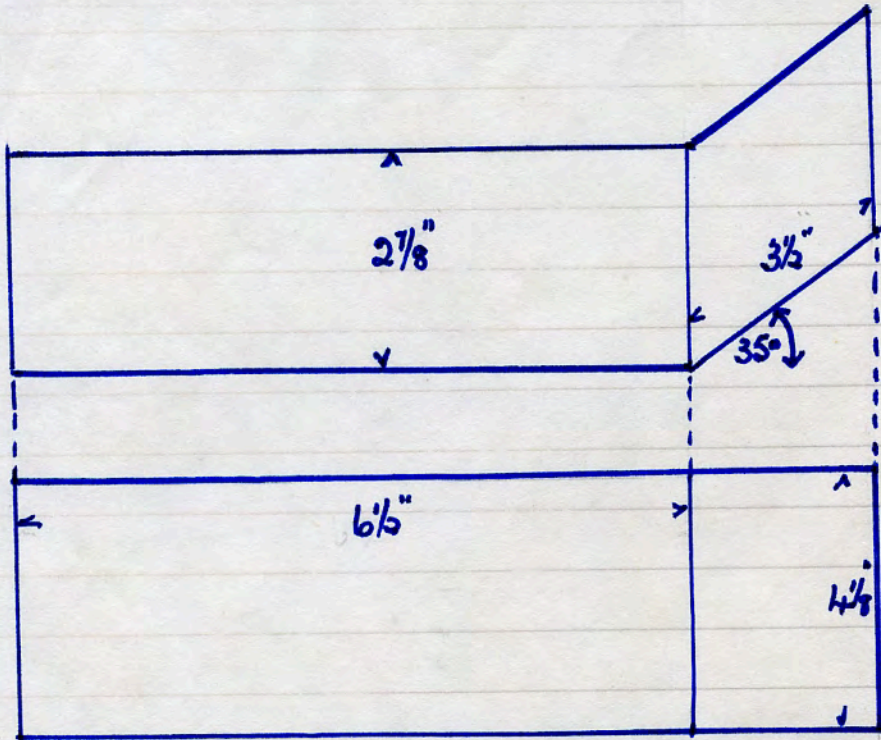

No name
 JS
 red T.C.
 8 1/2 lbs.
 21. 2. '89

4397

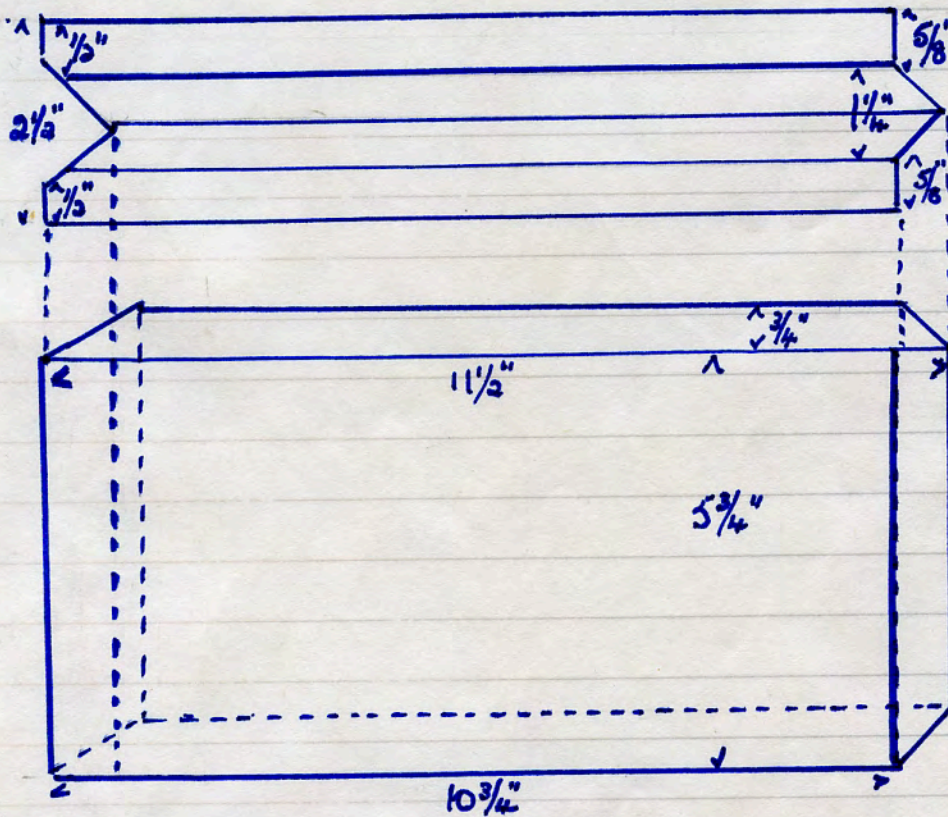

No name
 H H
 red T.C.
 13 1/2 lbs.

Acfton Maxi dem. site 23. 2. '89

4398

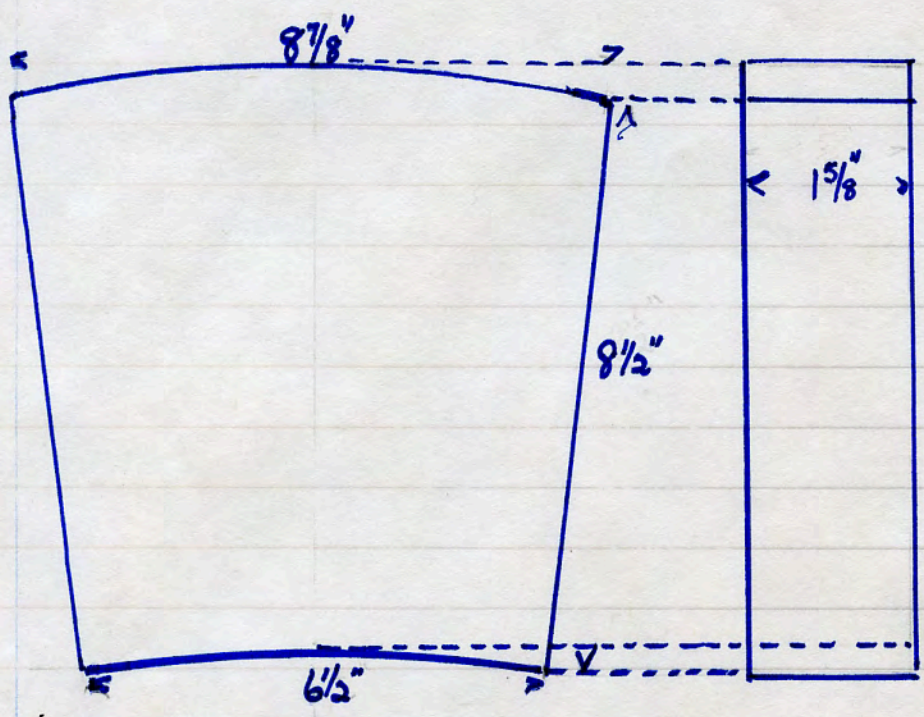

No name
 8904
 red T. C.
 8 lbs.

Acc. Mori dem. site
 21. 2. '89

4399

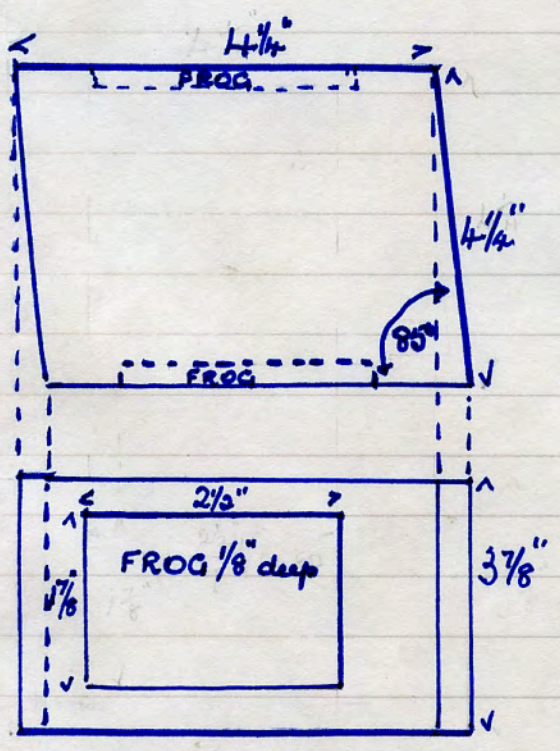

No name 371 W 172 X
 red T. C. 5 lbs.

Acc. Mori dem. site
 20. 2. '89

No name 262 T. red T.C. 81 lbs. 26. 2. '89

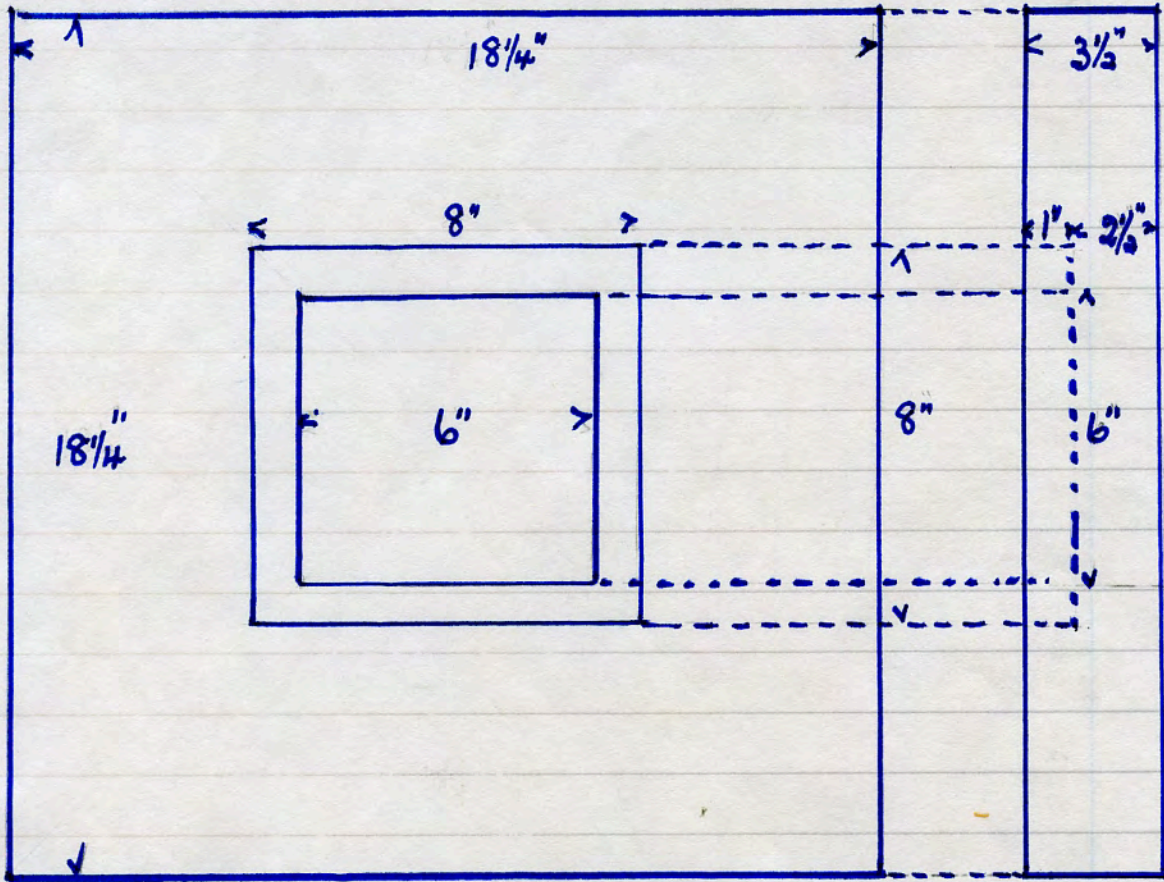

4400

4401

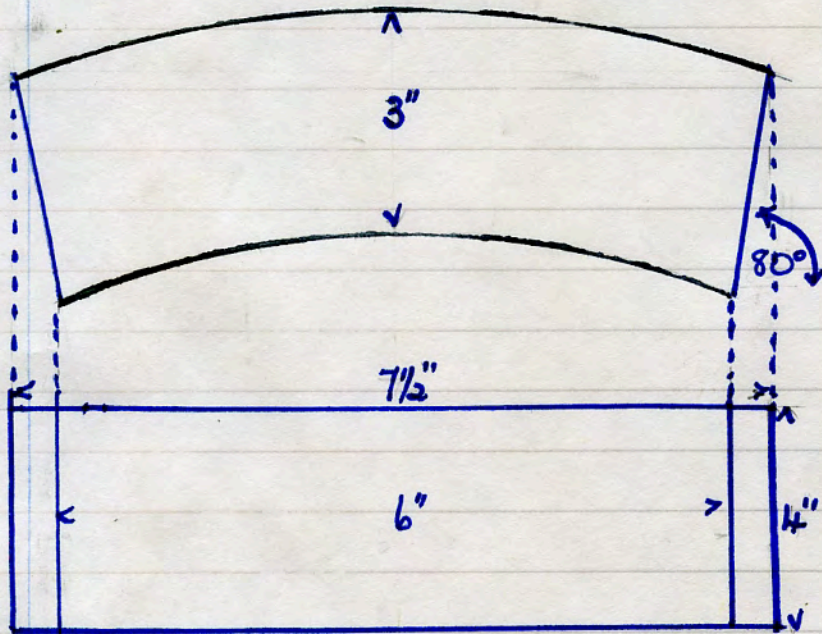

No name 10 R
red T.C. 7 lbs.

Acfton Mori dem. site
22. 2. 89.

H402

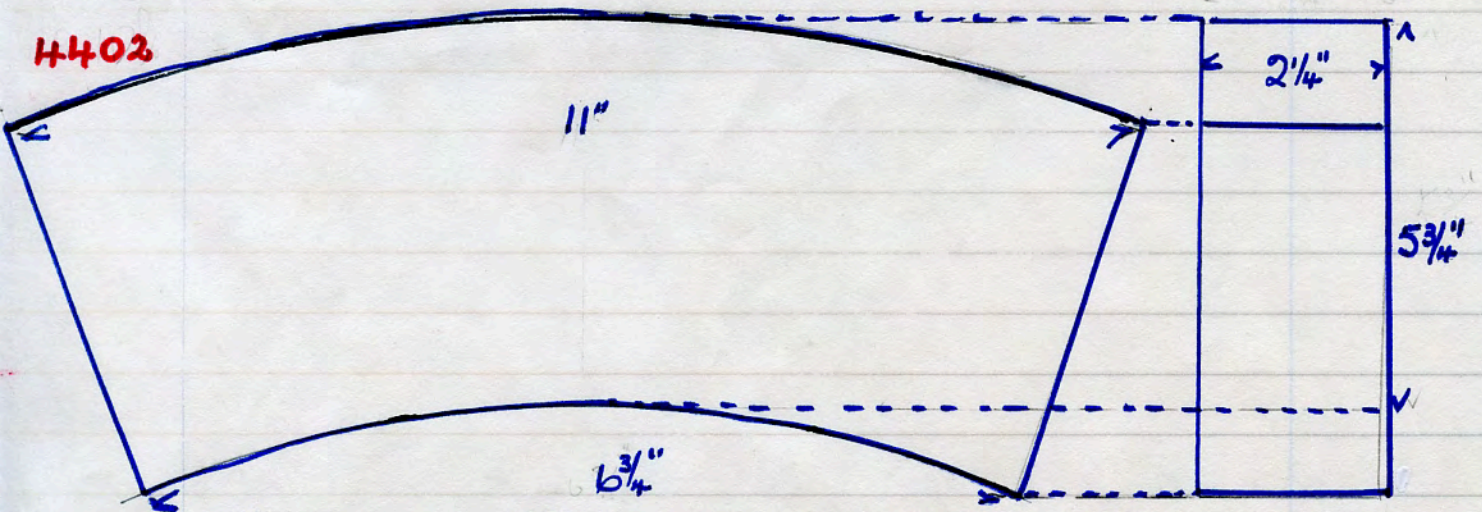

No name 38 B 17 red T.C. 10 lbs

H403

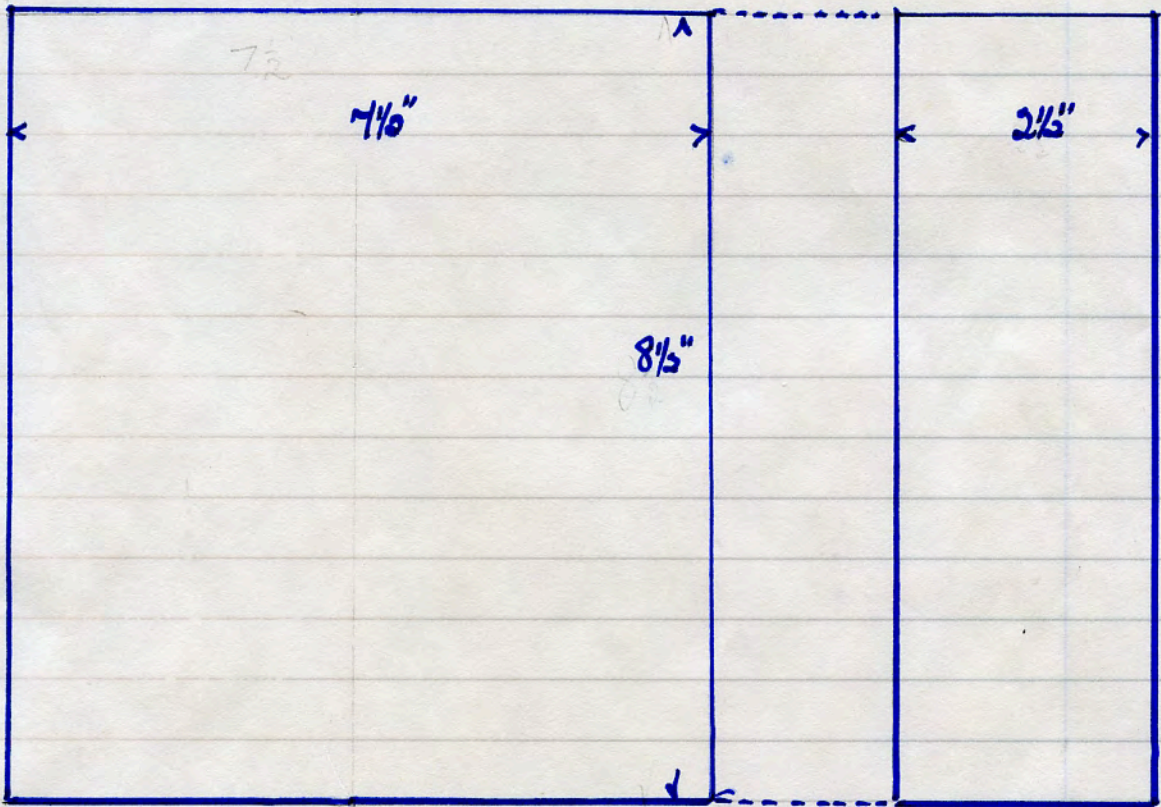

No name 12 Q 29 red T.C. 13 lbs. mm. TH.

Auction Mosi dem. site 21. 2. '89

No name 783 WDL red T.C. 7 lbs

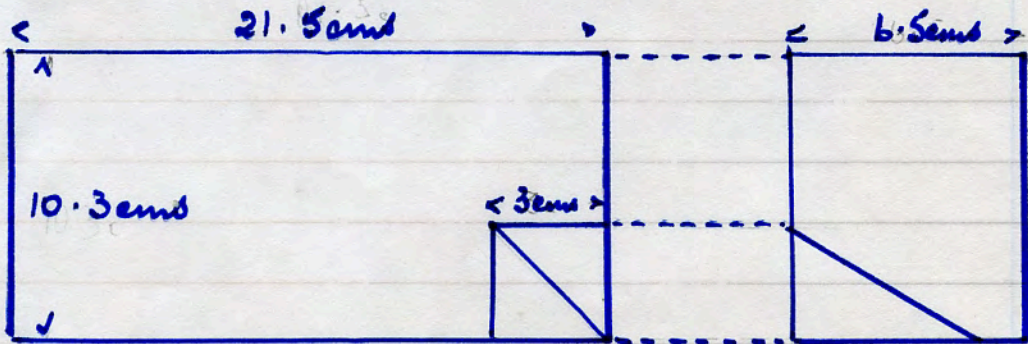

H404

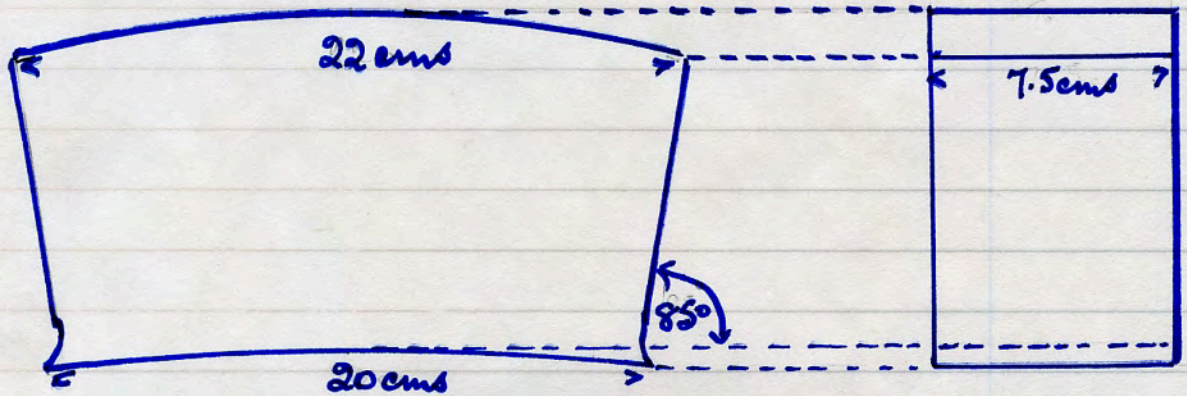

H405

No name. 27. engineering brick. 9 lbs

No name 18 engineering brick 8 1/2 lbs.

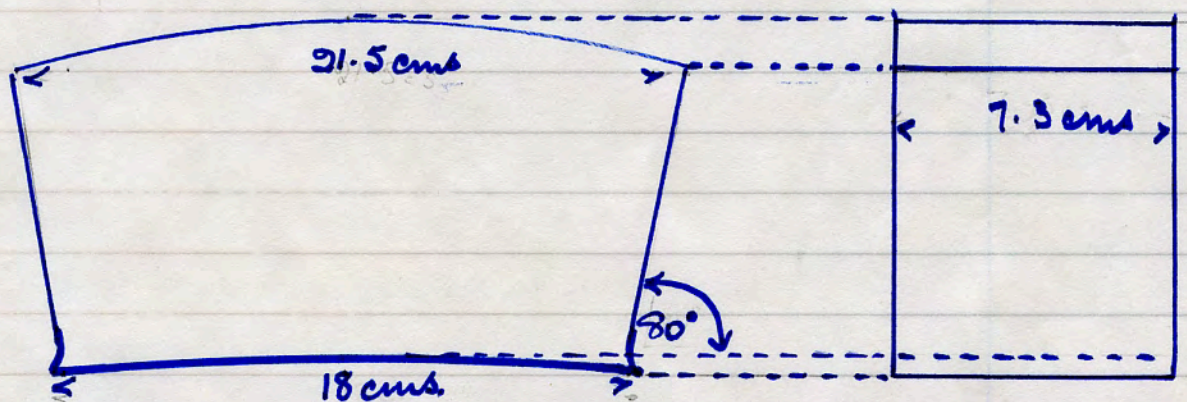

H406

Acpton Mori dem. site 22. 2. '89

No name OZE red T.C. 5 lbs

H407

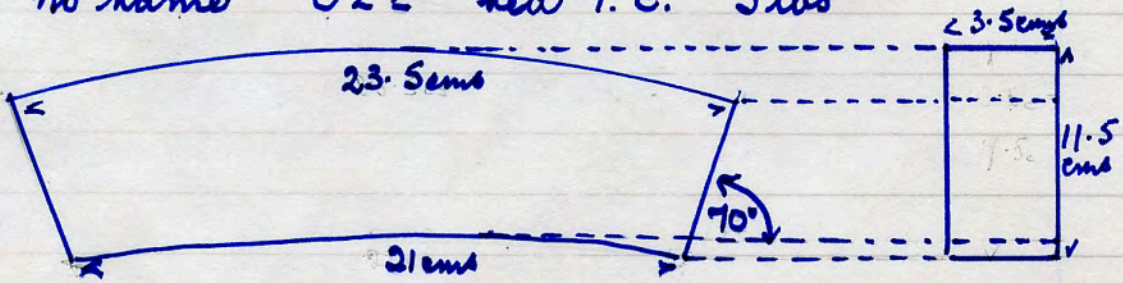

No name OZC red T.C. 2 1/2 lbs

H408

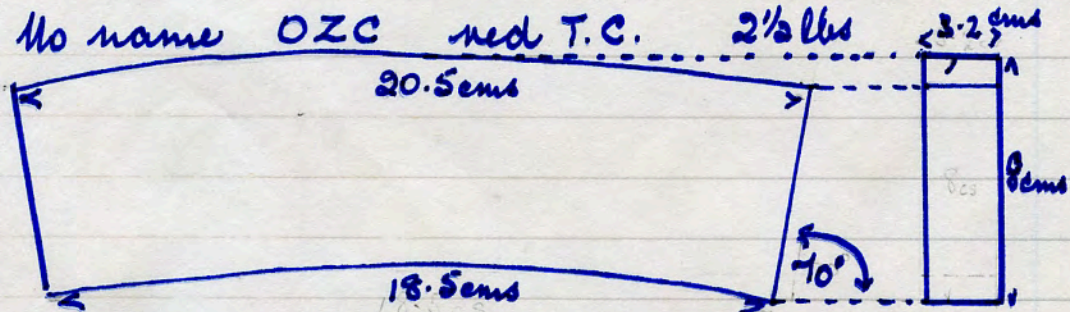

No name 38 B 11 A red T.C. 2 1/2 lbs

H409

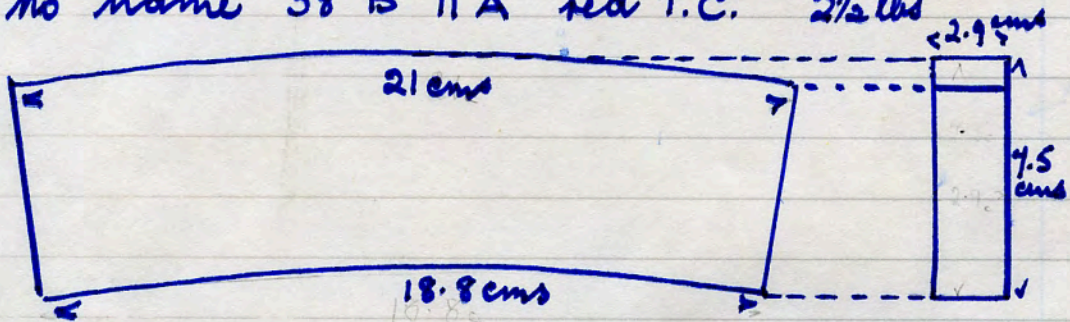

No name 38 L 4 5 red T.C. 7 lbs

H410

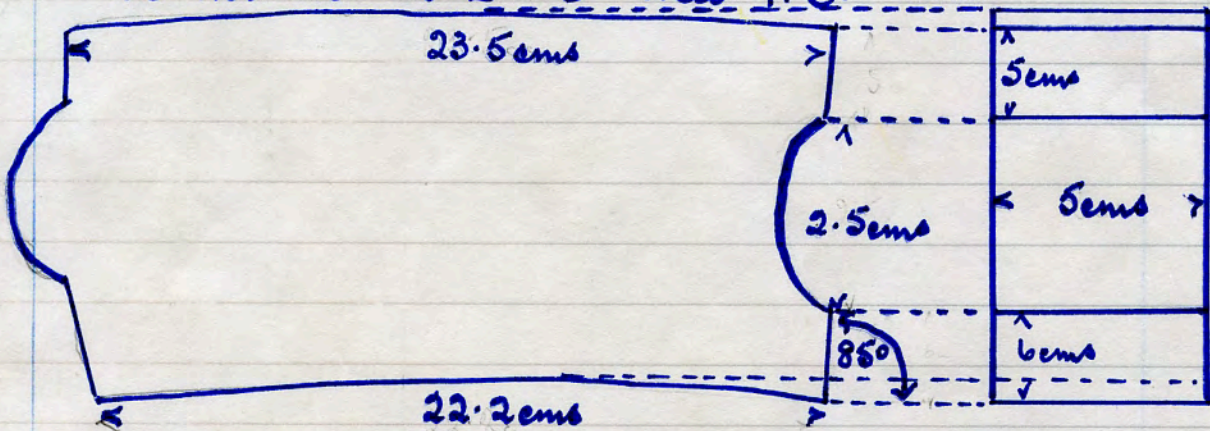

Orleton Moss dem. site 21. 2. '89

4411

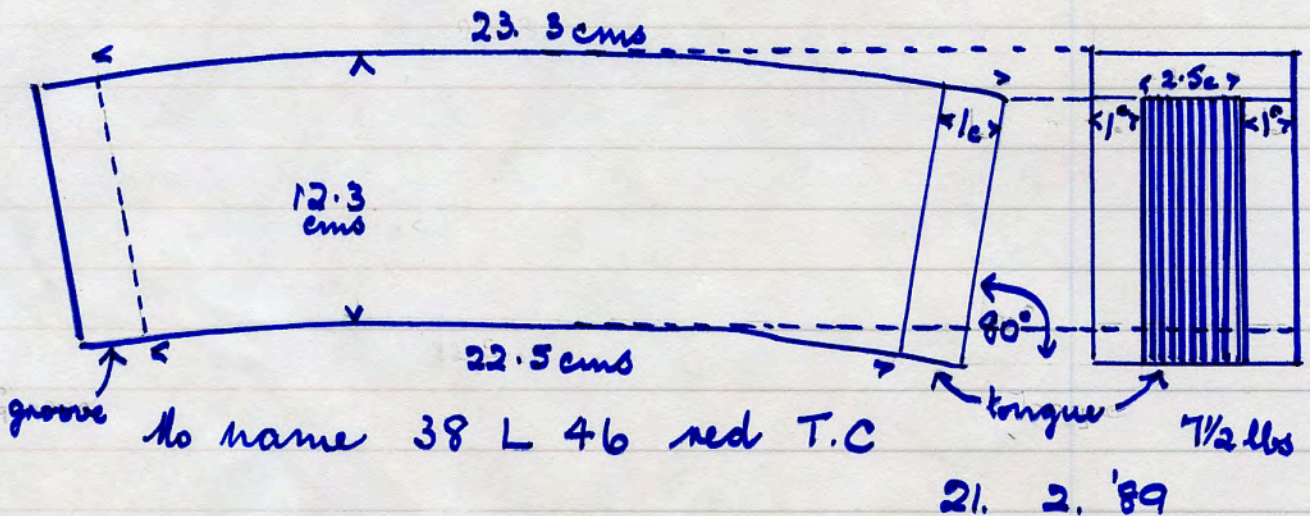

4412

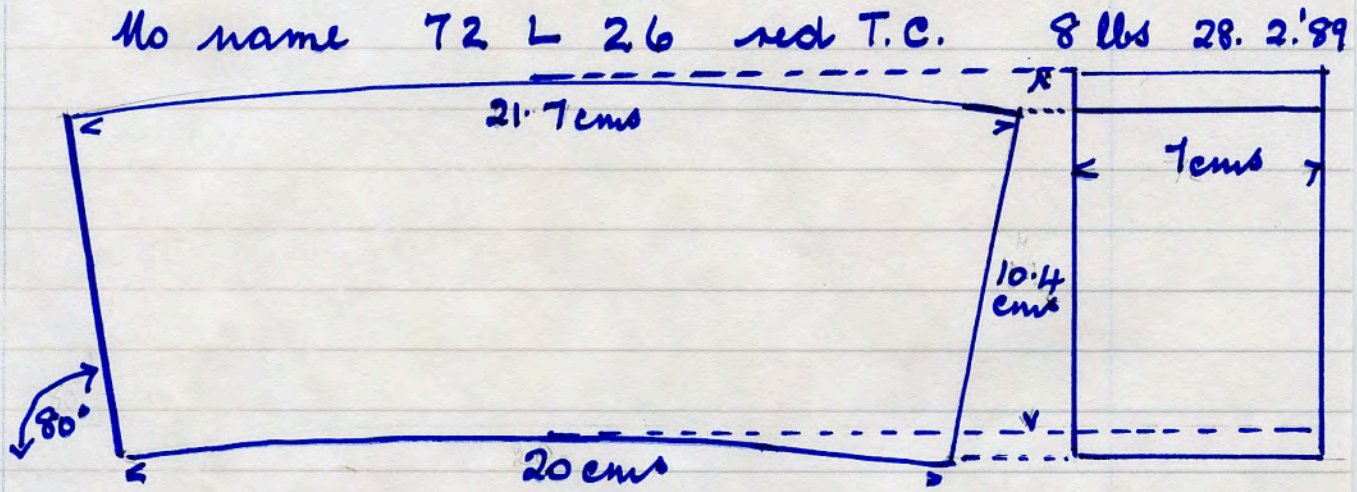

4413

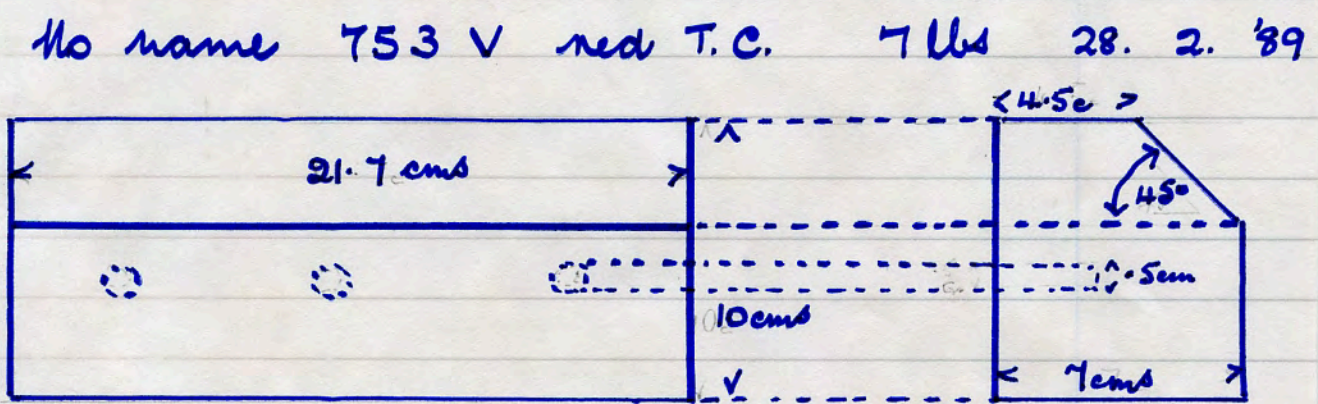

4414

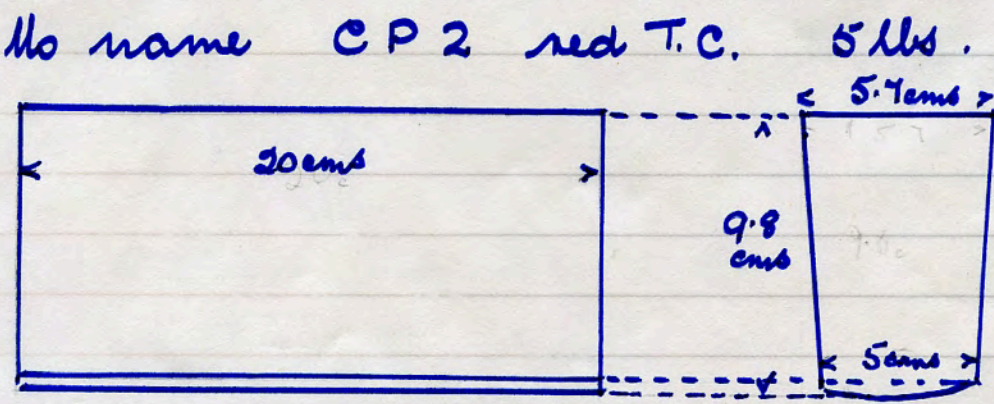

Acceptor Mosi dem. site 26. 2. '89

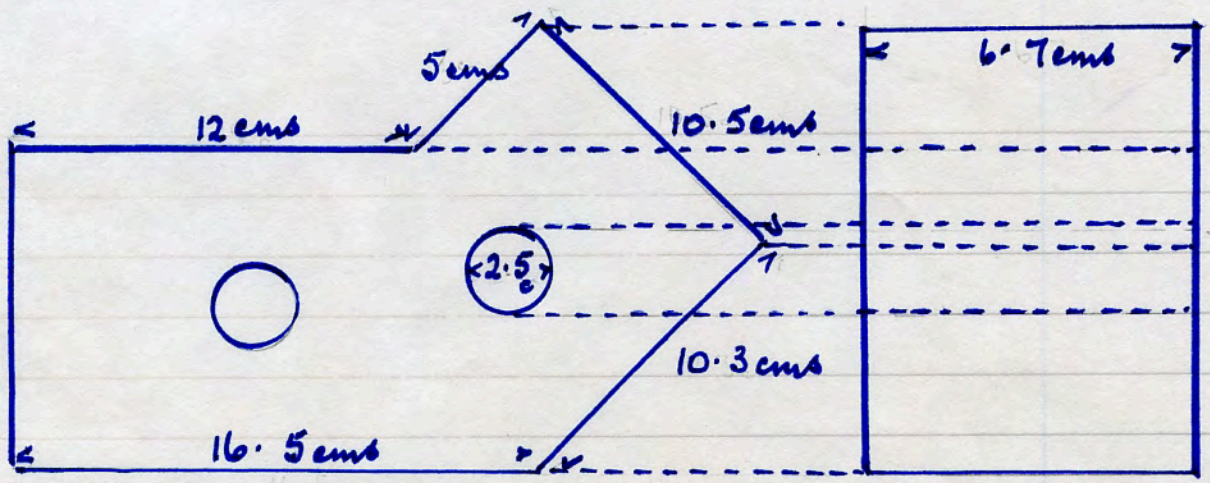

4415

No name 24 22 red T.C. 7 1/2 lbs. 28. 2. '89

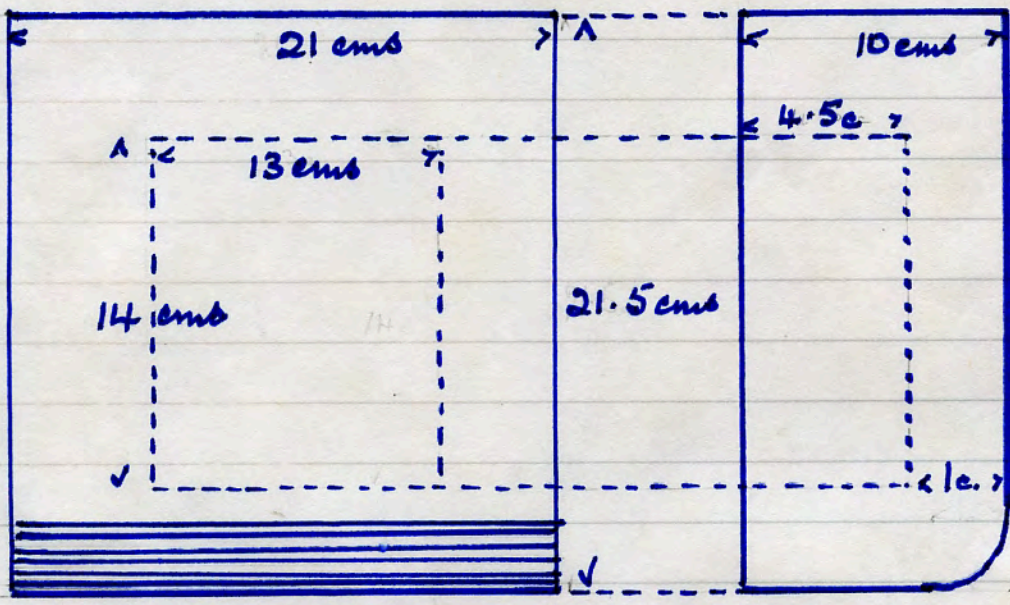

4416

No name
120 T
red T.C
20 lbs
26. 2. '89

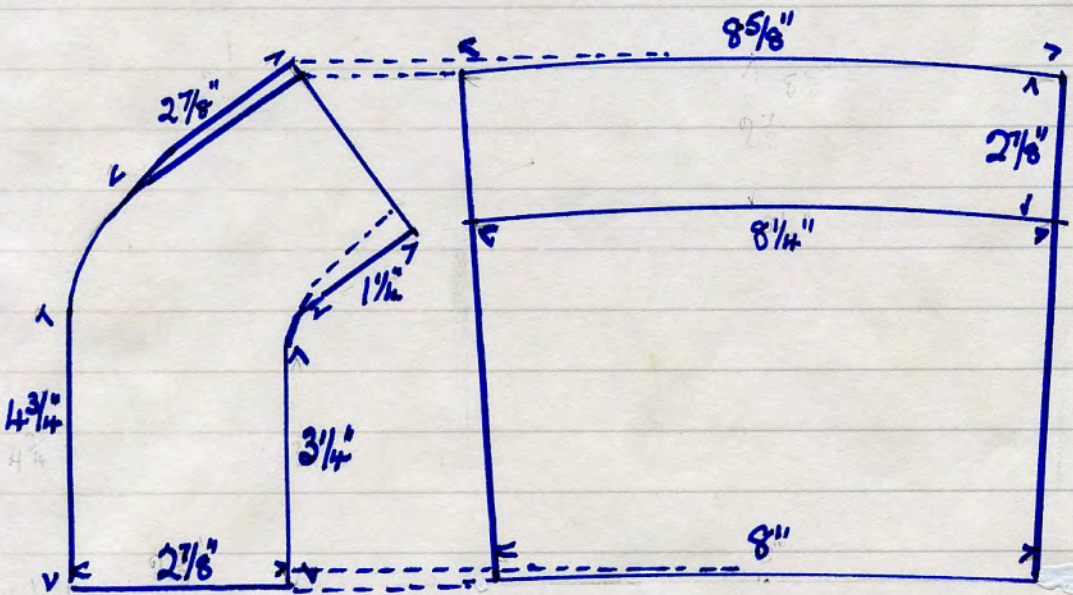

4417

No name 864 U 19 red T.C. 14 lbs.
moulder's mark P
Accton Mosi dem. site 28. 2. '89

4418

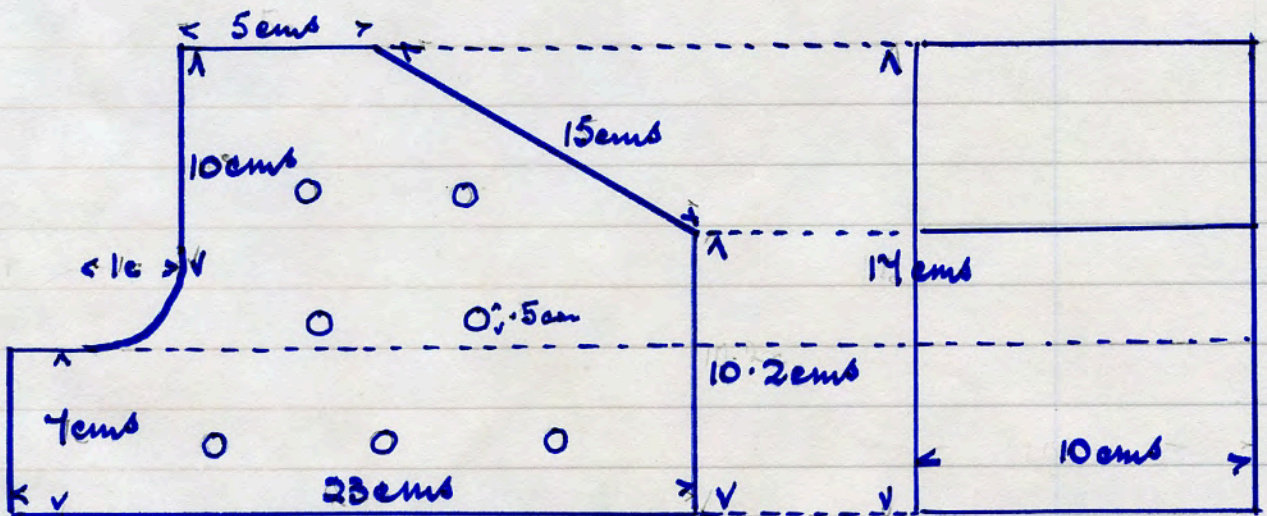

No name 864 UE red T.C. 16 lbs. m.m. T.

28. 2. '89

4419

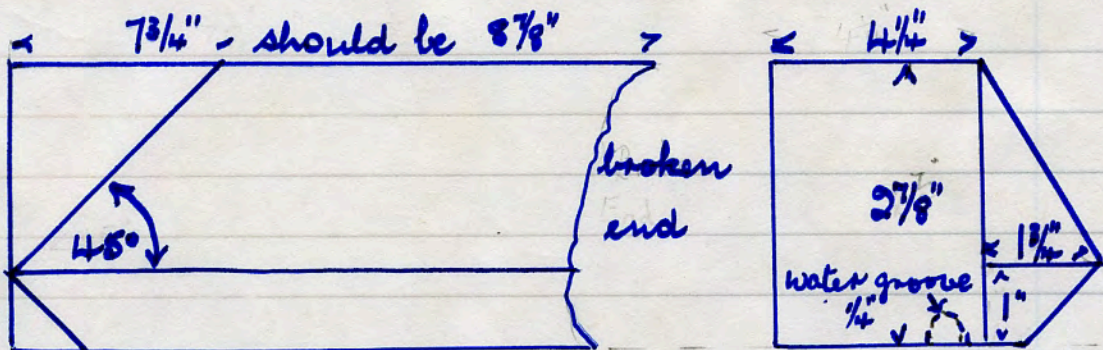

No name L 12 catalogue no. (Camfield Book Co)

red T.C. 8 1/2 lbs

17. 2. '89

4420

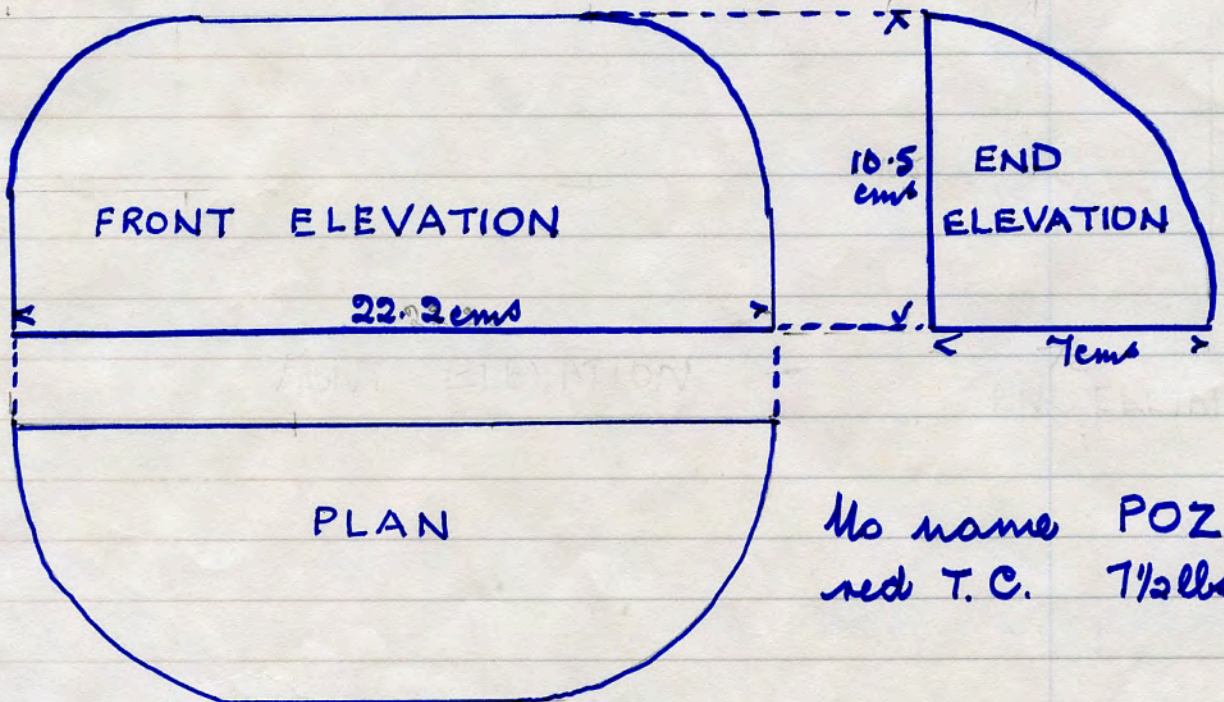

No name POZSR
red T.C. 7 1/2 lbs

Acpton Mori dem. site. 26. 2. '89

H421

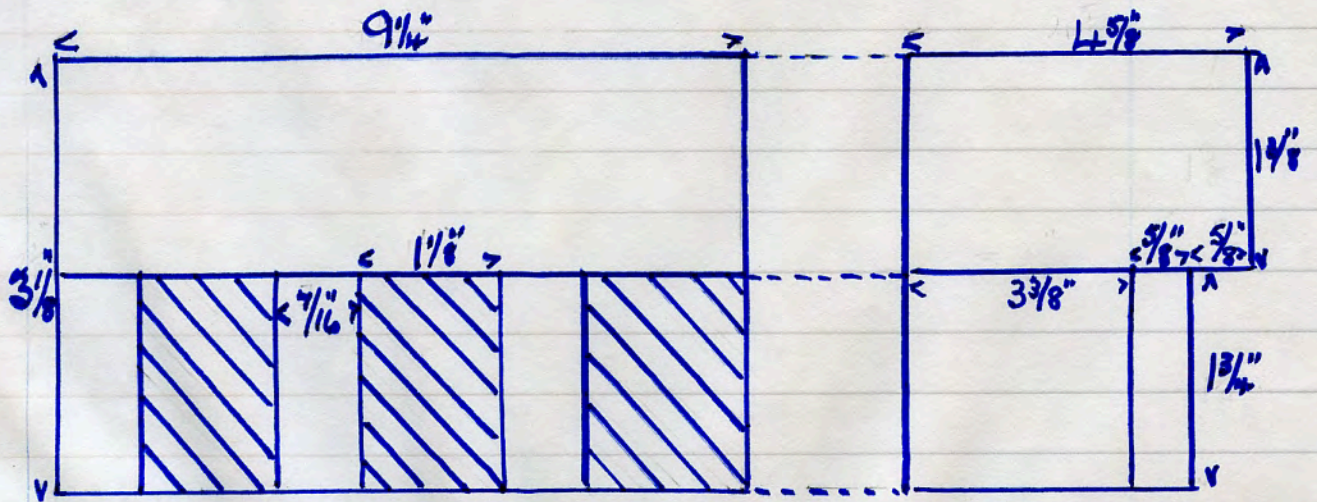

No name. No 96 in Bonfield B-I. lo. bo. Ltd cat. red. 9 lbs.

H422

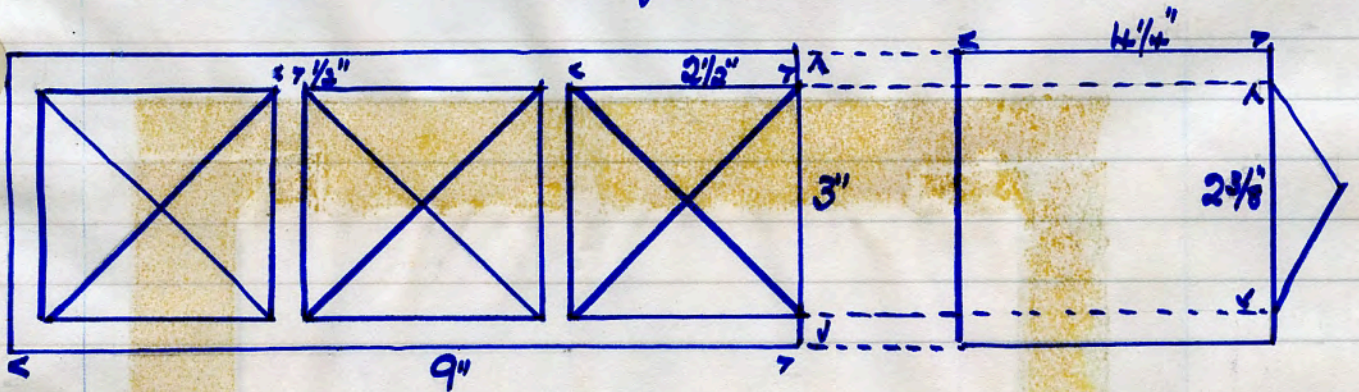

No name. No 84 in Bonfield catalogue. red. 9 lbs.
Accepted Mori dem. site 69. 2. '89 + 17. 2. '89

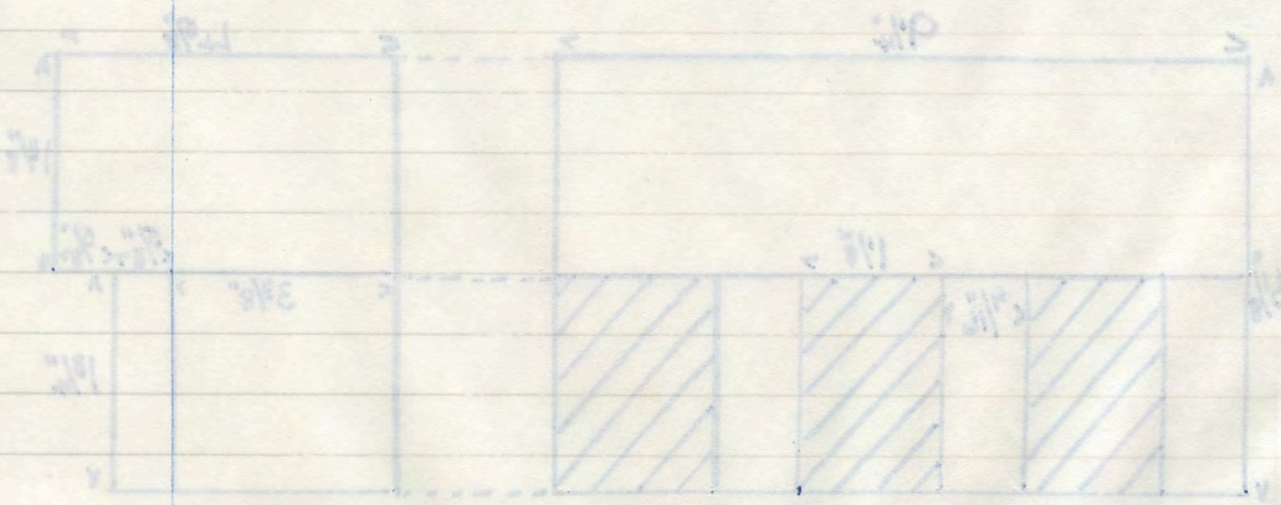

11-21

No name, the photo in the photo is of the photo.

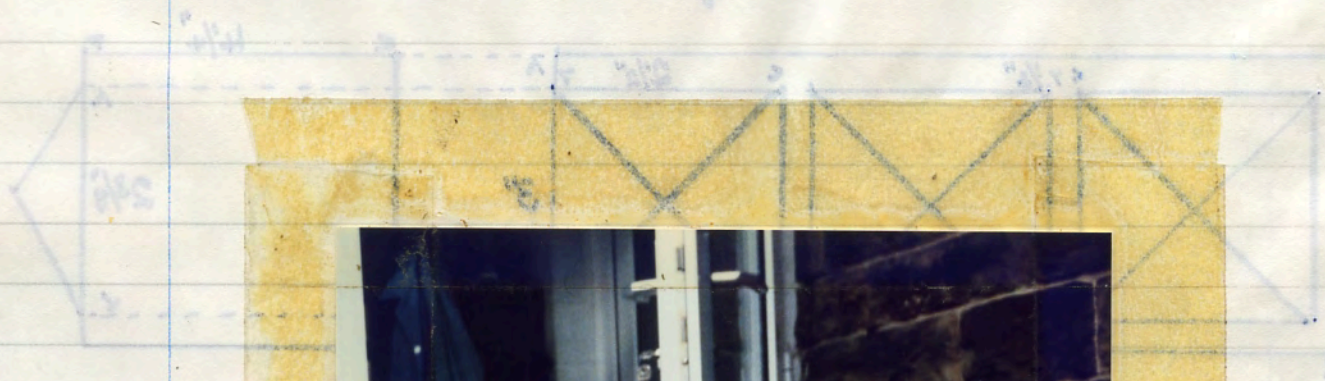

11-21

All P
P.P. 11

No name
Photo



4423.

37 PIA incised
red terra sotto. 23 lbs.
No name
Acc/ton Mori dem. site

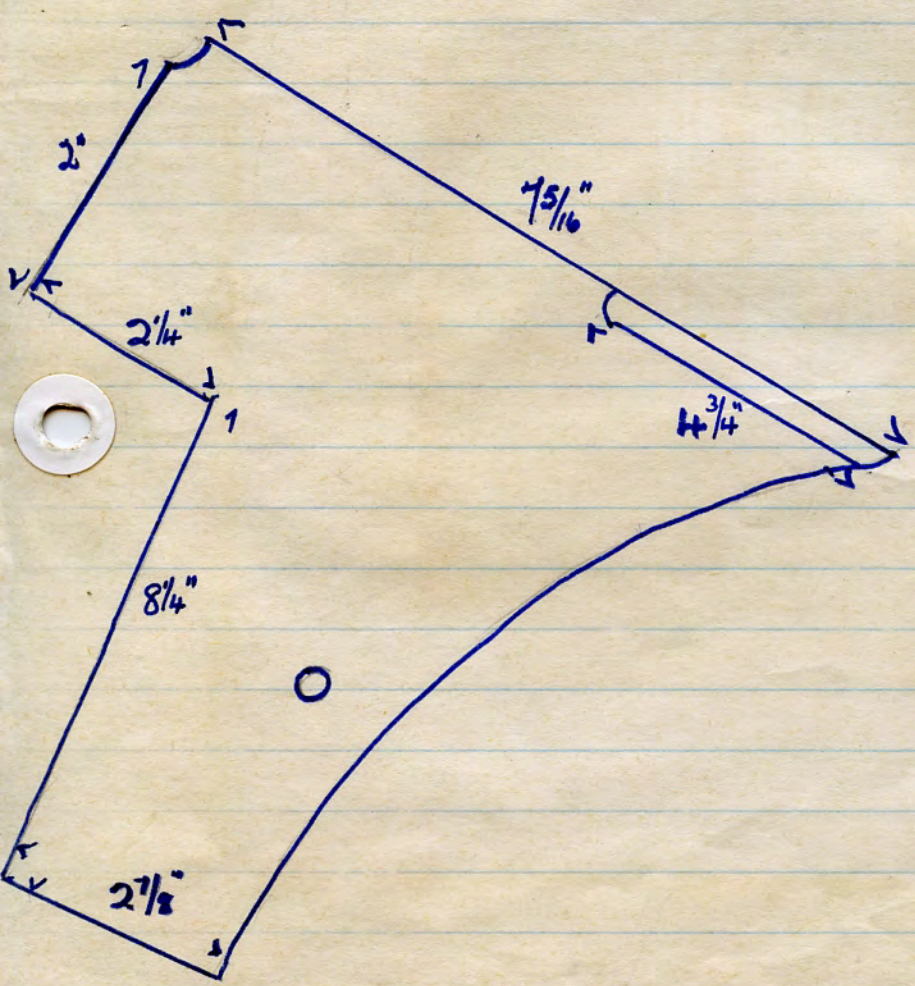
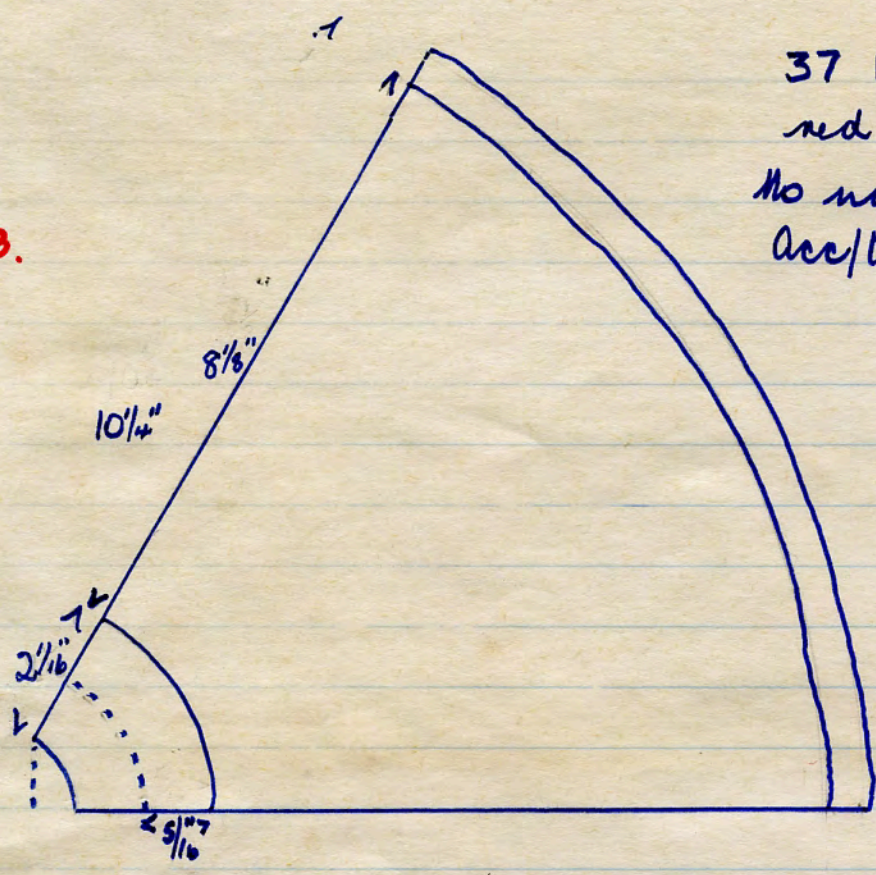

No name. dec. red T.C. string course. 21 lbs.
2 units form pattern: each unit 9" x 6" (back to front) x 6 1/2" deep
Acc/Kon Mori dem. site. each unit 21 lbs

4424



27/2/89

WINIL No 198 (Whinney Hill Plastic Brick Co)
 red, T.C. dec garden edge tile (nope edge) 9 lbs.

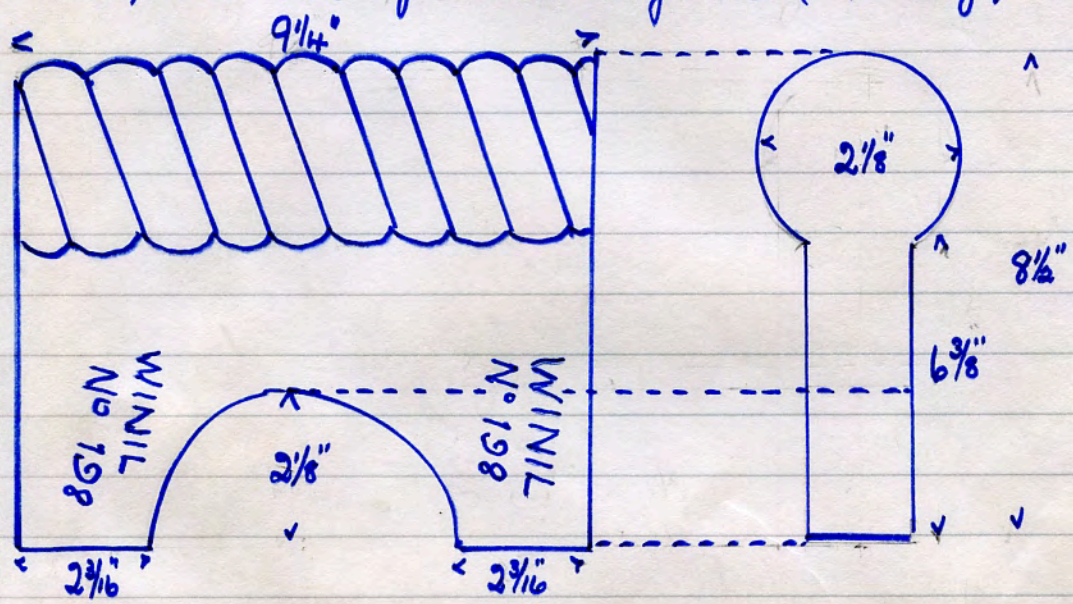

4425

Acc/ton Hosi dem. site

57 Q 14 red T.C. 7 lbs. moulder's mark P
 Acc/ton Mori dem. site

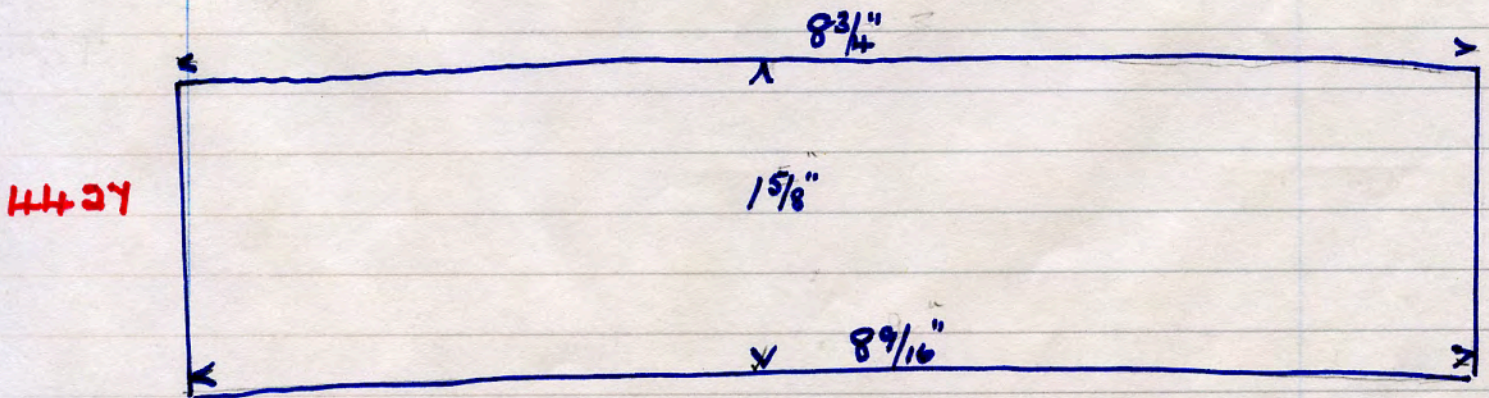
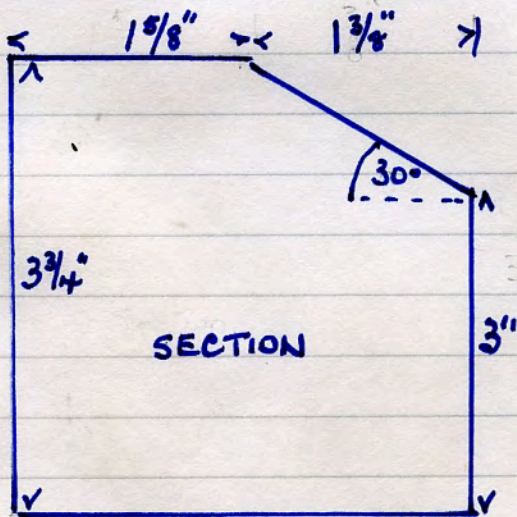
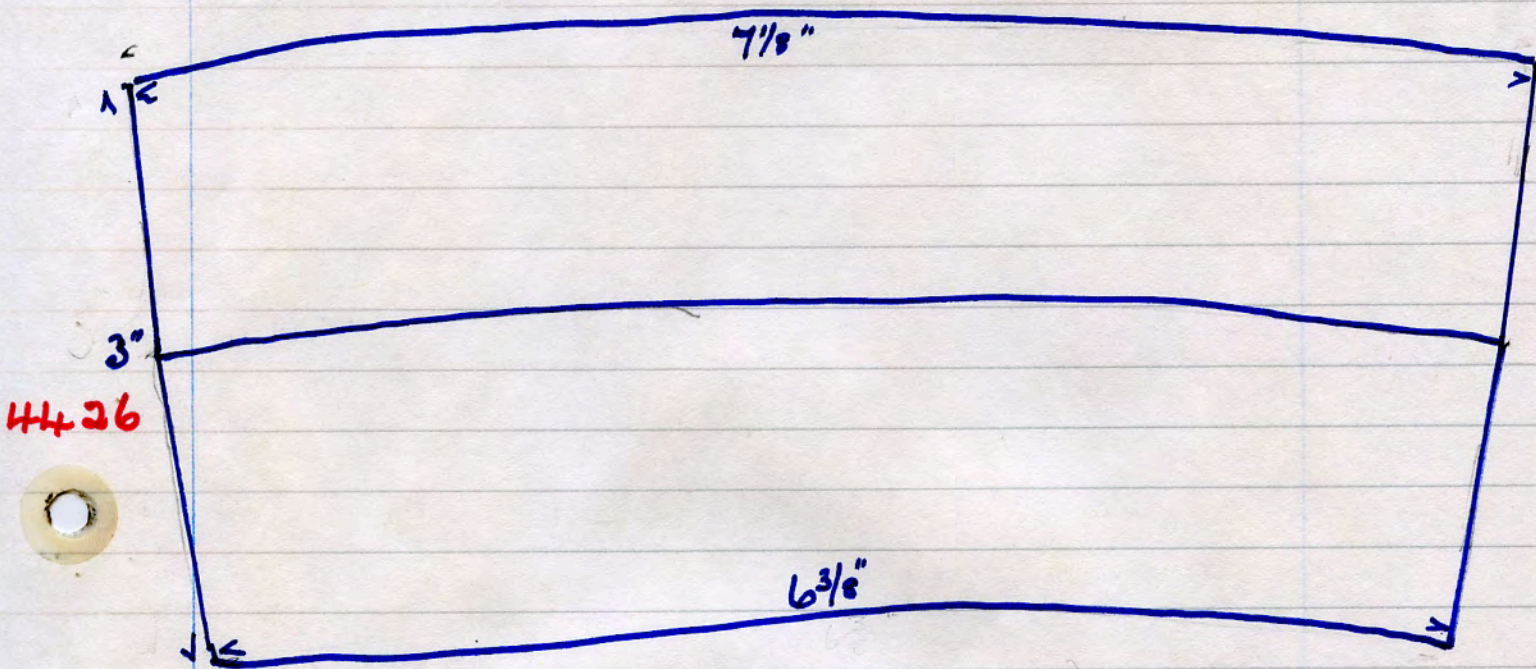

89 Q. red T.C. 5 lbs width 4"
 Acc/ton Mori dem. site.

4428 DCA red T.C. 7 lbs
 23 cm x 9 cm x 5.5 cm
 Acc/ton Mori dem. site

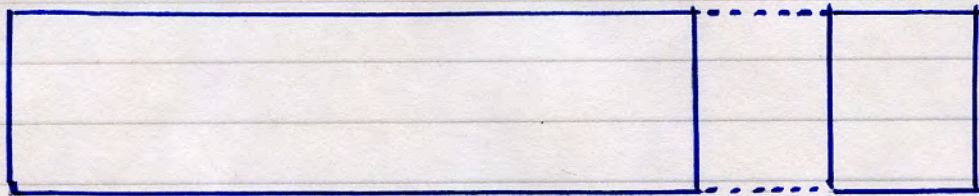

4428

4429 75 K 14 med T.C. 10 lbs
 22 cm x 10.5 cm x 7.5 cm
 Acc/ton Mori dem. site

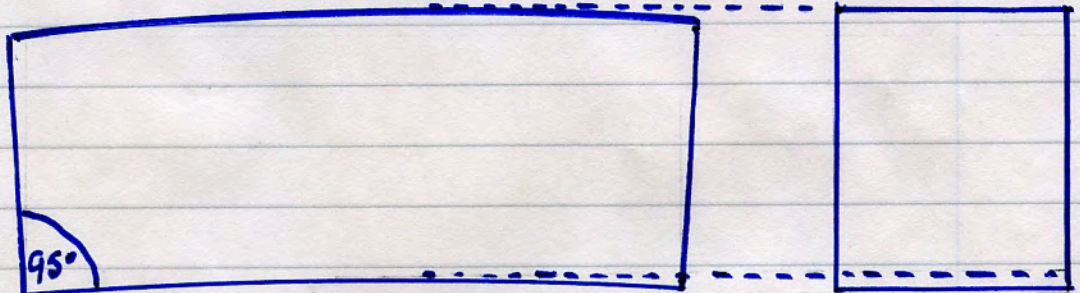

4429

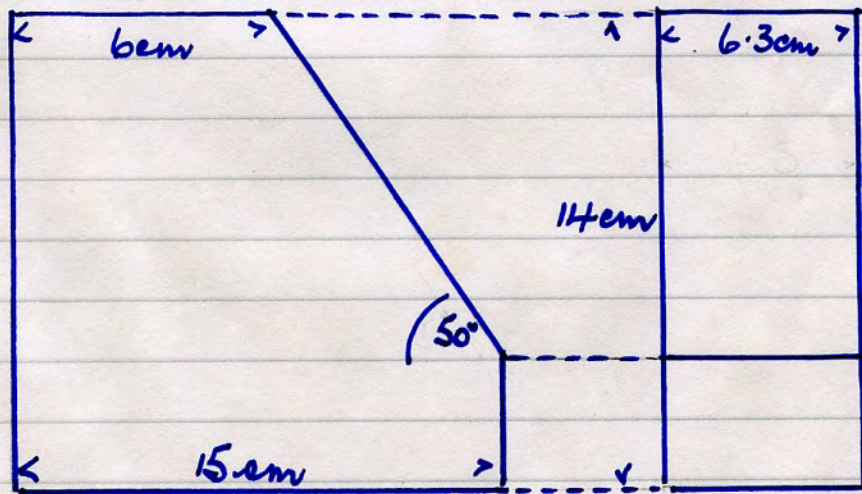

4430

870 VB dark brown 5 lbs
 Acc/ton Mori dem. site

ST 45 red T.C. dog leg.

10 1/2 lbs.

H431

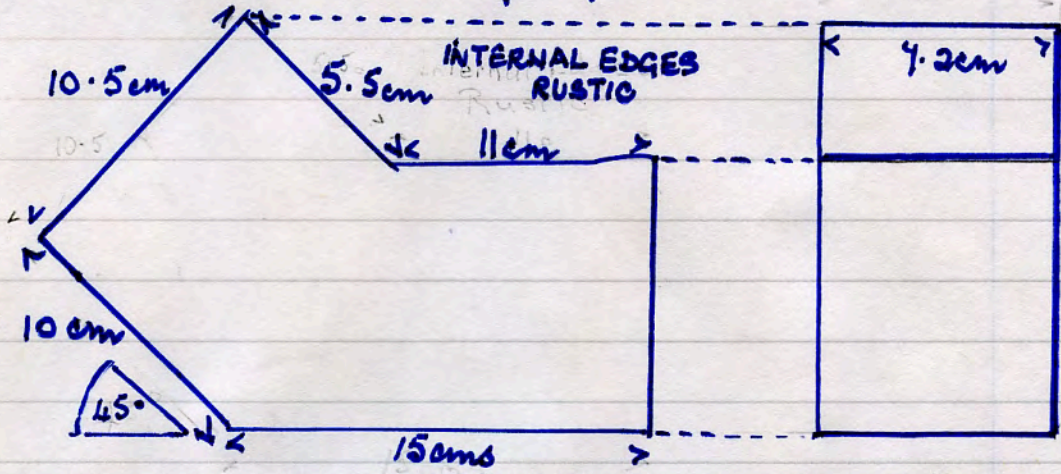

No 61 in Enfield B & T.C. Co Ltd catalogue.

B. red T.C. return 8 lbs

5 3/8" x 5" x 2 7/8"

H432

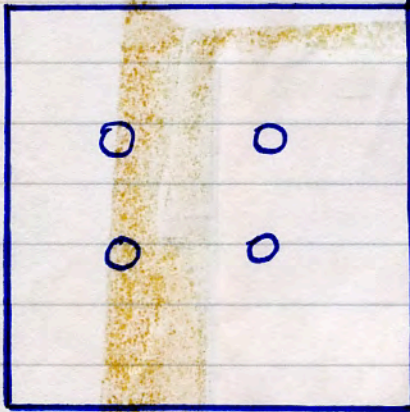

DECORATIVE
EDGE



4 x 5/8" perfs. 1 1/2" deep. B stamped on 1 edge.
Acpton Moss dem. site.

D M. red T.C. floor tile, dimpled surface.

13 lbs 11 3/4" x 5 7/8" x 1 7/8"

Acpton Moss dem. site.

H433.

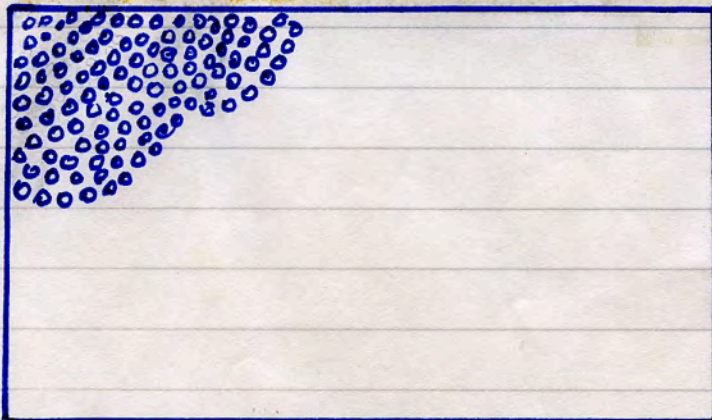

26/2/89

10/12/01

2T + 5 and T.C. cap top



H-11



H-11

H-11

4434

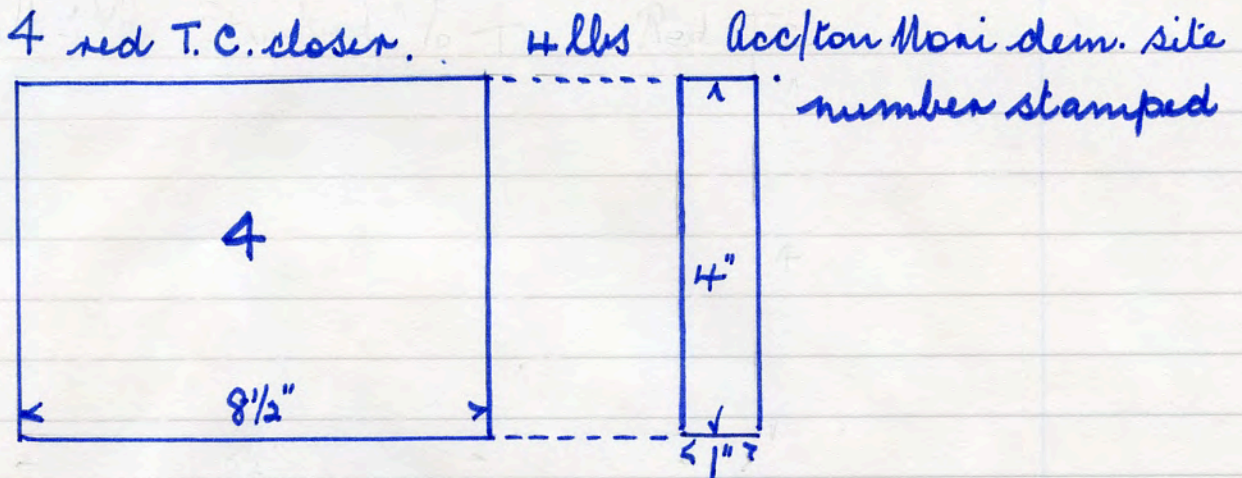

4435

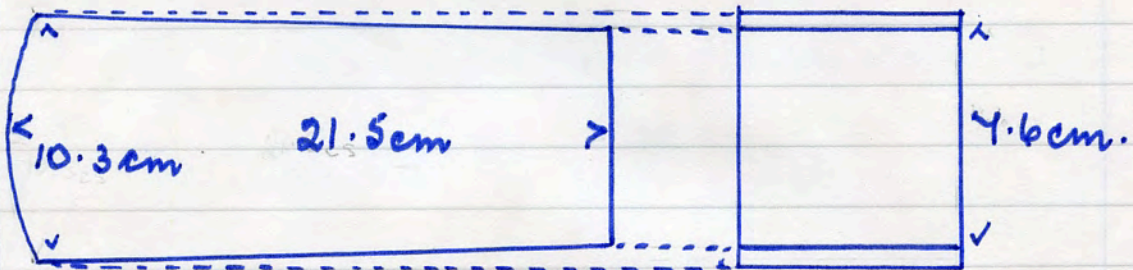

27120 red ganged brk. circular header.
7 lbs number stamped on edge.
Accton Mori dem. site

4436

93 Q 41 red T.C. 12 lbs
similar brk to 3854. They make a right & left
pair. (see opposite). Accton dem site.

4437

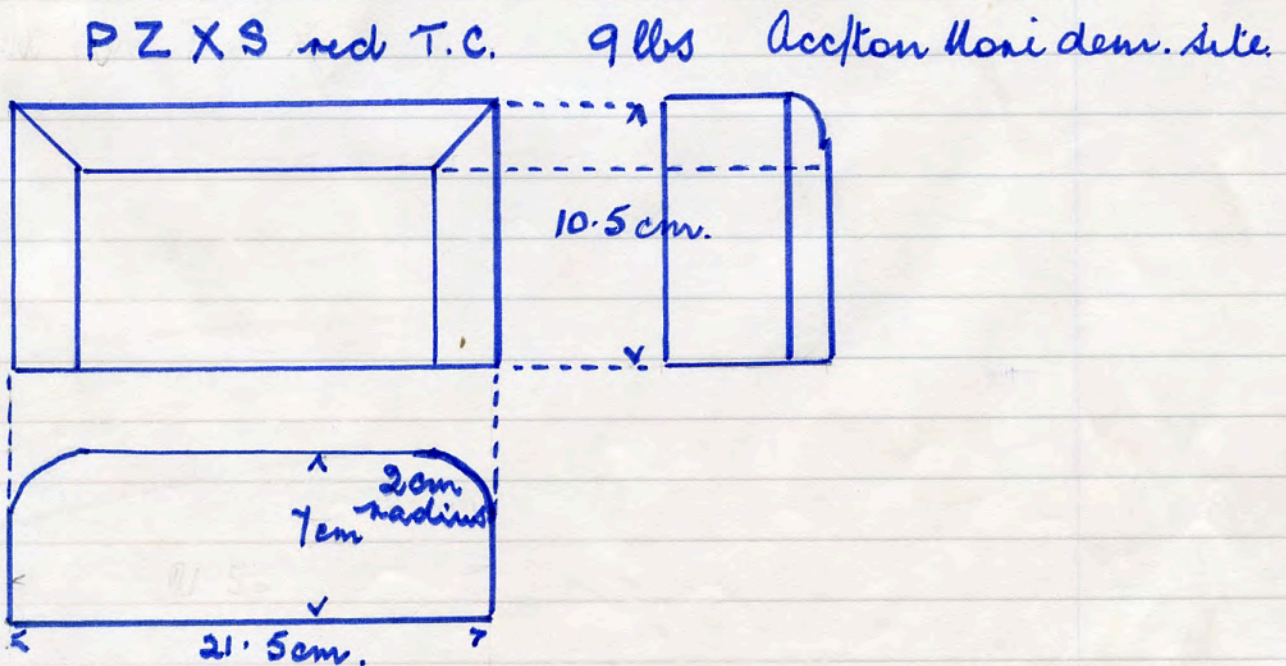

T1L red T.C. closet

11 lbs

4438

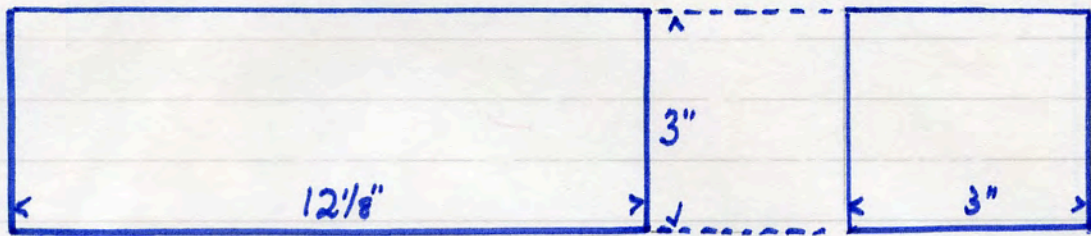

Acception Mori dem. site.

27 7T red T.C. Acception Mori dem. site 9 lbs.

4439

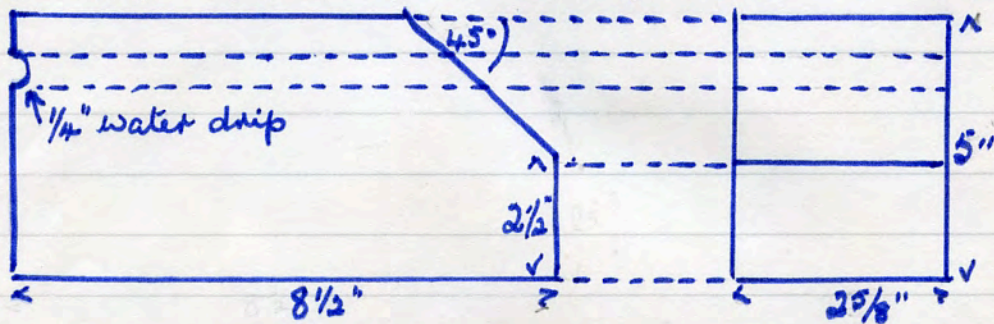

7L red T.C. Acception Mori dem. site

9 lbs.

4440

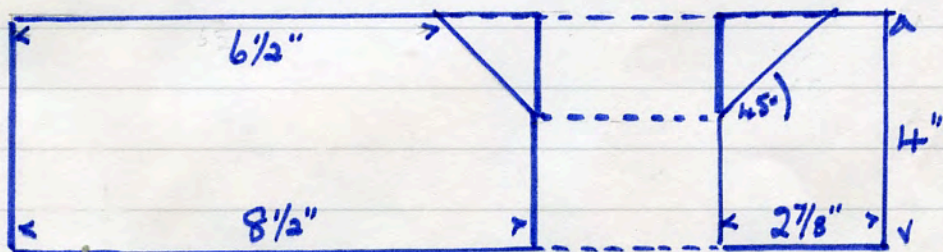

5L 783 VDR red T.C. 21.5cm x 10.2cm x 6.5cm.

9 lbs

4441

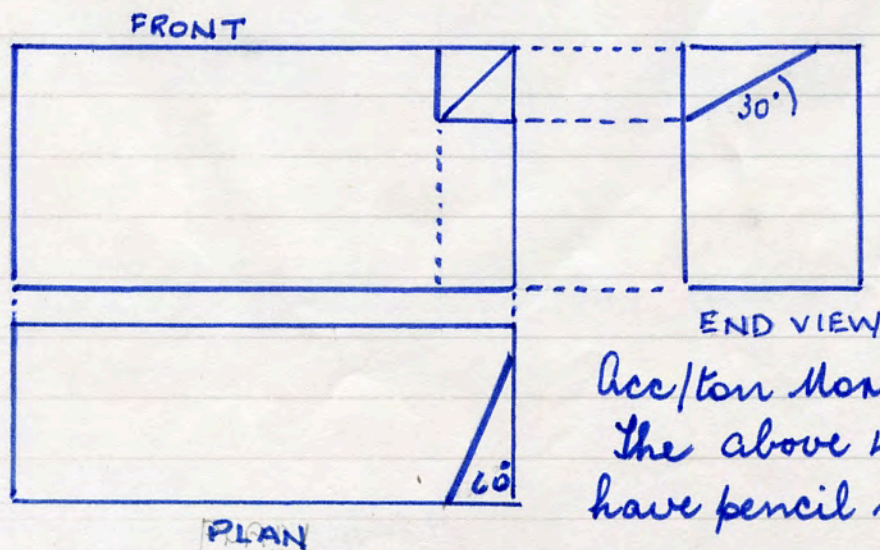

Acception Mori dem. site
The above 4 bricks all
have pencil mould arrisses.

L red T.C. 21.5cm x 10cm x 6.6cm. 9 lbs.

4442

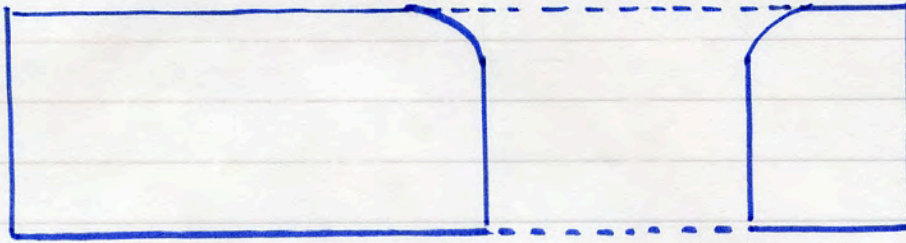

13 3-0 red T.C gauged brk for arch 9 lbs

4443

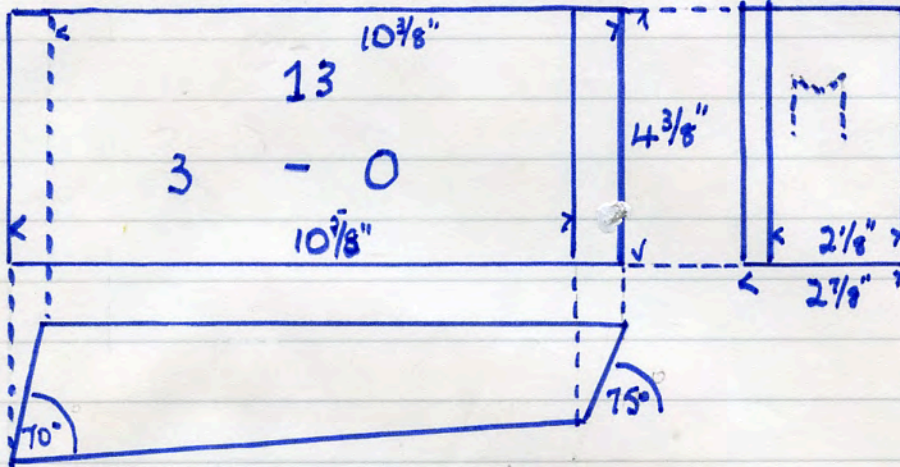

Acc/ion Moni dem. site

9 3-0 red T.C gauged brk for arch 9 lbs

4444

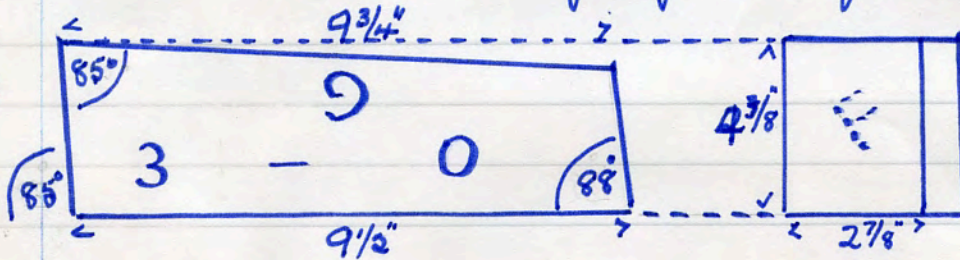

S 2 4-1/2 red T.C gauged brk for arch 14 lbs

4445

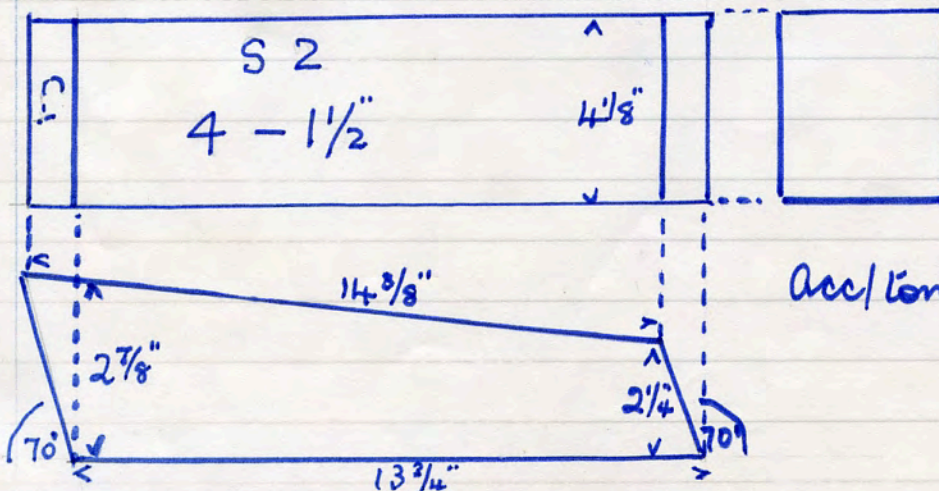

Acc/ion Moni dem. site

S 14 4 x 1 1/2 red T.C gauged bolt for arch. 14 lbs.

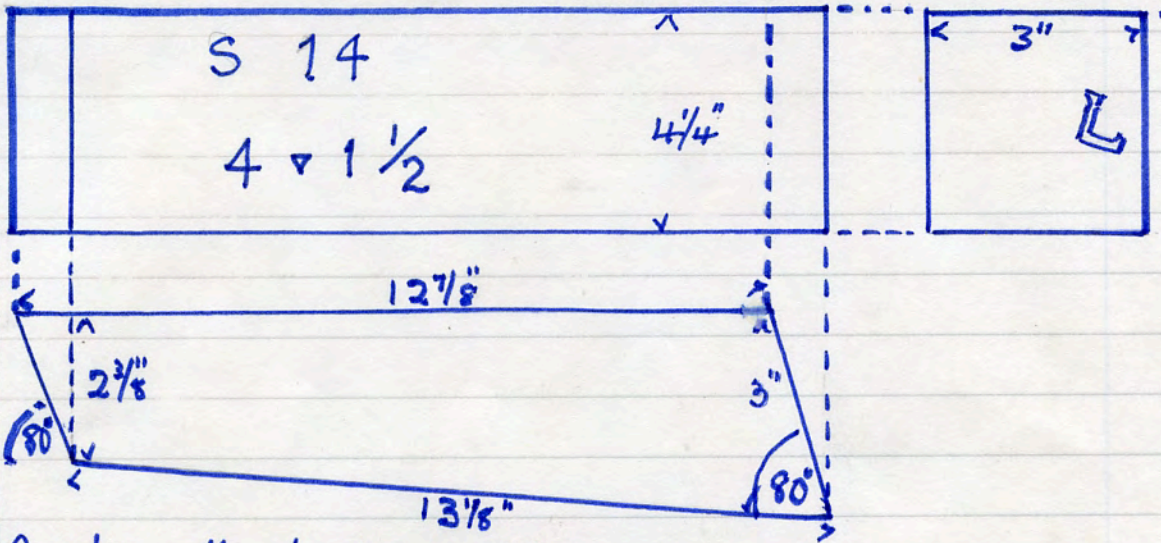

4446

Accepton Mori dem. site

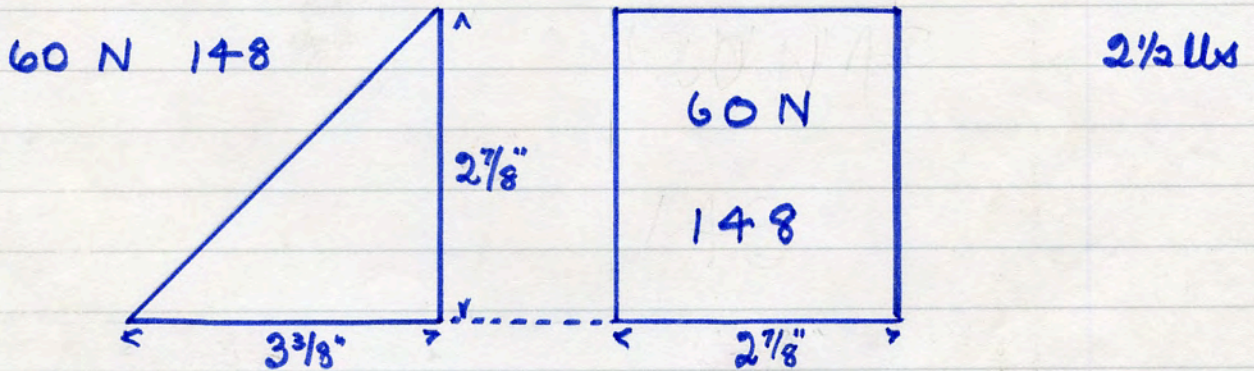

4447

red T.C triangular closer. Accepton Mori dem. site

4448

61 P 18 no name red T.C

21 lbs.

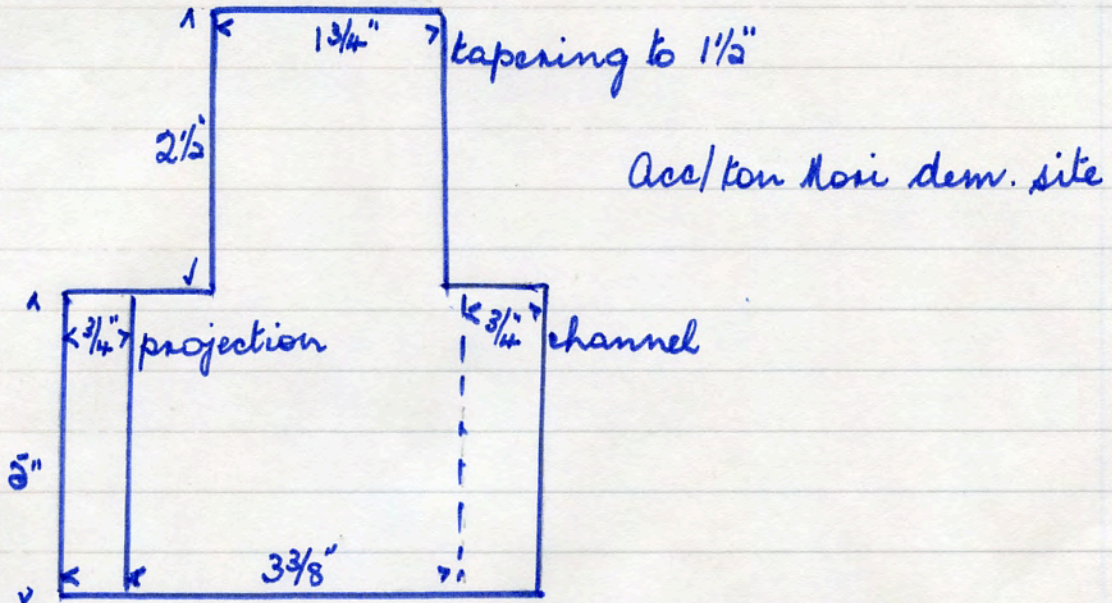

Acc/ton Nois dem. site

++++8

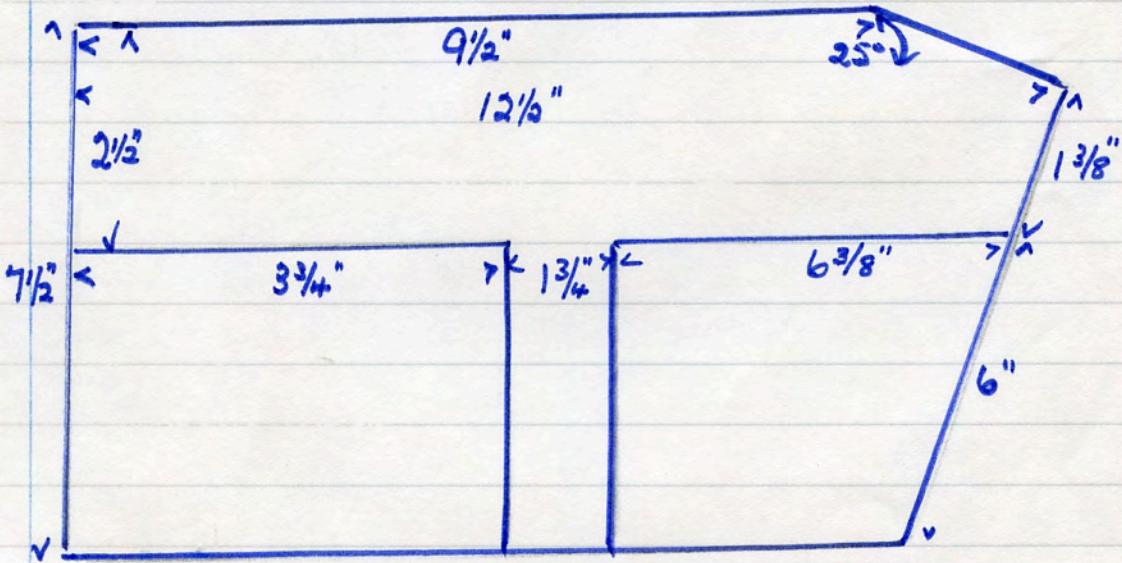

17 OT red T.C.

10 lbs.

Acc/ton Mori dem. site

H4449

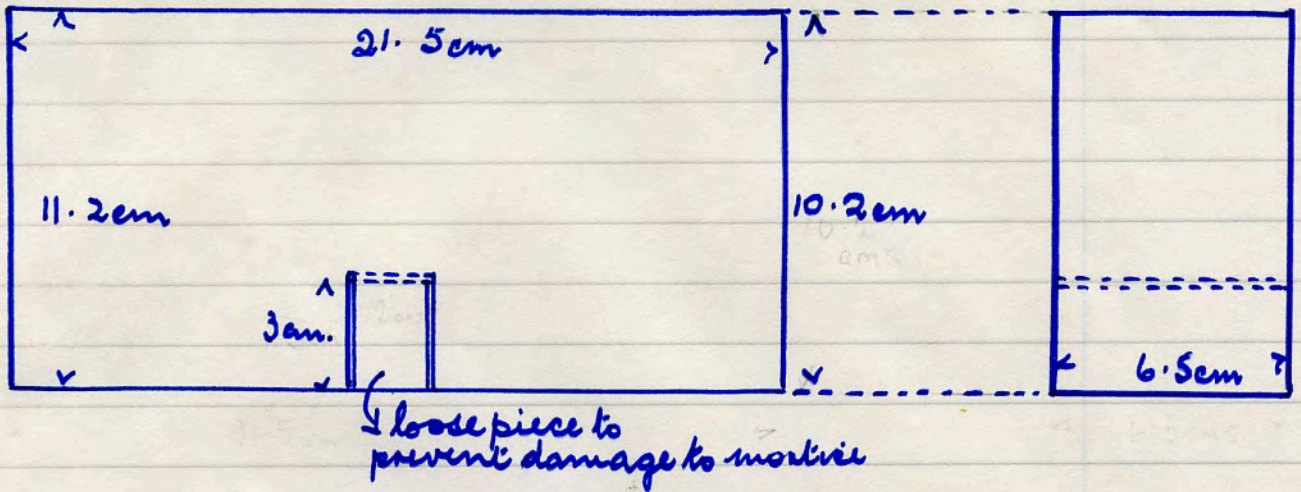

No name. no number. red T.C

7 lbs

Acc/ton Mori dem. site

H4450

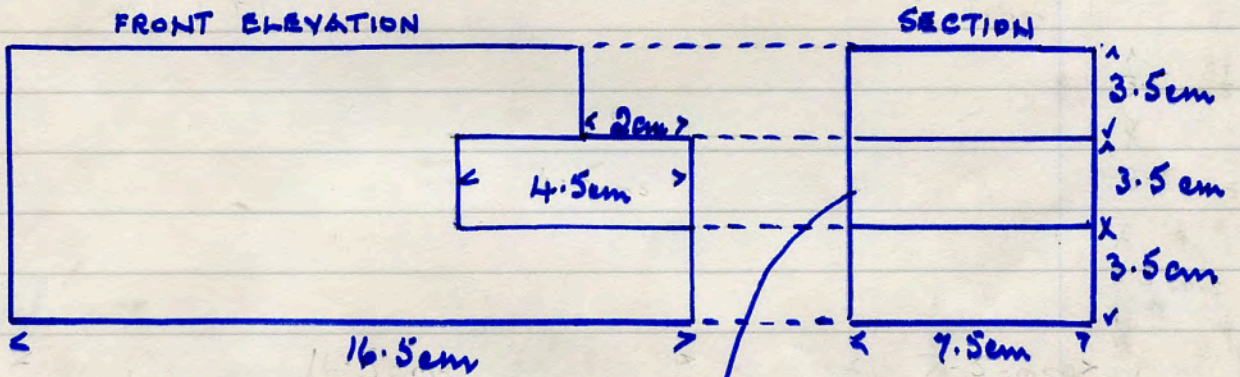

23131 A double nosed wall sapping, rustic finish

8 lbs.

H4451

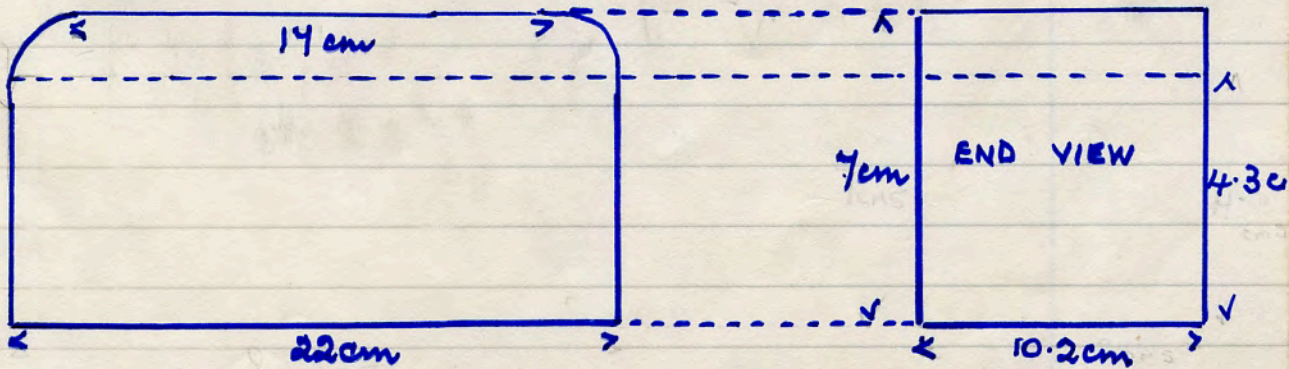

Acc/ton Mori dem. site.

232 1A red. drag finish

7 lbs

4452

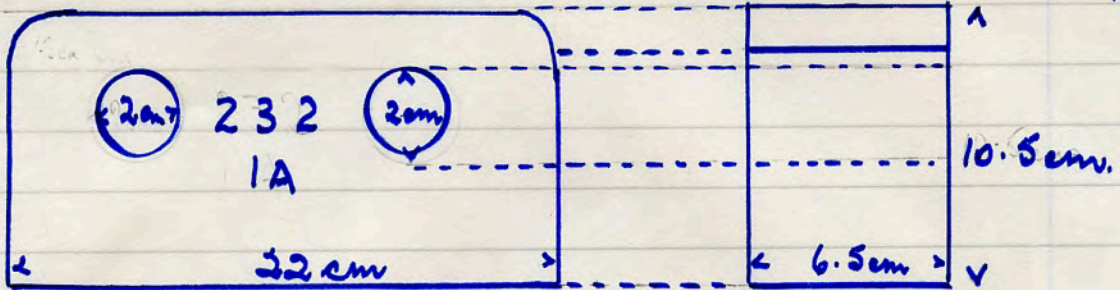

Acc/ten Mori dem. site

4453

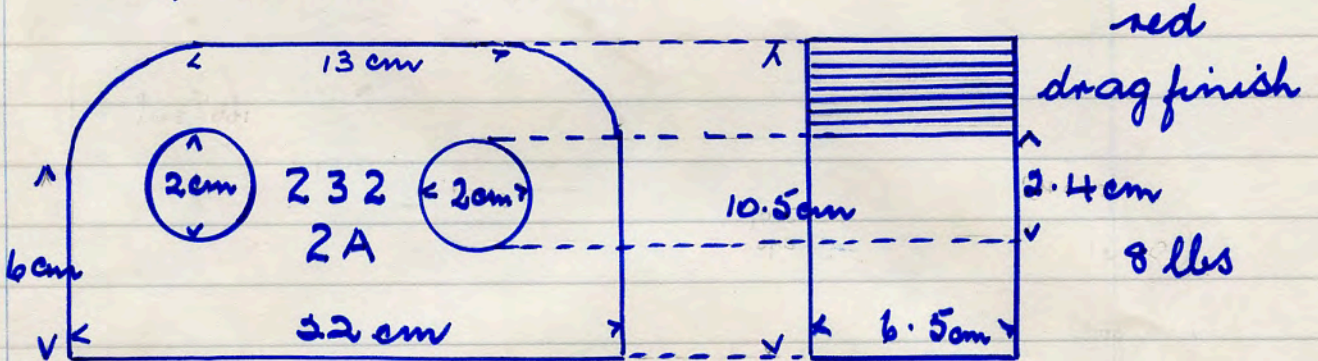

4454

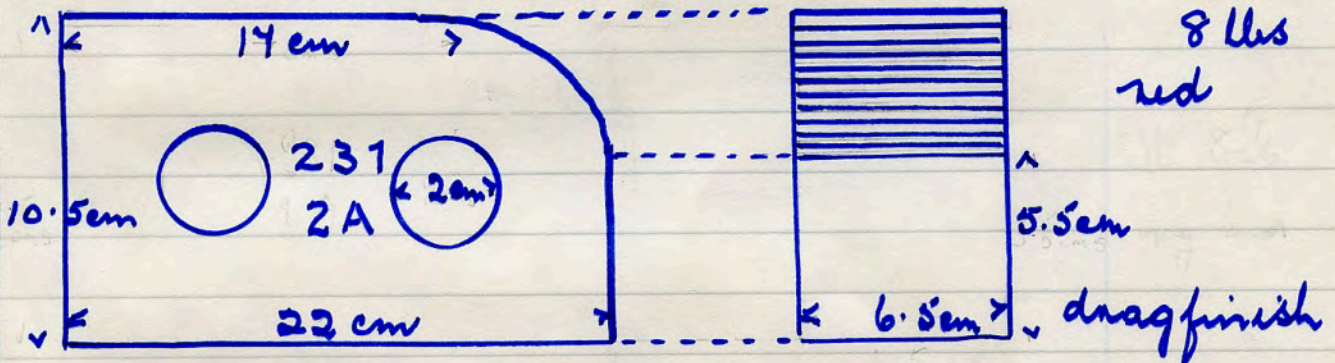

Acc/ten Mori dem. site

231 01LA red. nosed 1 end only

9 lbs

4455

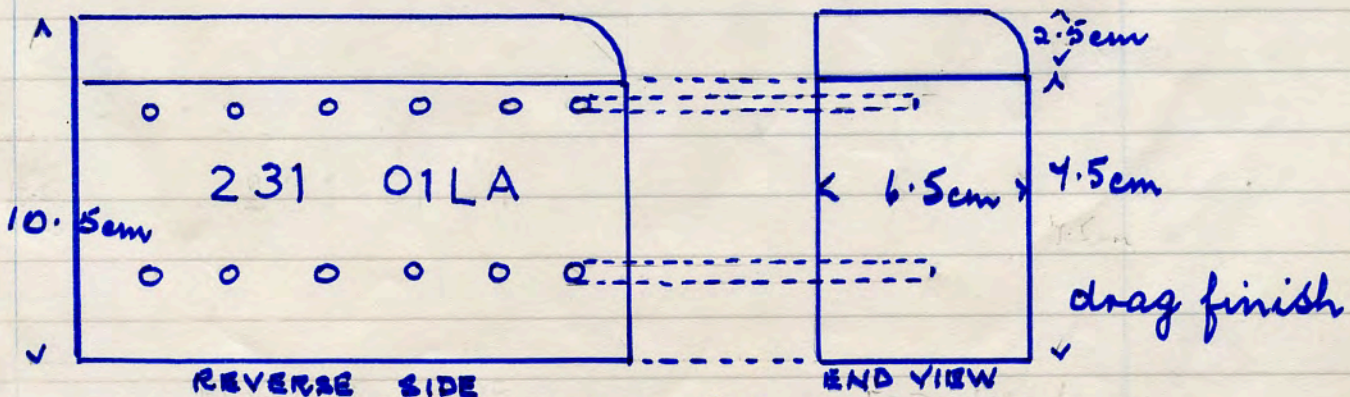

showing 12 x .5 cm diam. holes for fixing.
Acc/ten Mori dem. site

2321 SA . wall capping return. drag finish.

4456

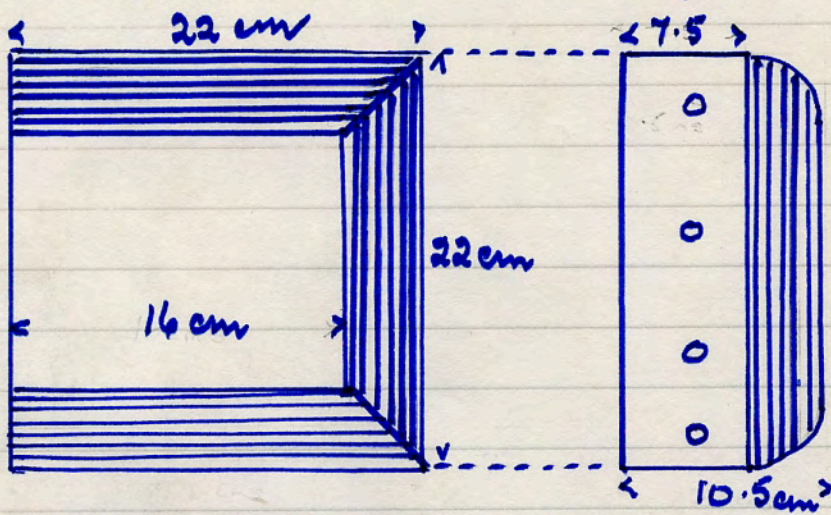

red. 22 lbs

4 x .5cm diam. holes.

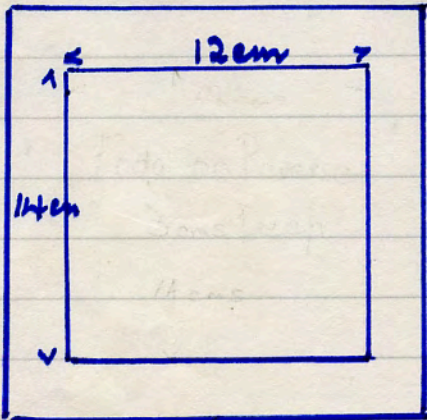

frog on reverse
3 cm deep
Ac/lon Nori dem. site

61 P 13. no name red T.C.

14 lbs.

Acc/ton Mori dem. site

channel

projection

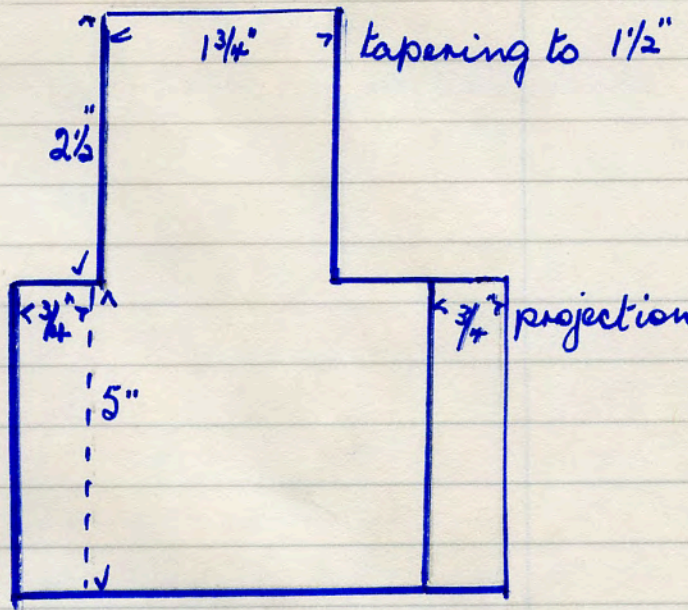

4457

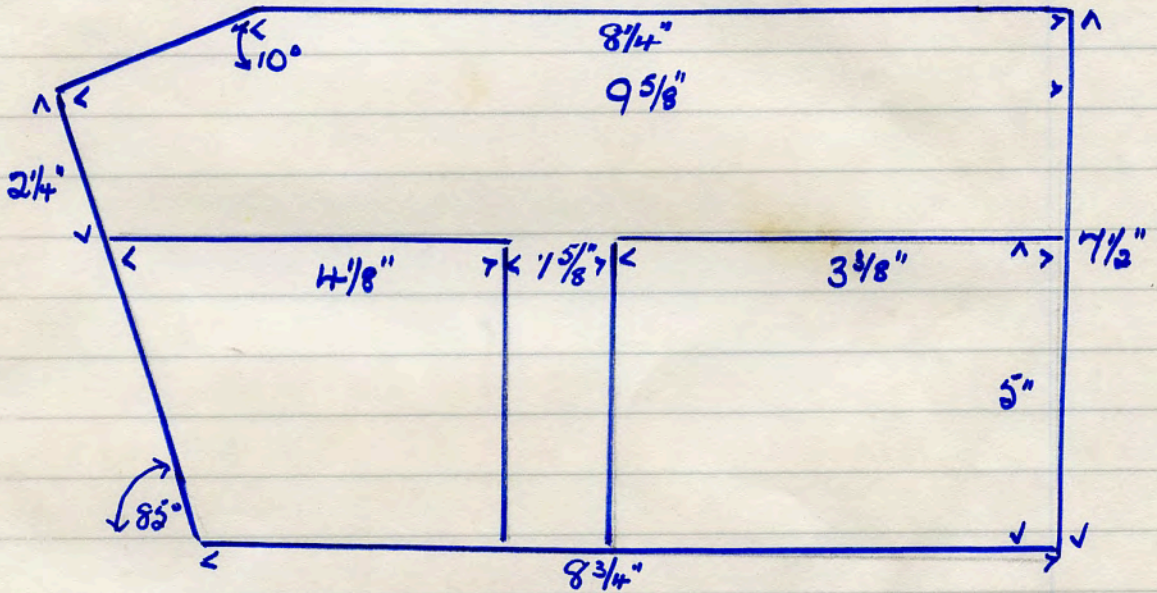

No number. red. sand faced wall or pier facing brick

4458

8 lbs

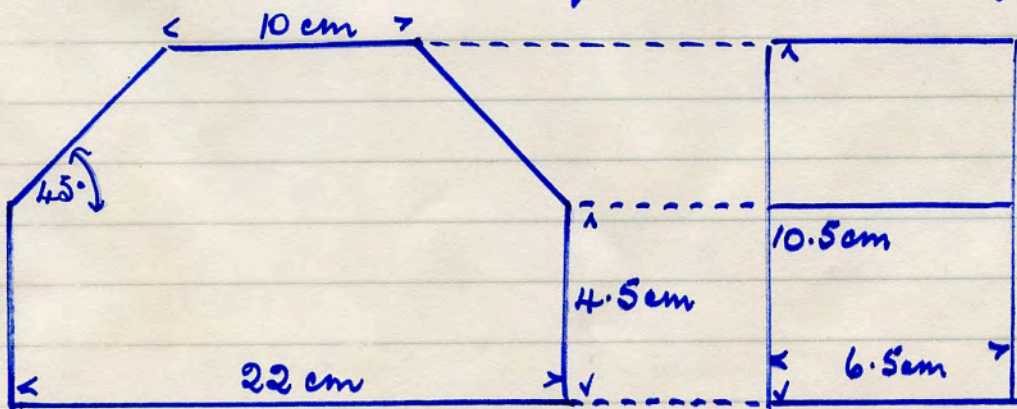

Acc/ton Mori dem. site

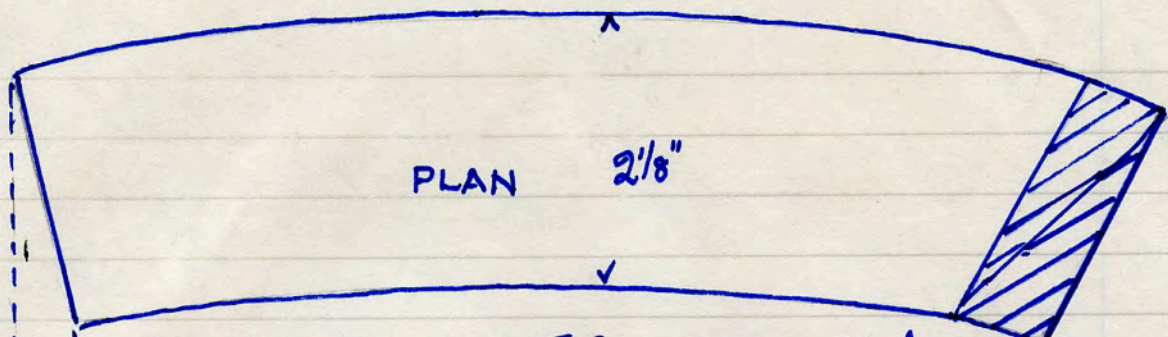

27 G 96 red T.C. use not known. 12 lbs.

4459

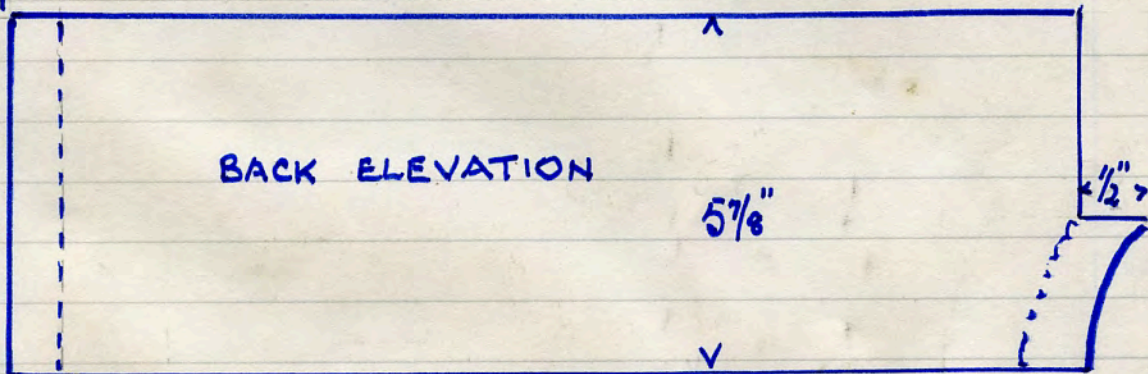
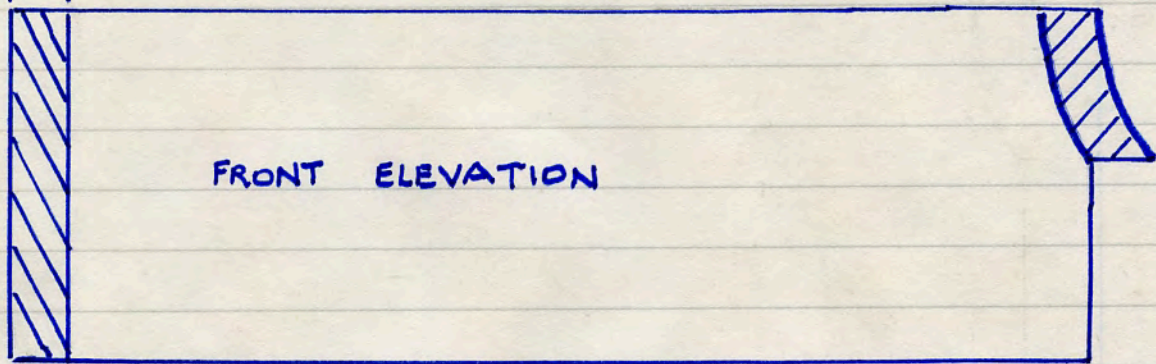

27 G 56 red T.C. use not known

7 lbs.

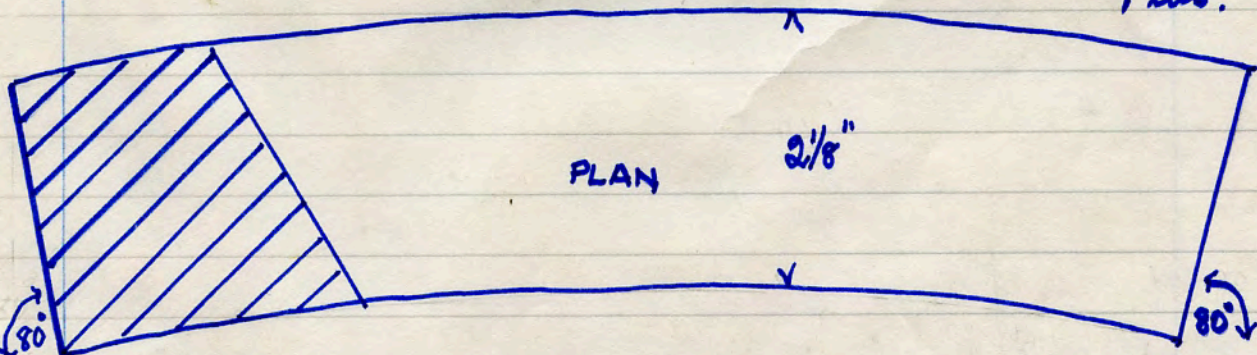

4460

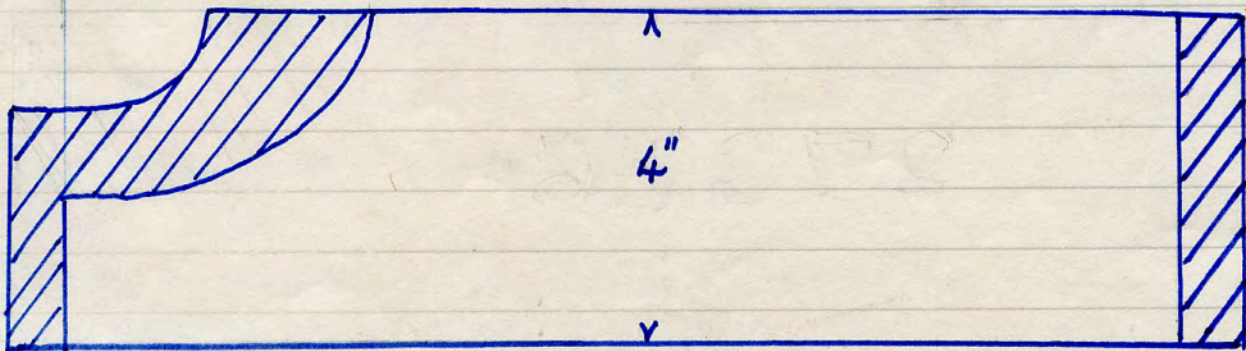

4461

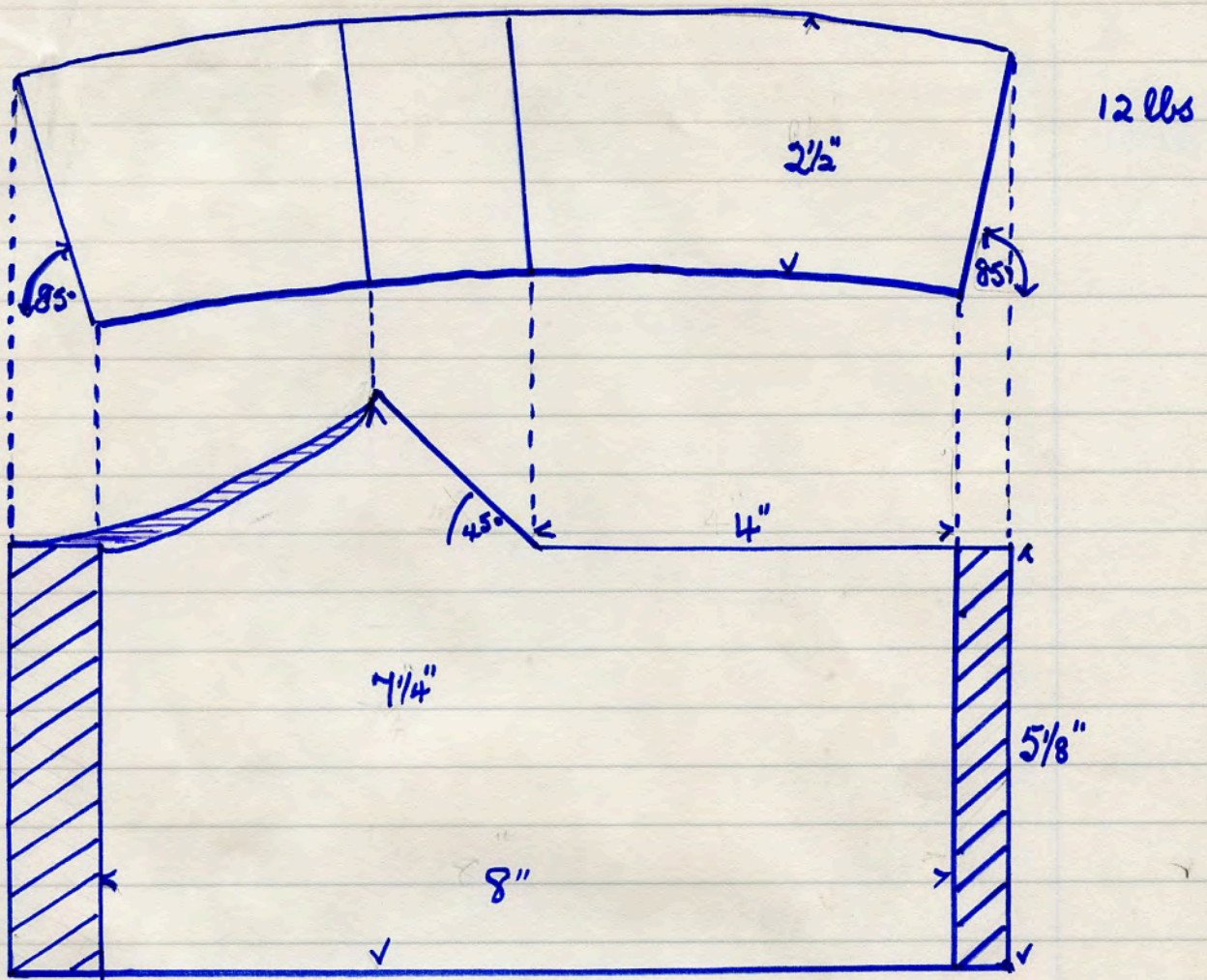

27 G 124 red T.C use not known. no on reverse

4462

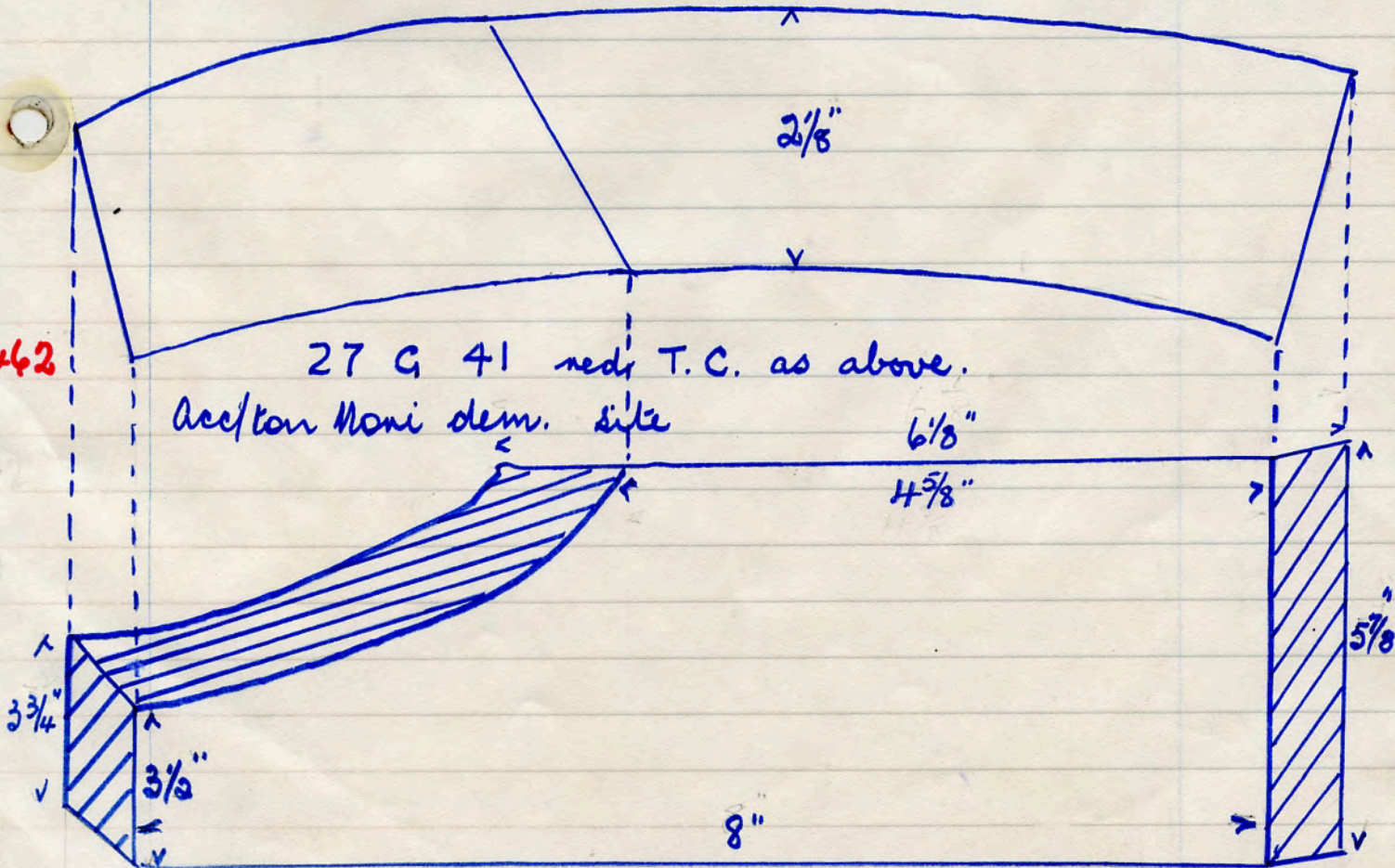

POLN red T.C return plain edge paver

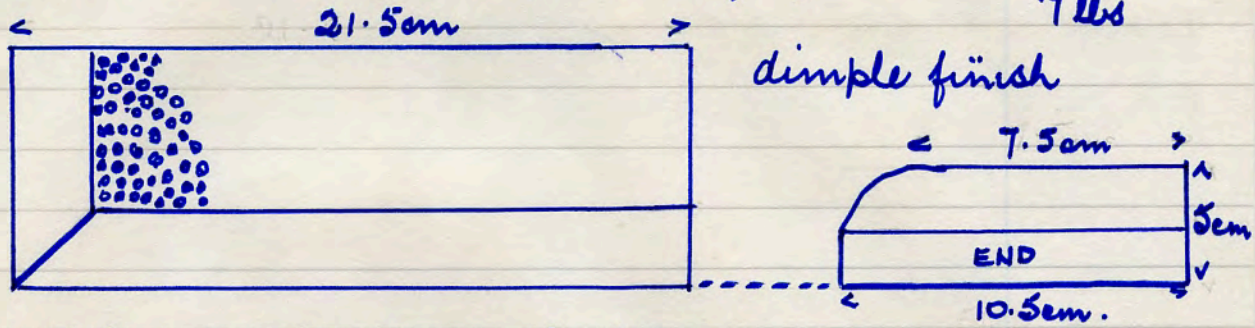

4463

POYRN red T.C return plain edge paver

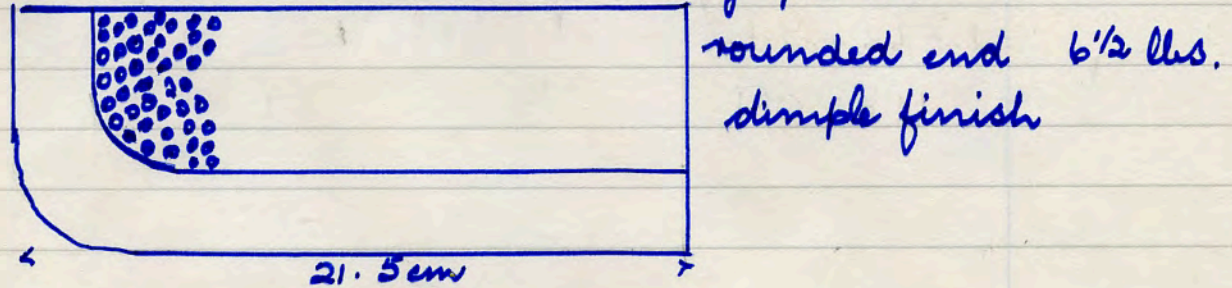

4464

PL11N red T.C paver, rebated for fixing
dimple finish.

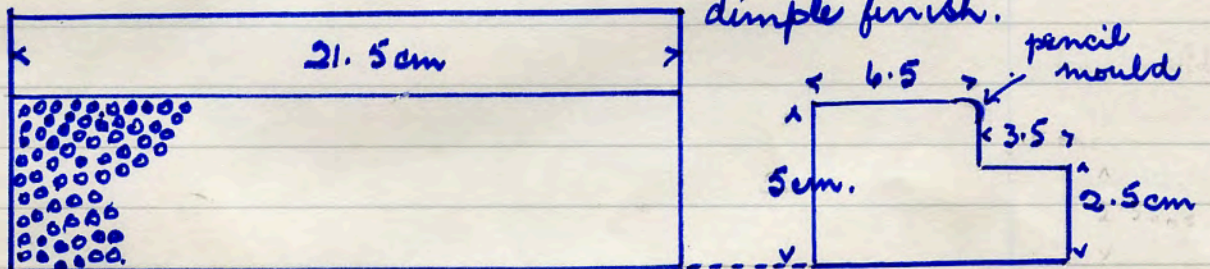

4465

PL66N red T.C mitred return, in situ

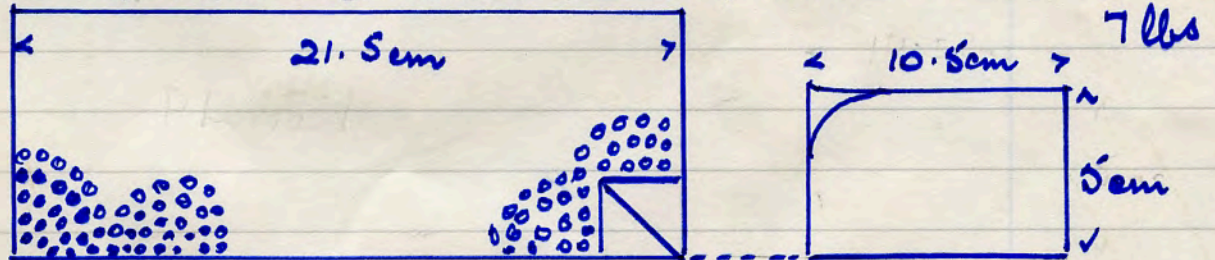

4466

PL65N red T.C as above, but opposite hand

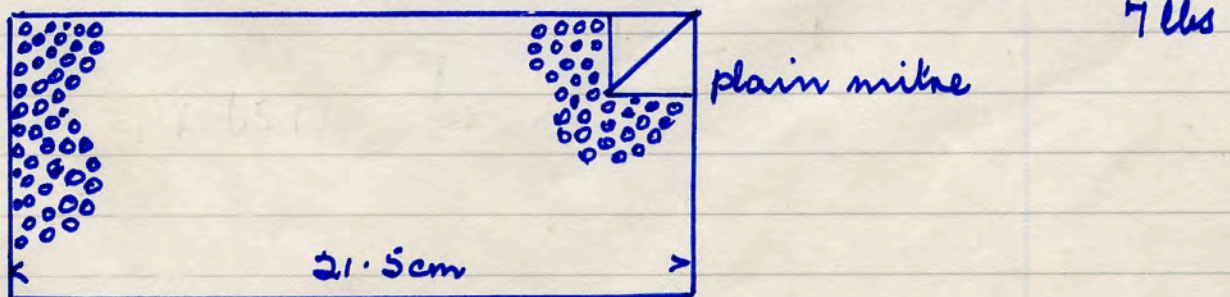

4467

All above - Acc/ton Maxi dem. site

175 AXN red T.C paver. dimple finish 9 lbs

4468

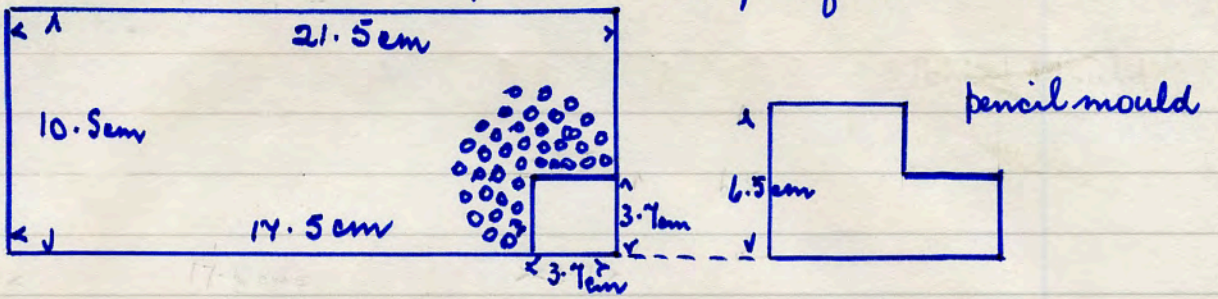

175 ZAN red T.C paver dimple finish 9 lbs

4469

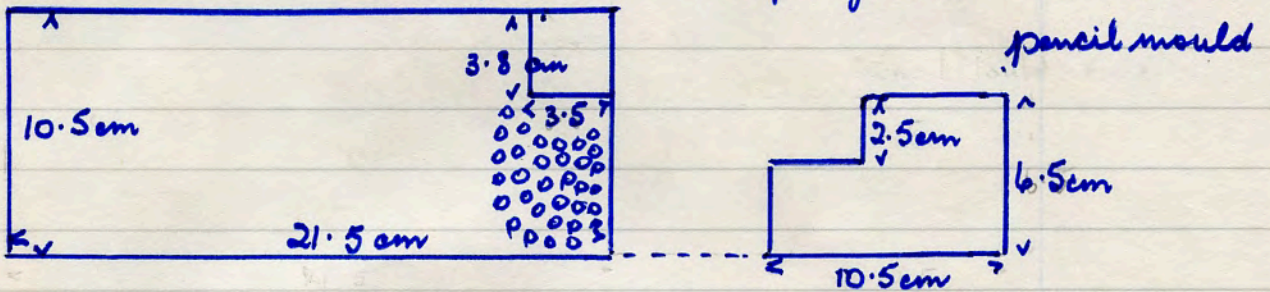

POD N5 red T.C paver. pencil mould 8 lbs.

100

4470

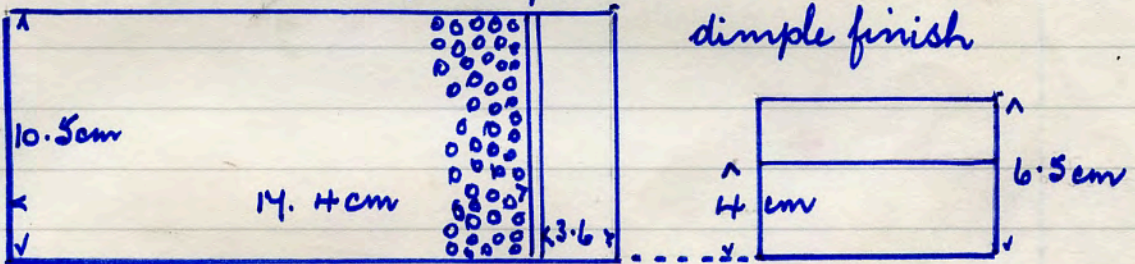

279 58 red T.C 5 lbs.

use not known.

Acc/ten Mori dem. site

4471

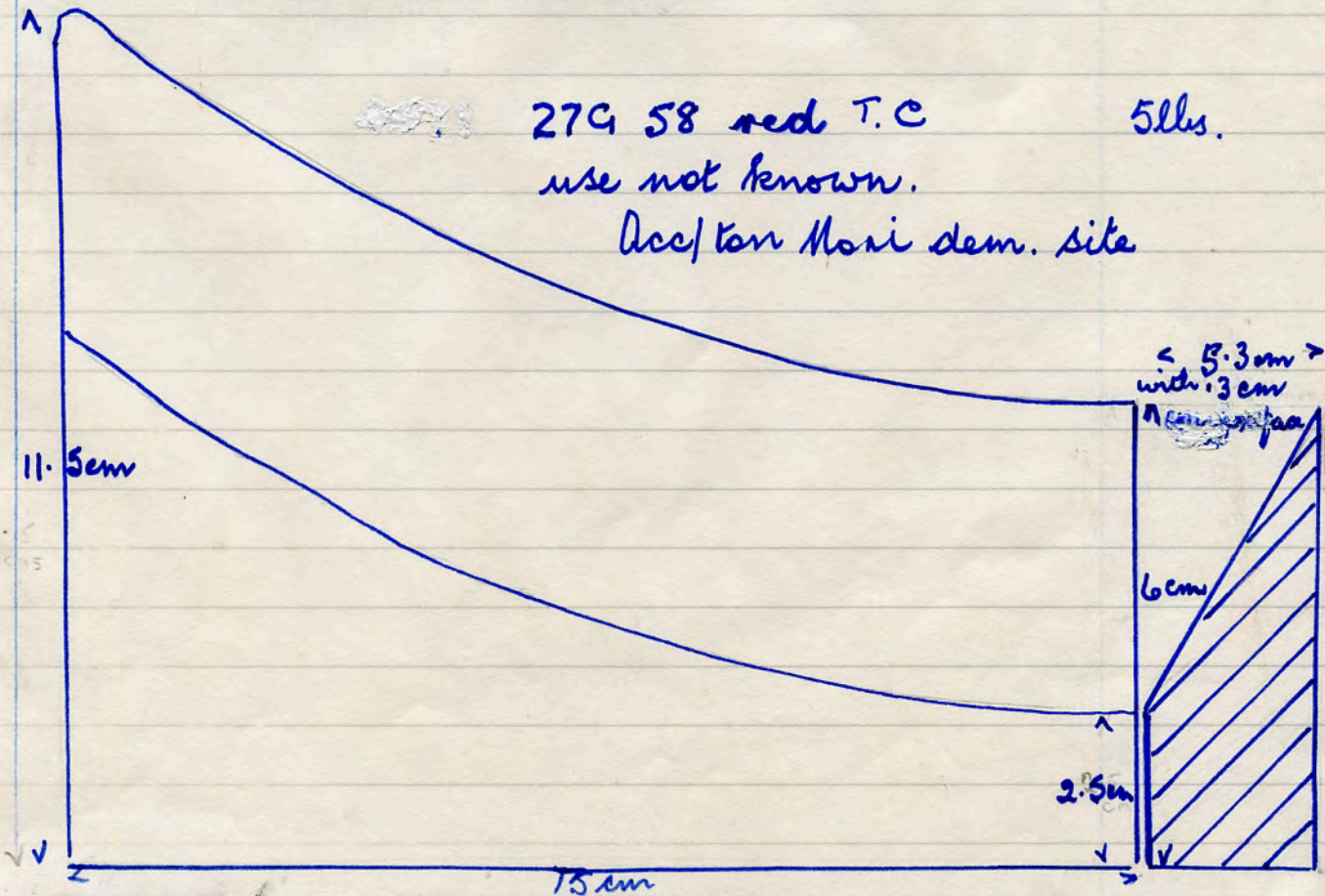

27 G 126 red T.C. use unknown

5 lbs

4472

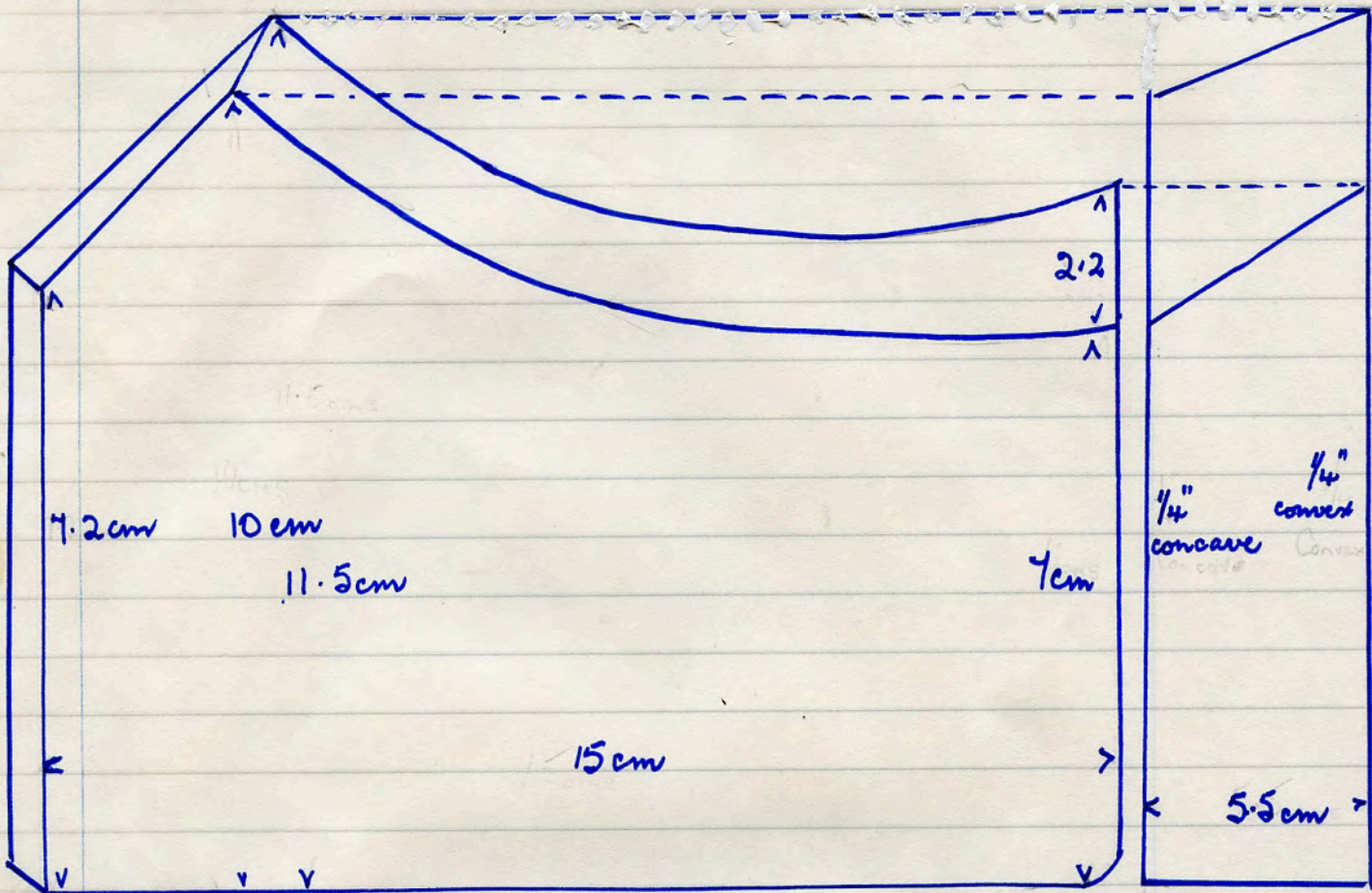

Acc/ton Mori dem. site

PZ9 red T.C

3 lbs

4473

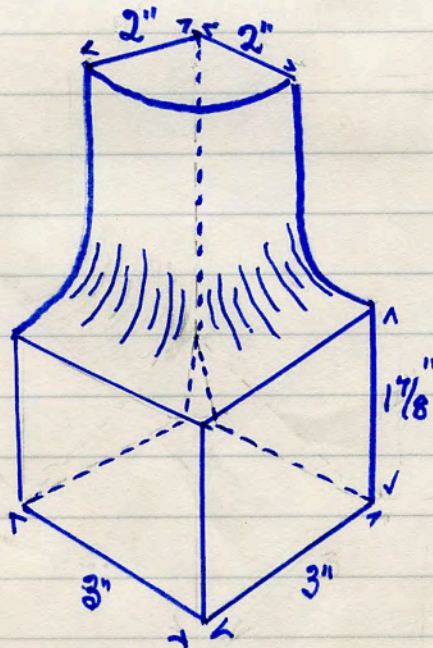

τ

6 1/4"

∇

Acc/ton Mori dem. site.

269 TB

red T.C. Acc/ton Mori dem. site

13 lbs.

4474

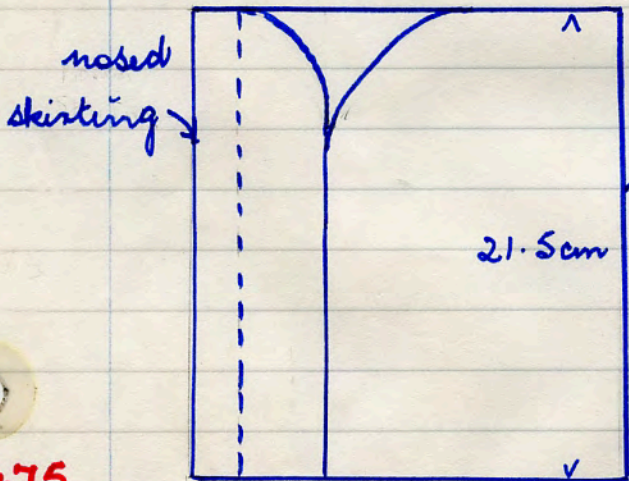
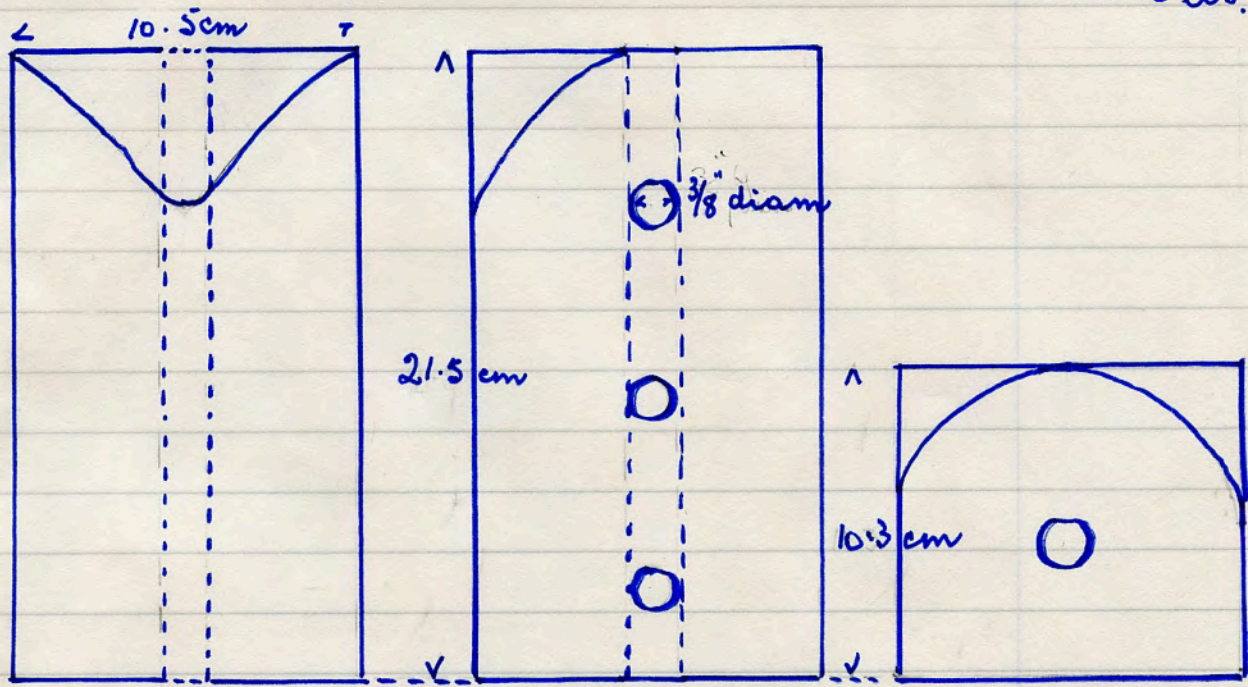

PNXR red T.C skirting corner
 straight + square skirting.

14 lbs

Acc/ton Mori dem. site

4475

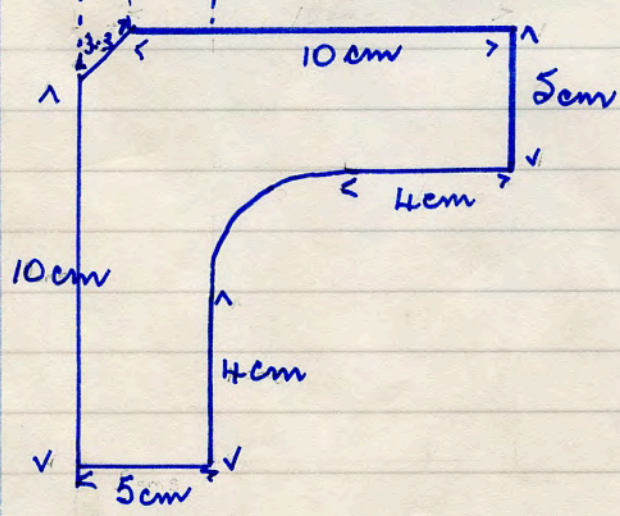

4476

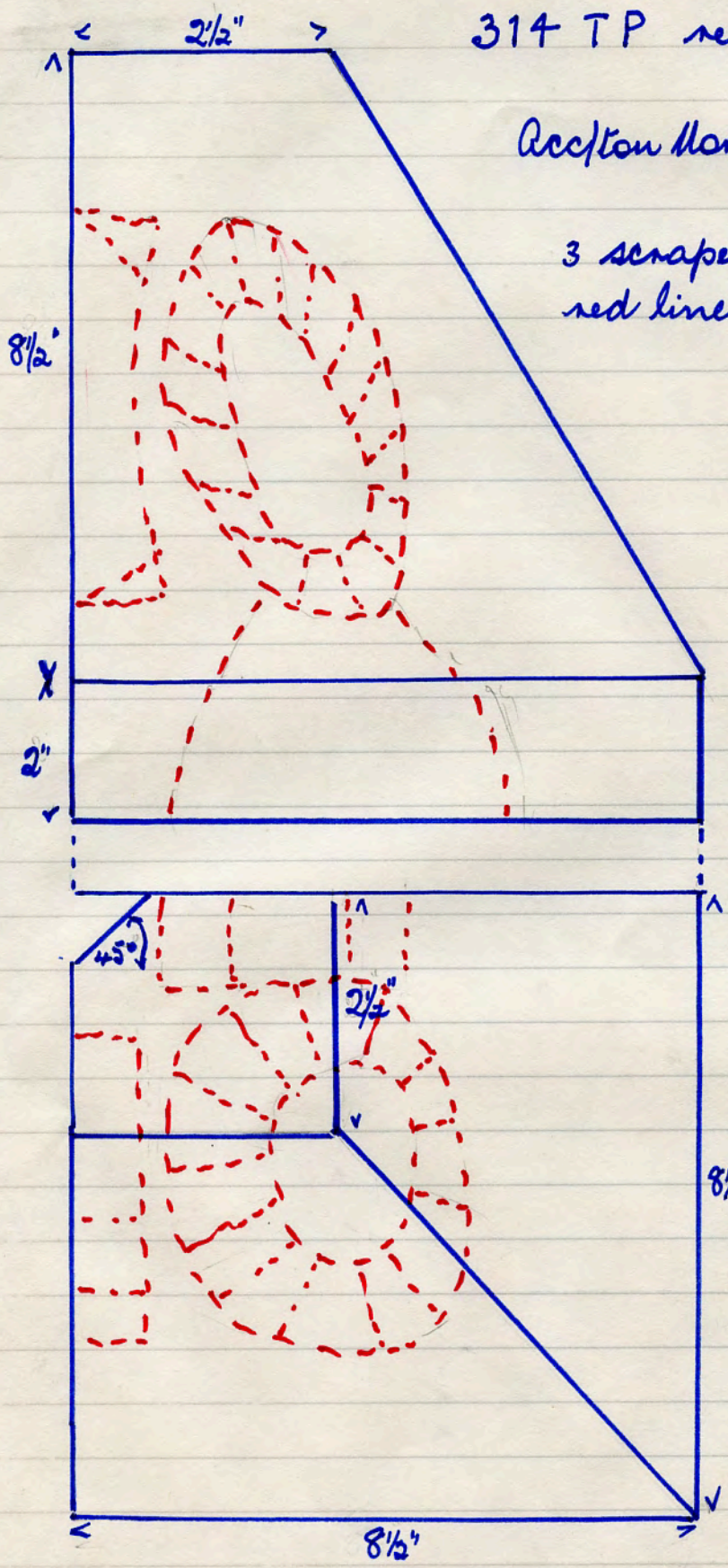

314 TP red T.C corner dummy
28 lbs.

Acc/ton floor dem. site

3 scraped cavities shown by
red lines

61 P 25 red T.C. moulder's mark J1

11 lbs

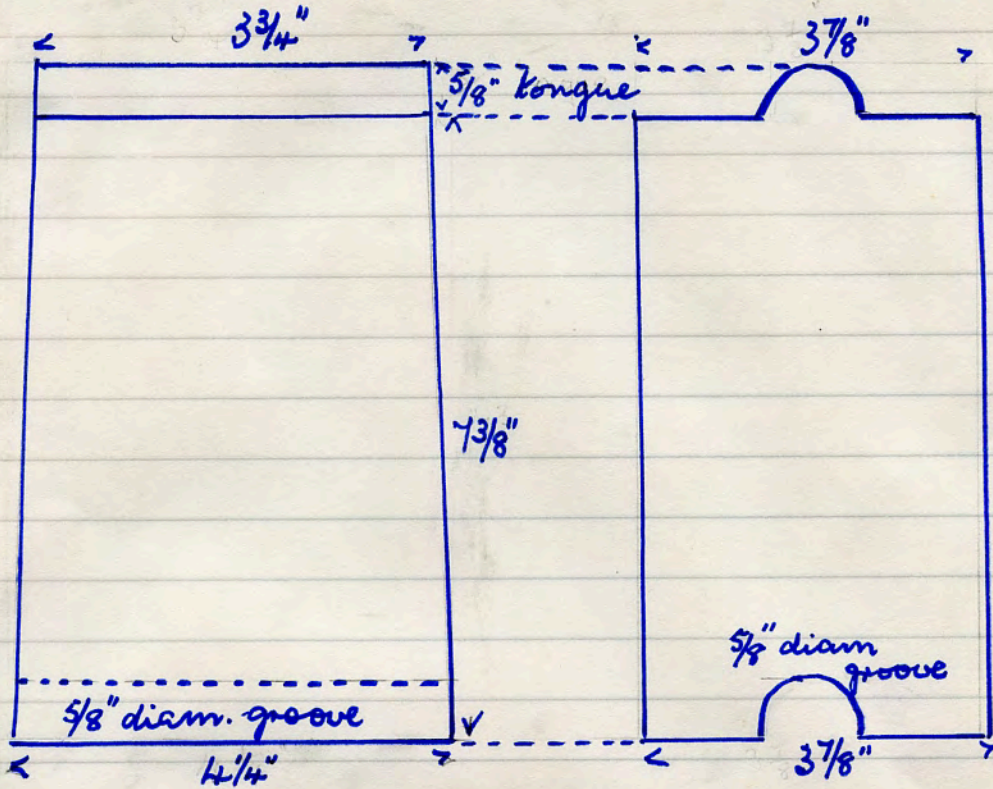

Acc/ton Hori dem. site.

4477

No name. No number. boundary wall of Acc/ton Hori dem. site

Red T.C wall capping from length $11\frac{1}{2}$ " 35lbs

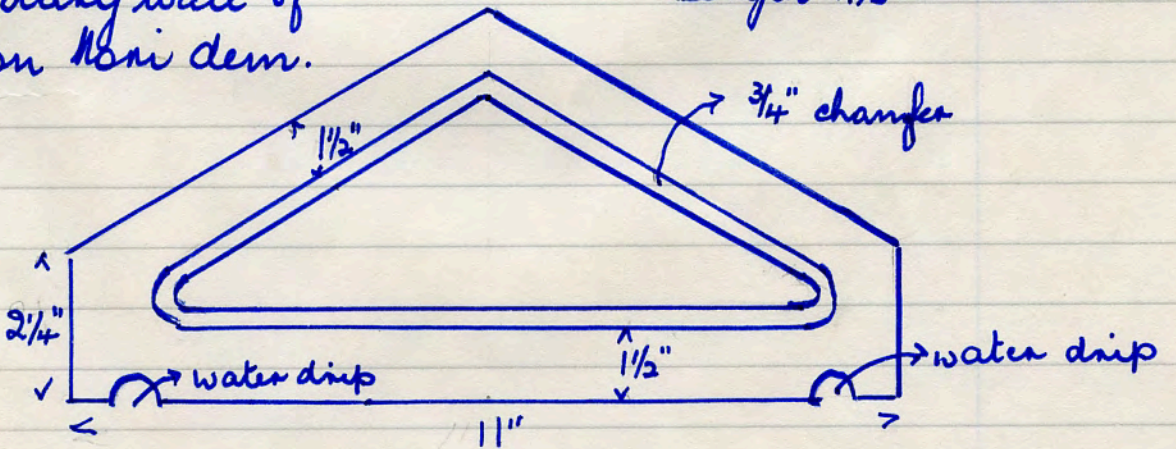

4478

No name, no number. Red wall capping return
JWR (stamped) moulders mark JJ 21 lbs.
Acc/ton Hosi dem. site

4479

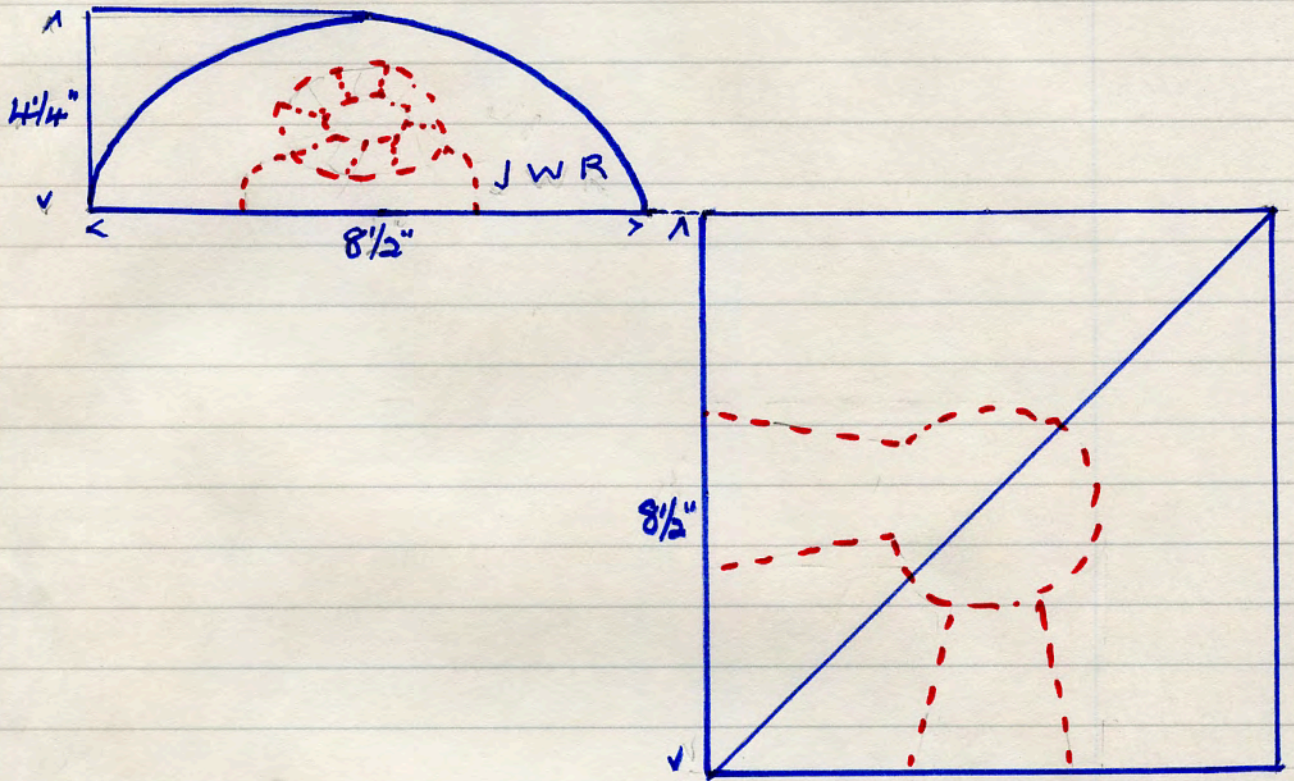

61 P 17 no name red T.C

18 lbs.

4480

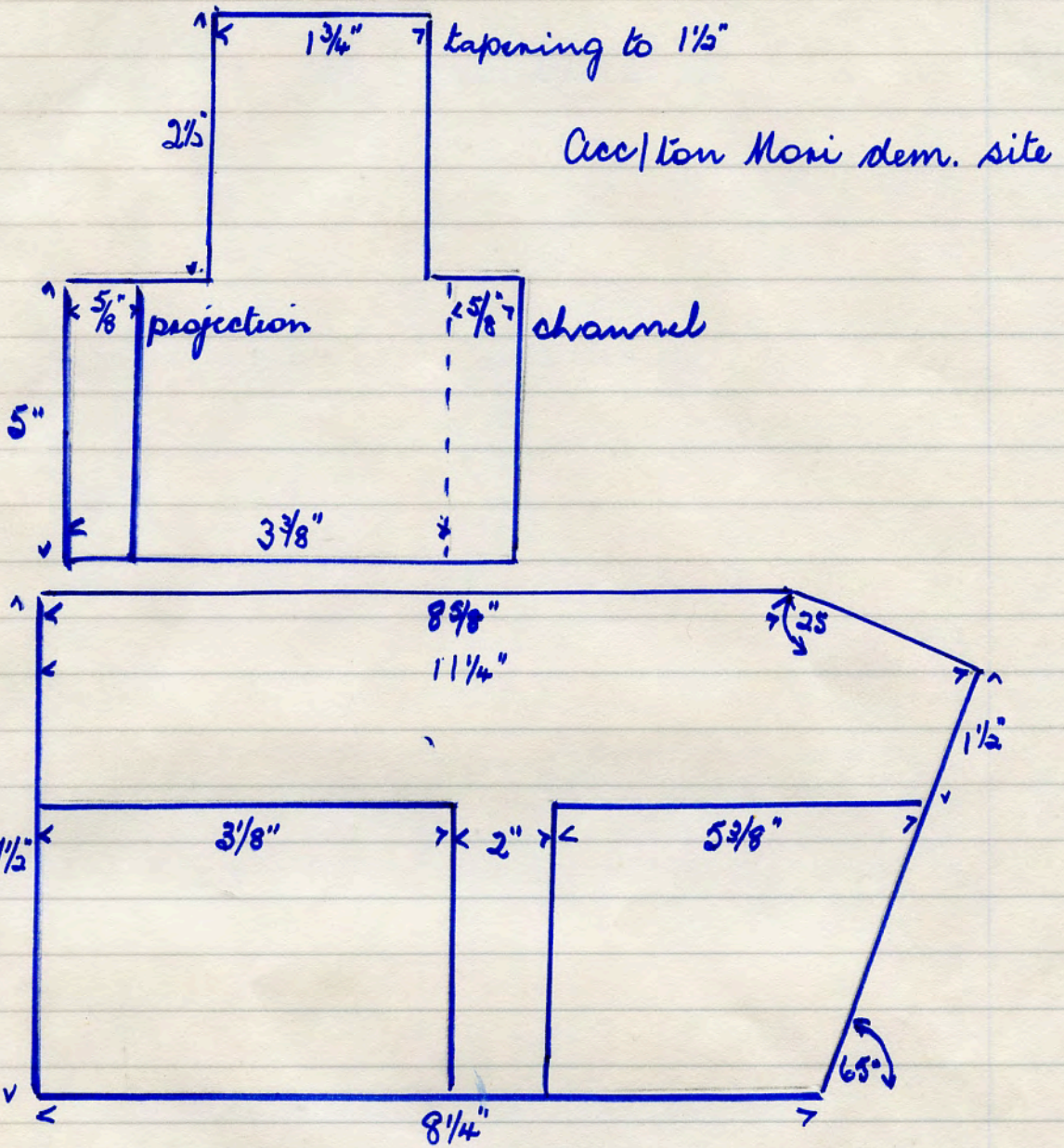

876 Y red T.C trough with spitter

28 lbs.

4481

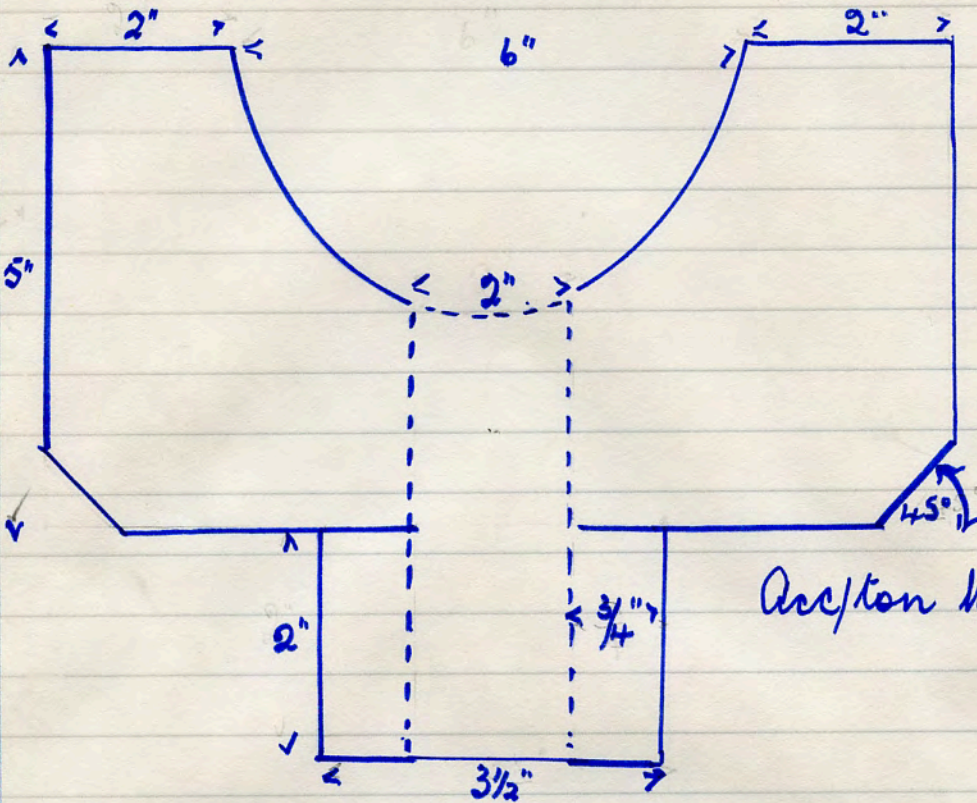

Accl ton Mosi dem. site

No name. No number

14 lbs

4482

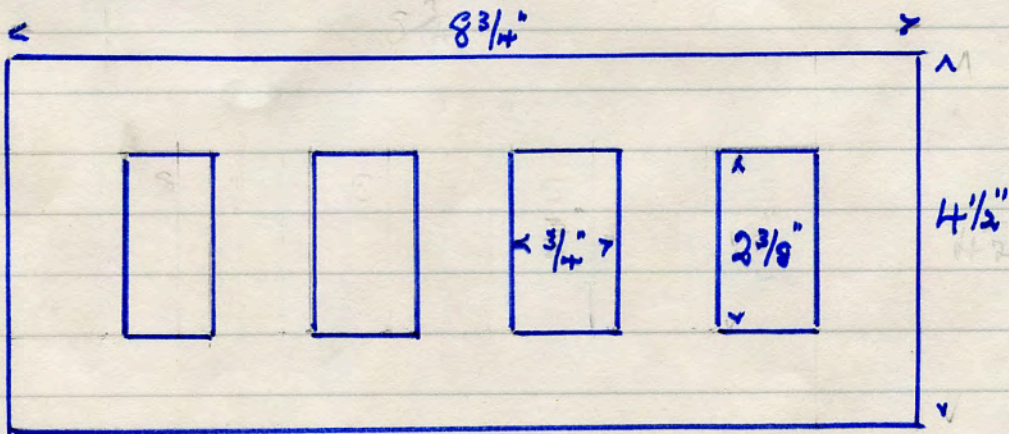

Accl ton Mosi dem. site.

BA (stamped) red lootia mould 7 lbs

4483

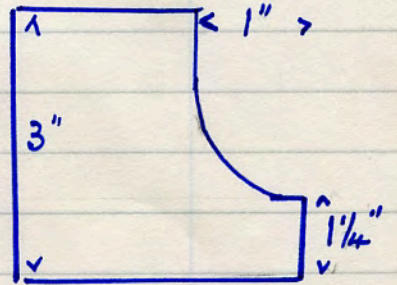
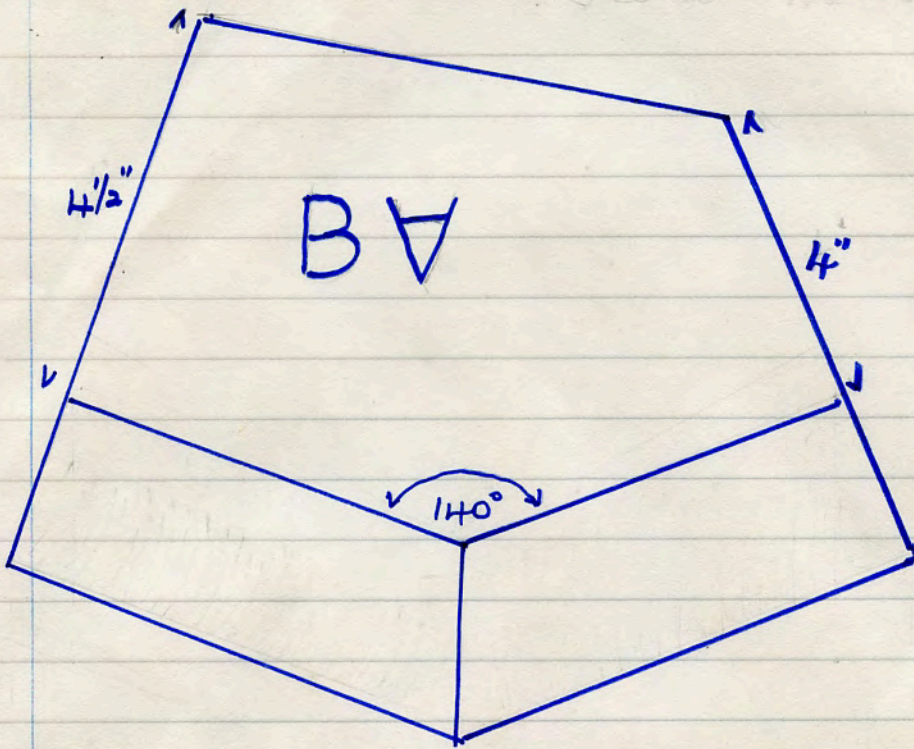

No name, no number. Decorative quadrant mould

4484

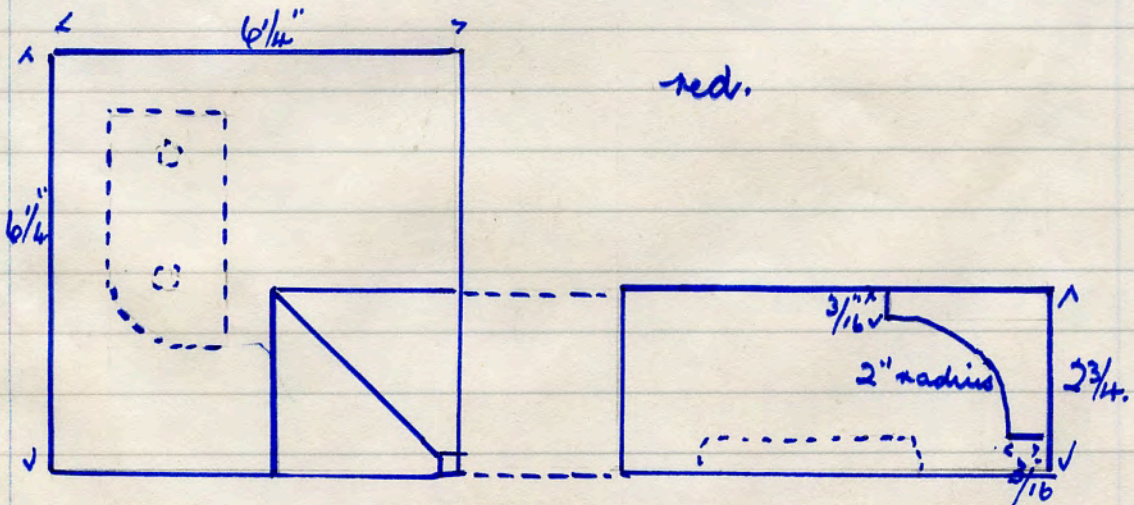

red.

9 lbs

Acc/Kon Hosi dem. silé

No number red T.C decorative return

9 lbs.

4485

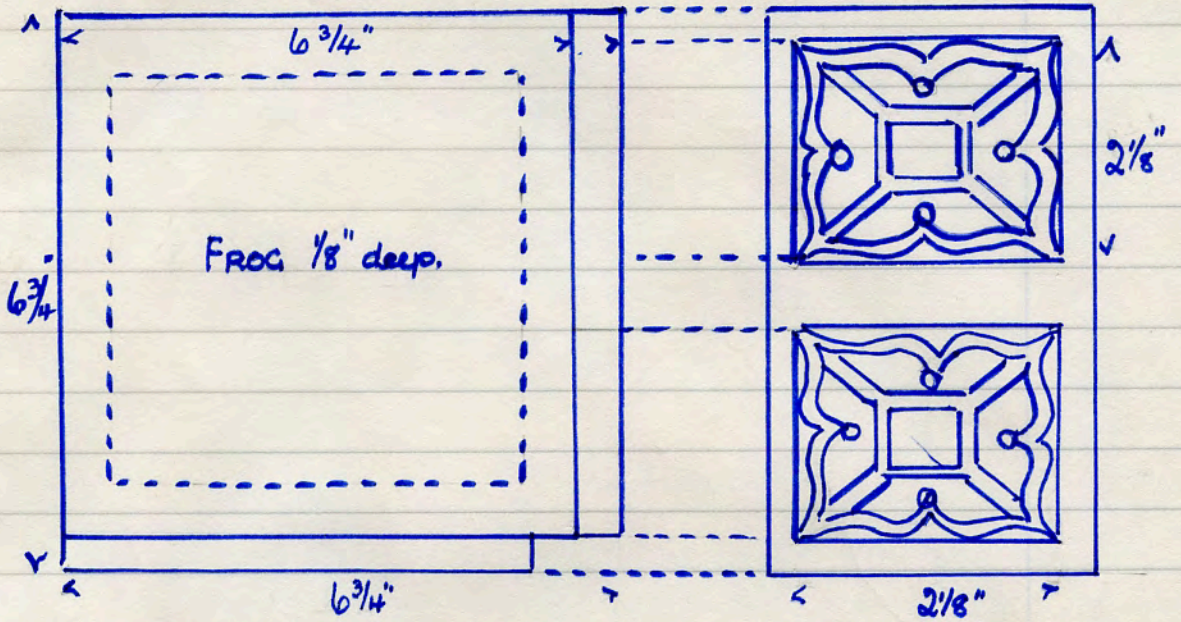

Acc/ton Mari dem. site

No number red T.C decorative return

9 lbs.

4486

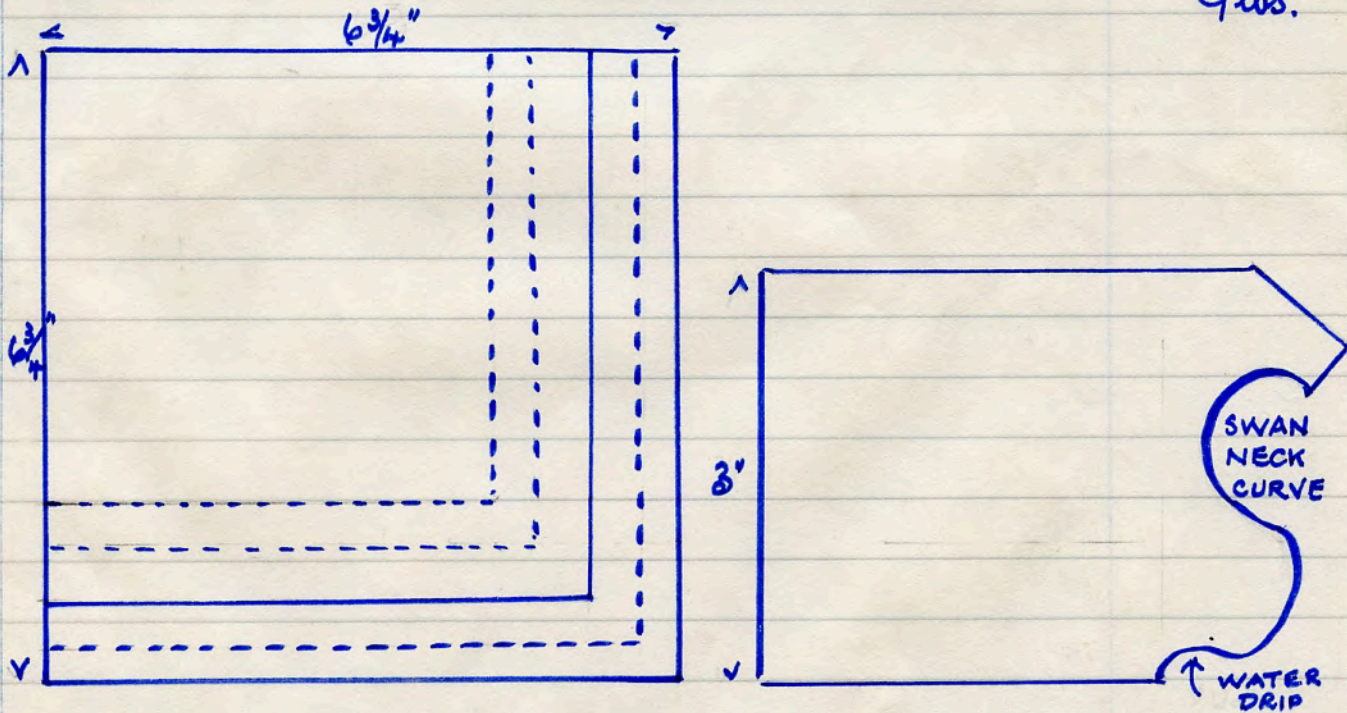

Acc/ton Mari dem. site.

MS

T.C dec. return. Quadrant mould.
Acc/ton hori dem. site

12 lbs

4487

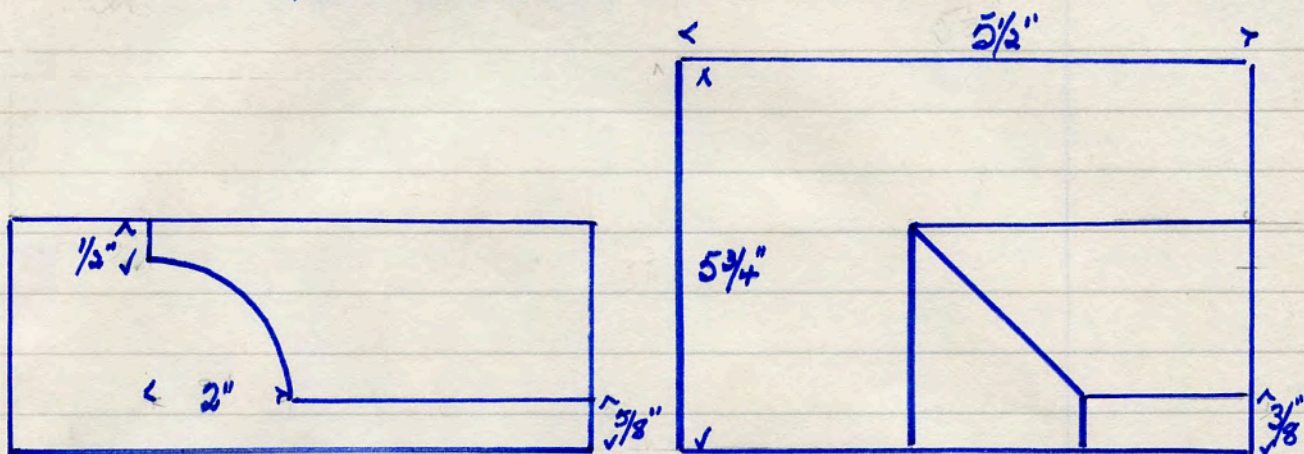

C (stamped) T.C dec. return Quadrant & scotia mould
Acc/ton hori dem. site

12 lbs

4488

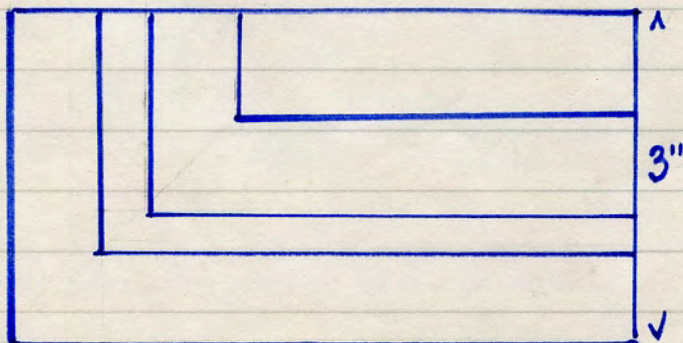
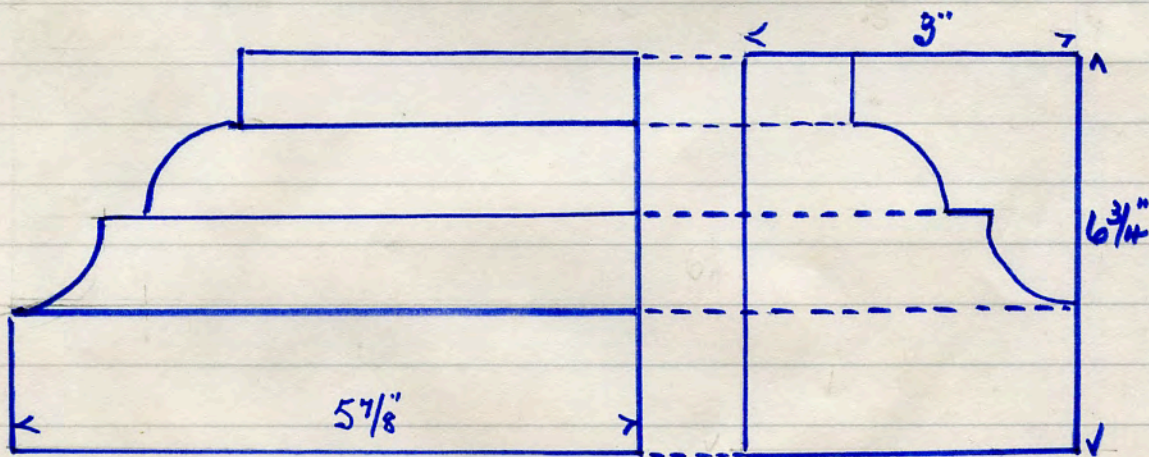

No name. No number red T.C. dec. return
 Acc/ton Nori dem. site

10 lbs

4489

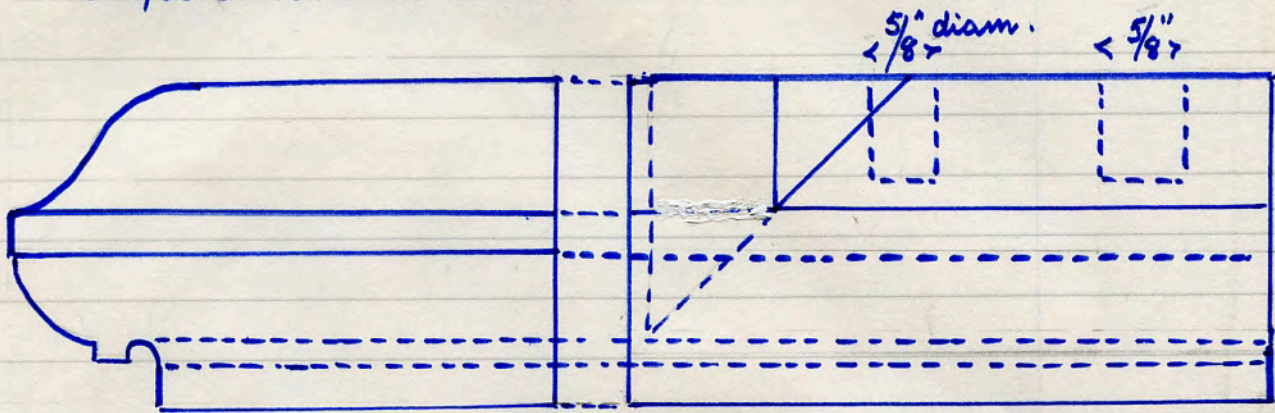

C (stamped) red T.C. dec. return

14 lbs.

4490

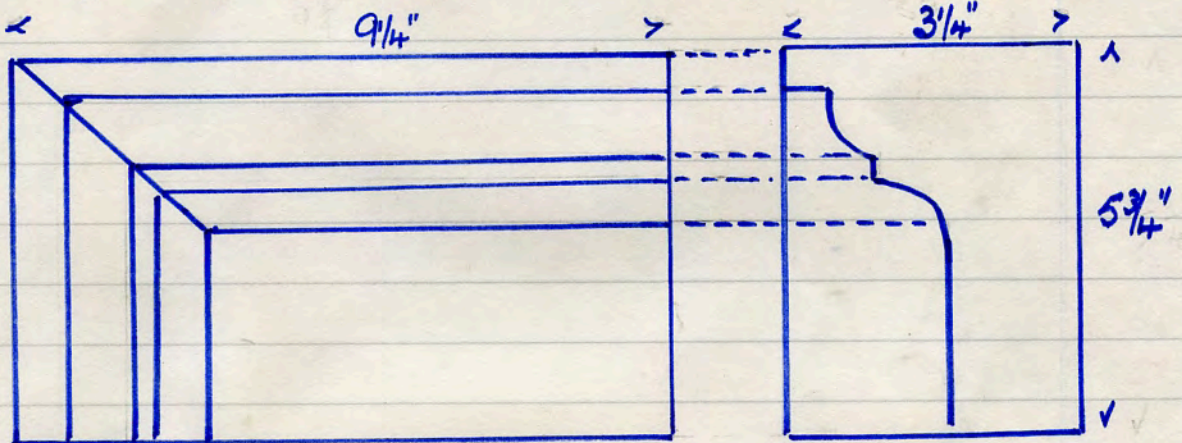

Acc/ton Nori dem. site.

ACCRINGTON
 NORI
 BRICK & TILE CO LD

stamped on reverse. red T.C.
 plain return with chamfer.

14 lbs

4491

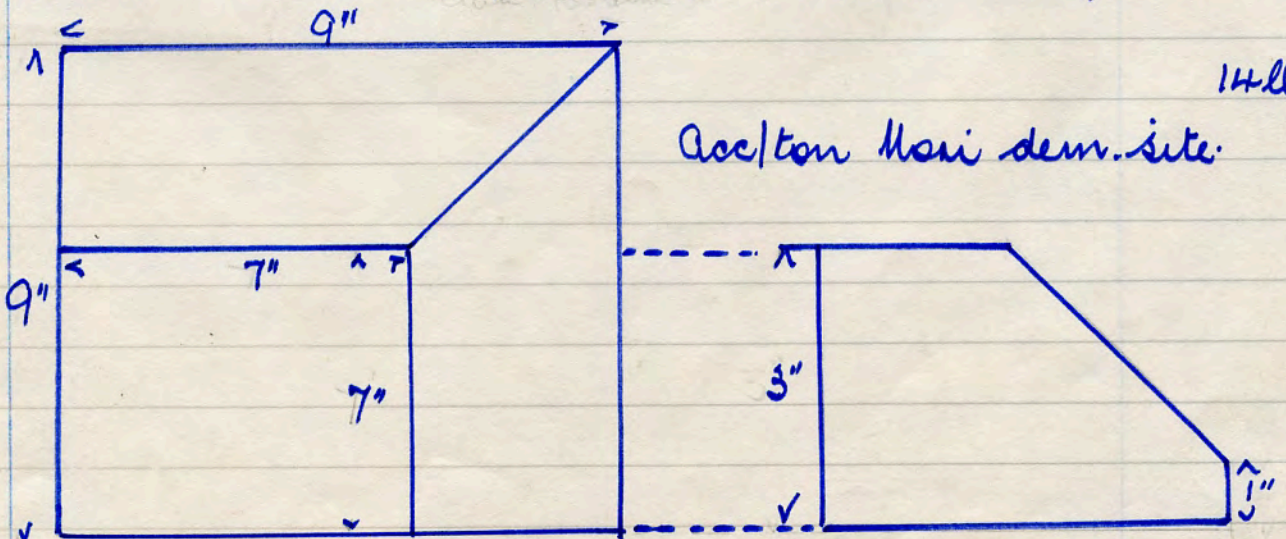

Acc/ton Nori dem. site.

74 red T.C dec. return number stamped
Acetone Mori dem. site

11 lbs

4492

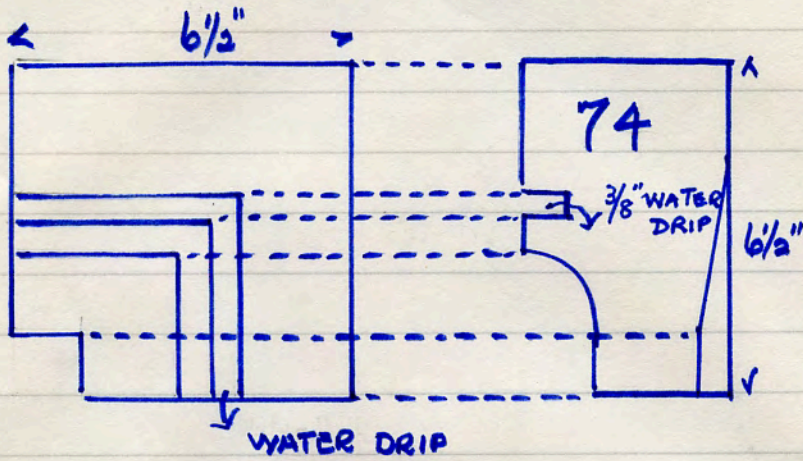

23 (stamped) red T.C dec. return.

10 lbs

4493

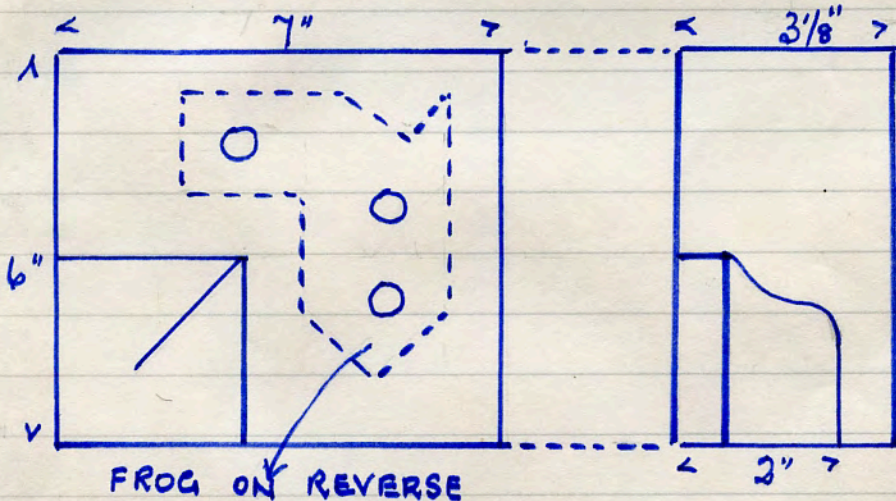

INCLUDING 3 PRESSURE POINTS

Acetone Mori dem. site

No number, red T.C. dec. return & stop end.

16 lbs

4494

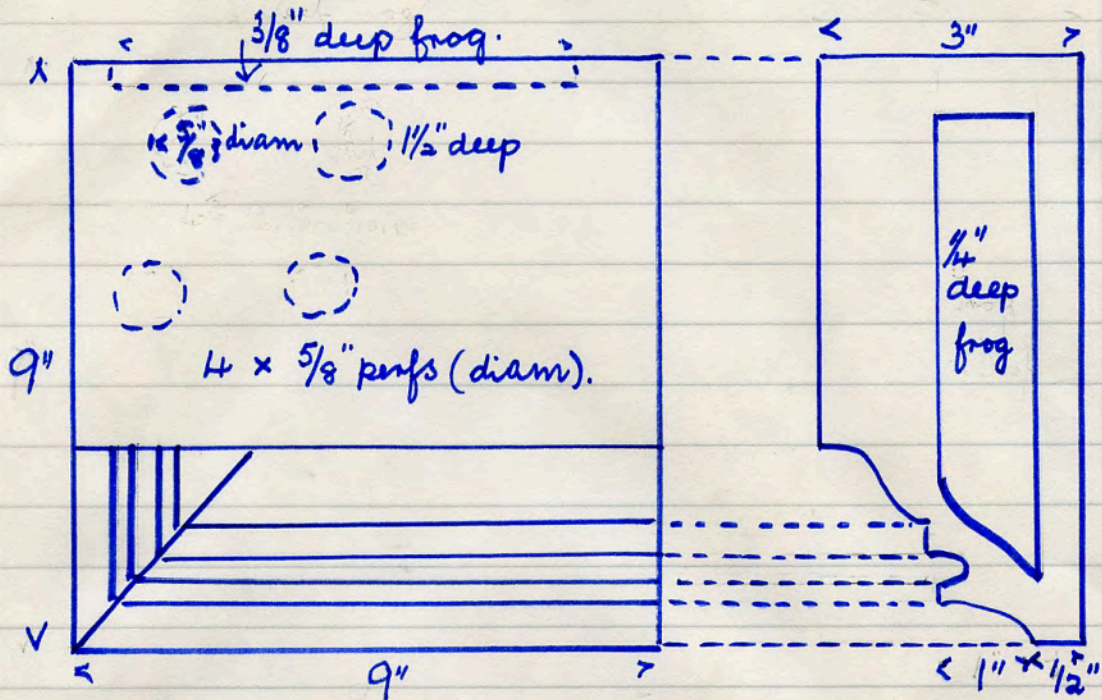

Acc/ton Noxi dem. site

75 red T.C dec. return.

Acc/ton Noxi dem. site

14 lbs.

4495

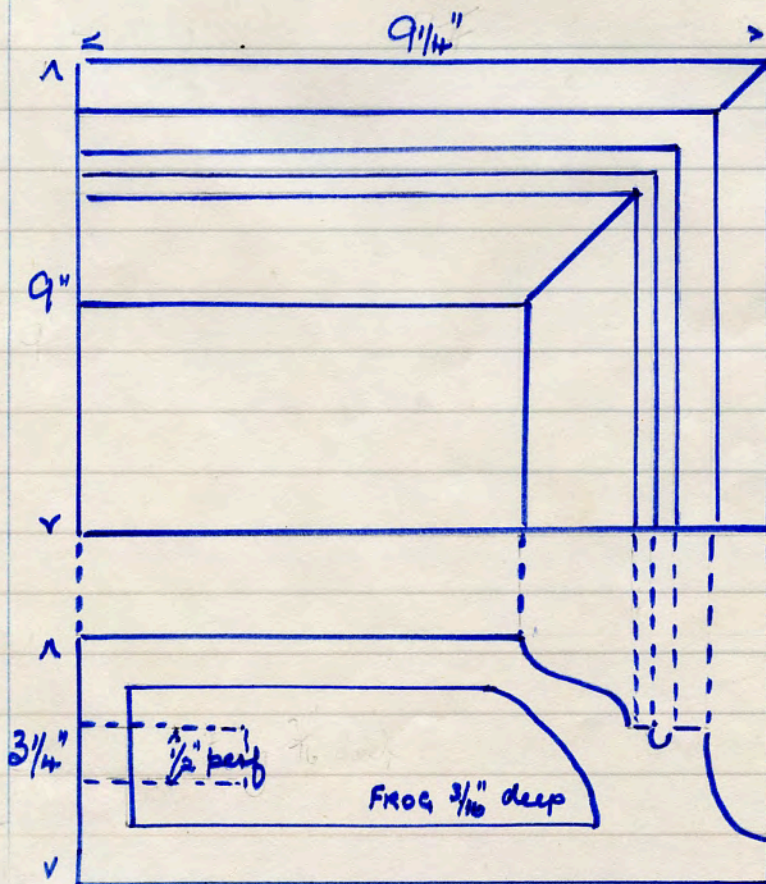

72 (stamped on end) red T.C dec. return - stop end

4496

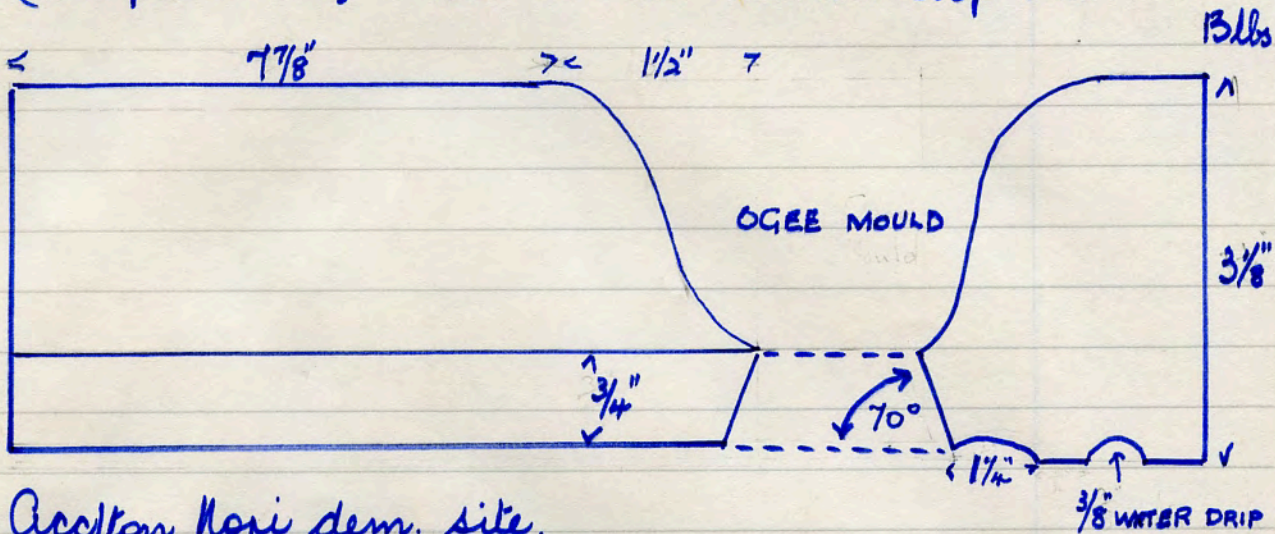

32 (stamped, on base) red T.C dec. return.

4497

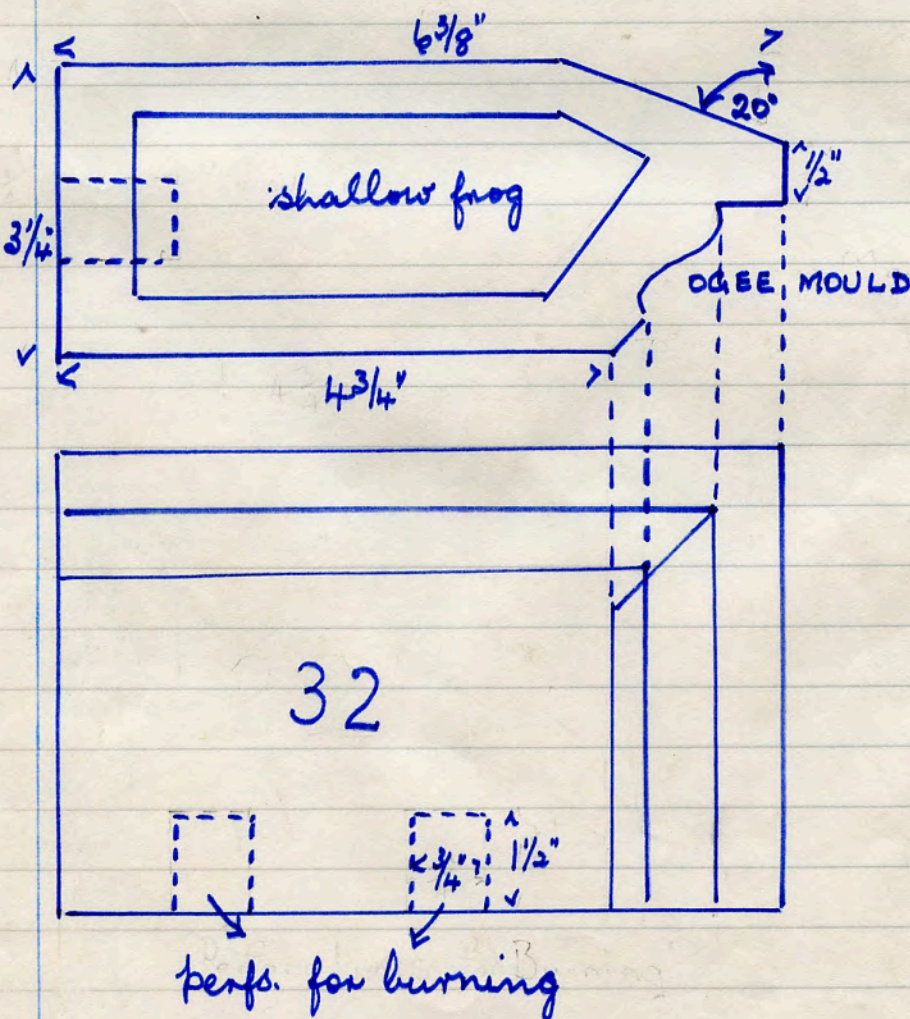

No name. No number. Red T.C quadrant mould
 C1 stamped on edge. From a window of
 Broadfield School dem.
 Rochdale.

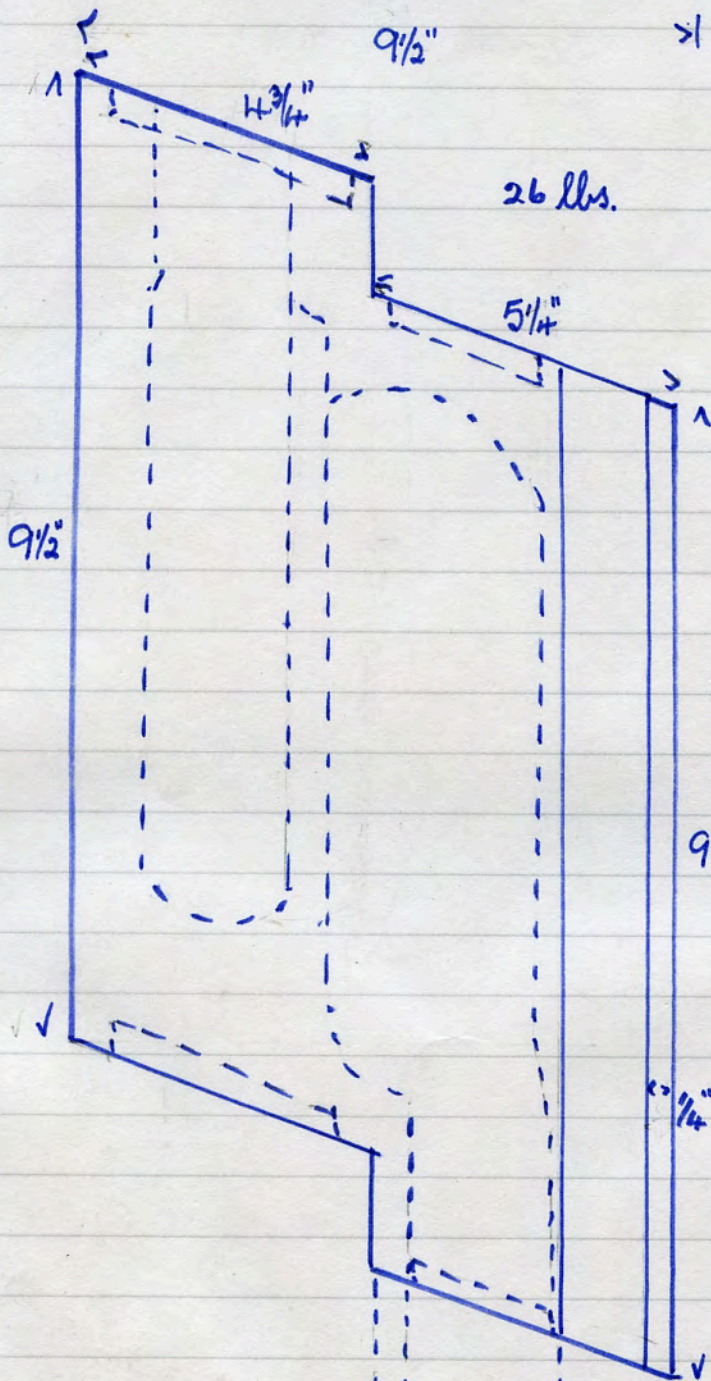

26 lbs. presumed trunk & Hewall
 Knabow.

3. 9. '89

4498

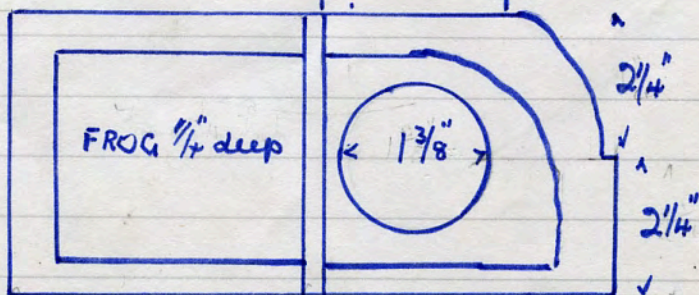

2 1/4"

2 1/4"

FHG no name. special brick made by Monk & Newall, Ruabon.

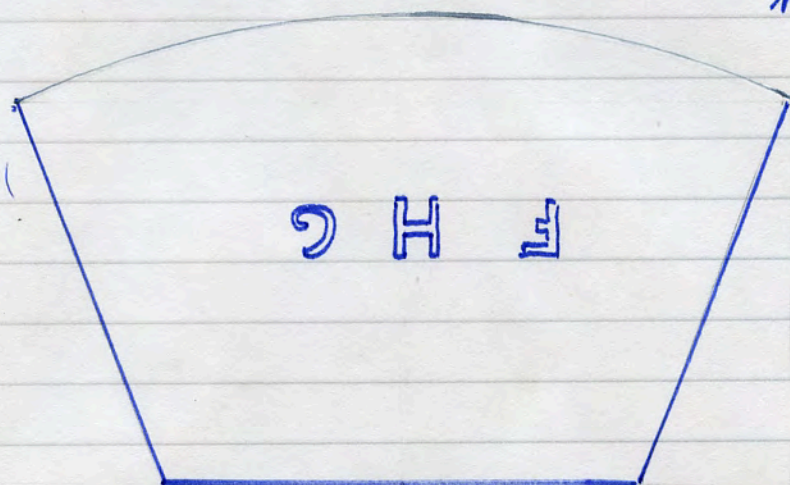

9 1/2" x 5" x 3 1/8"
9 lbs. red
FHG stamped

4499

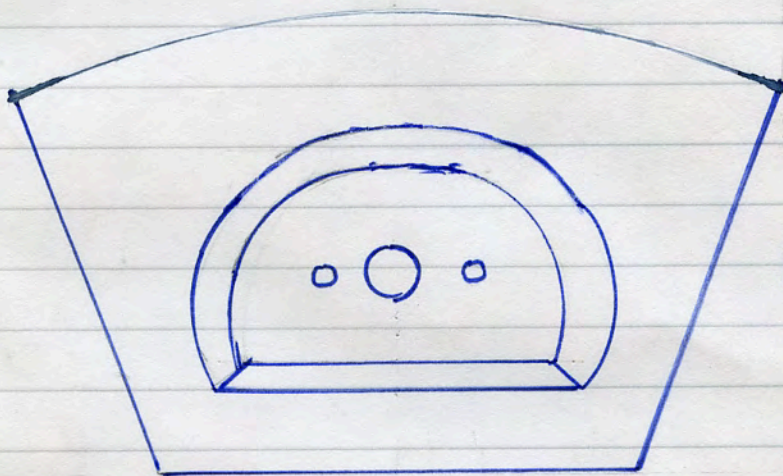

frog on rev. only.

Broadfield School dem. Rochdale. 13. 8. '89

FH2 no name. special brk made by Monk & Newall Ruabon.

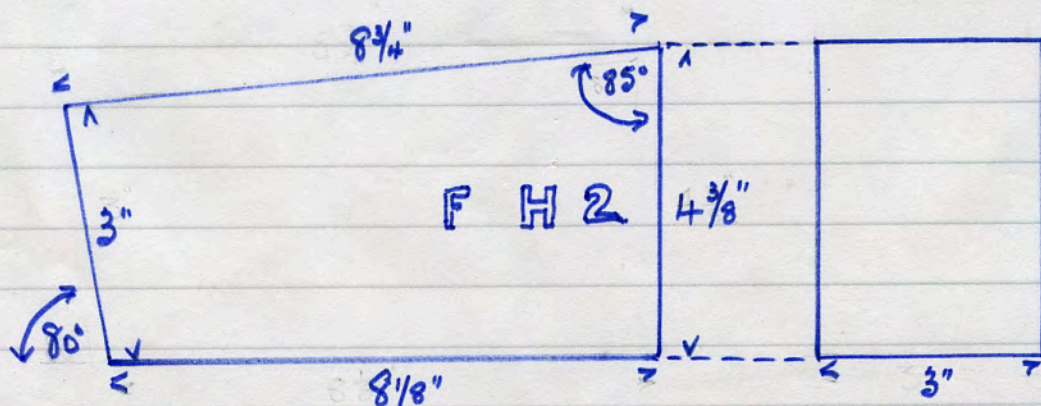

7 1/2 lbs
red

4500

Broadfield School dem. Rochdale. 13. 8. '89

Red T.C key brick to window head, Broadfield School, dem
28 lbs. Rochdale

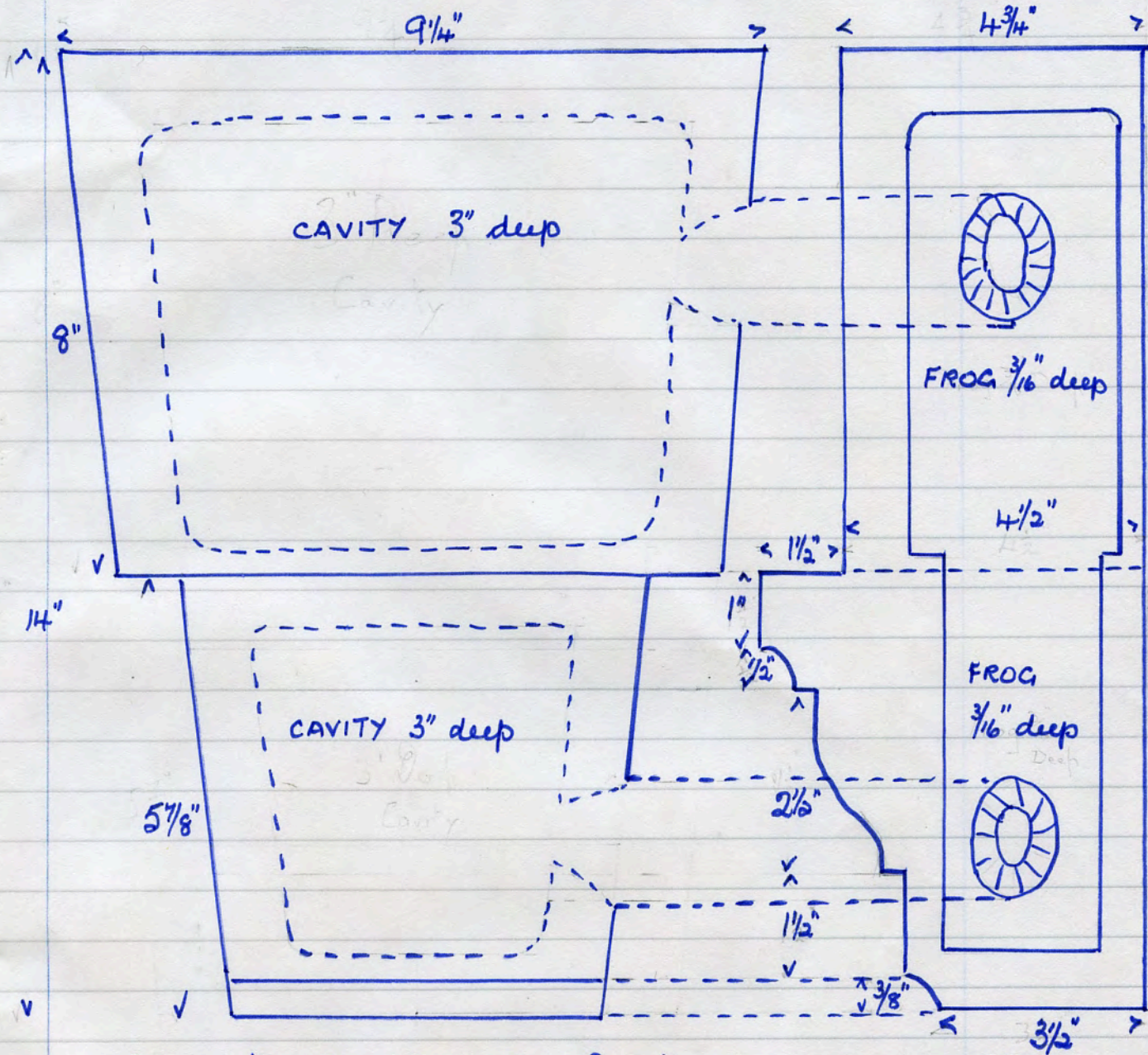

4501

from thank → Newall, Raabon.

22. 10. '89

4502 R 446 red T.C junction between pitch of roof and horizontal
70 lbs

Broadfield School dem. Rochdale.

No 1 drawing

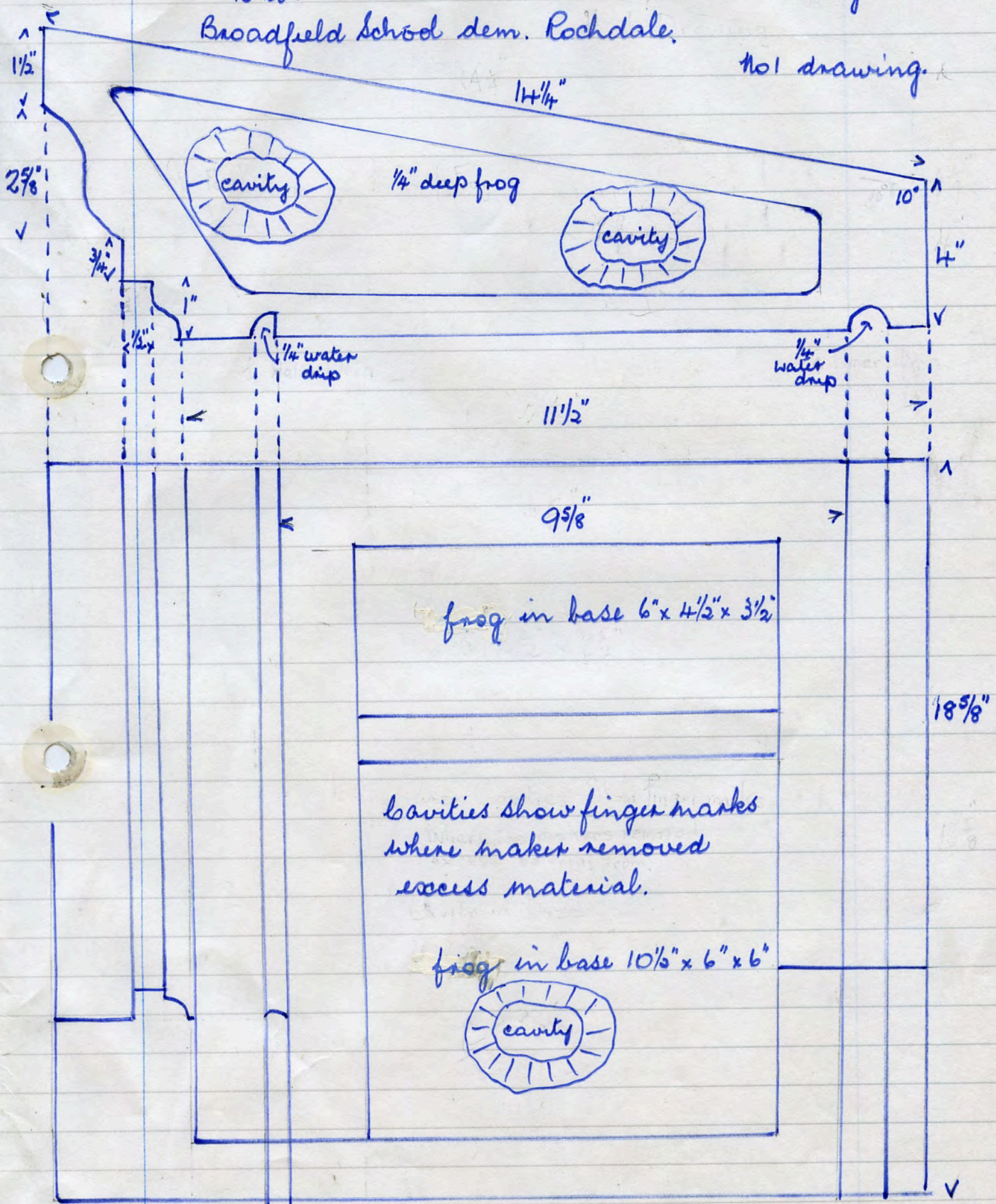

No 2 drawing

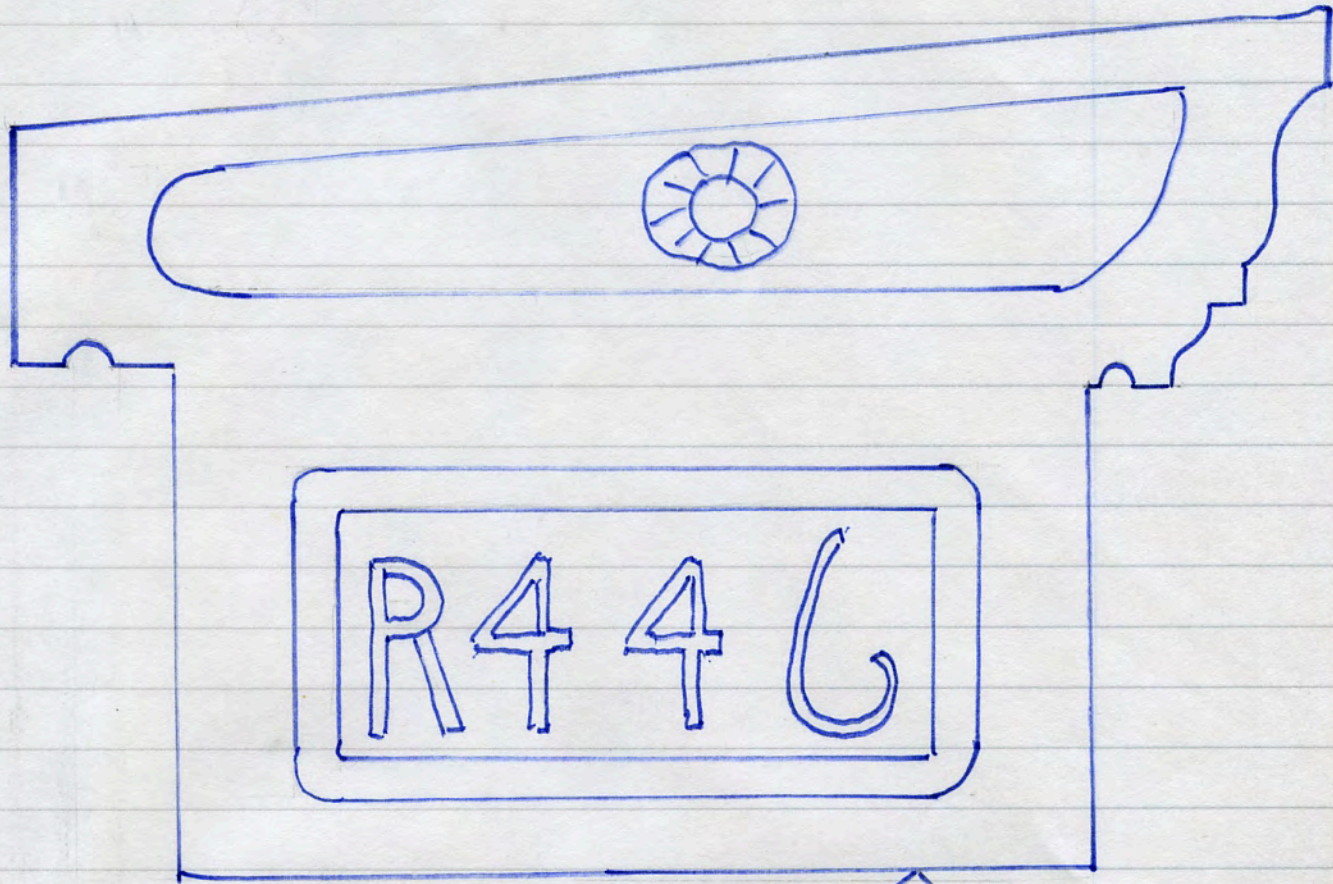

No 3 drawing.

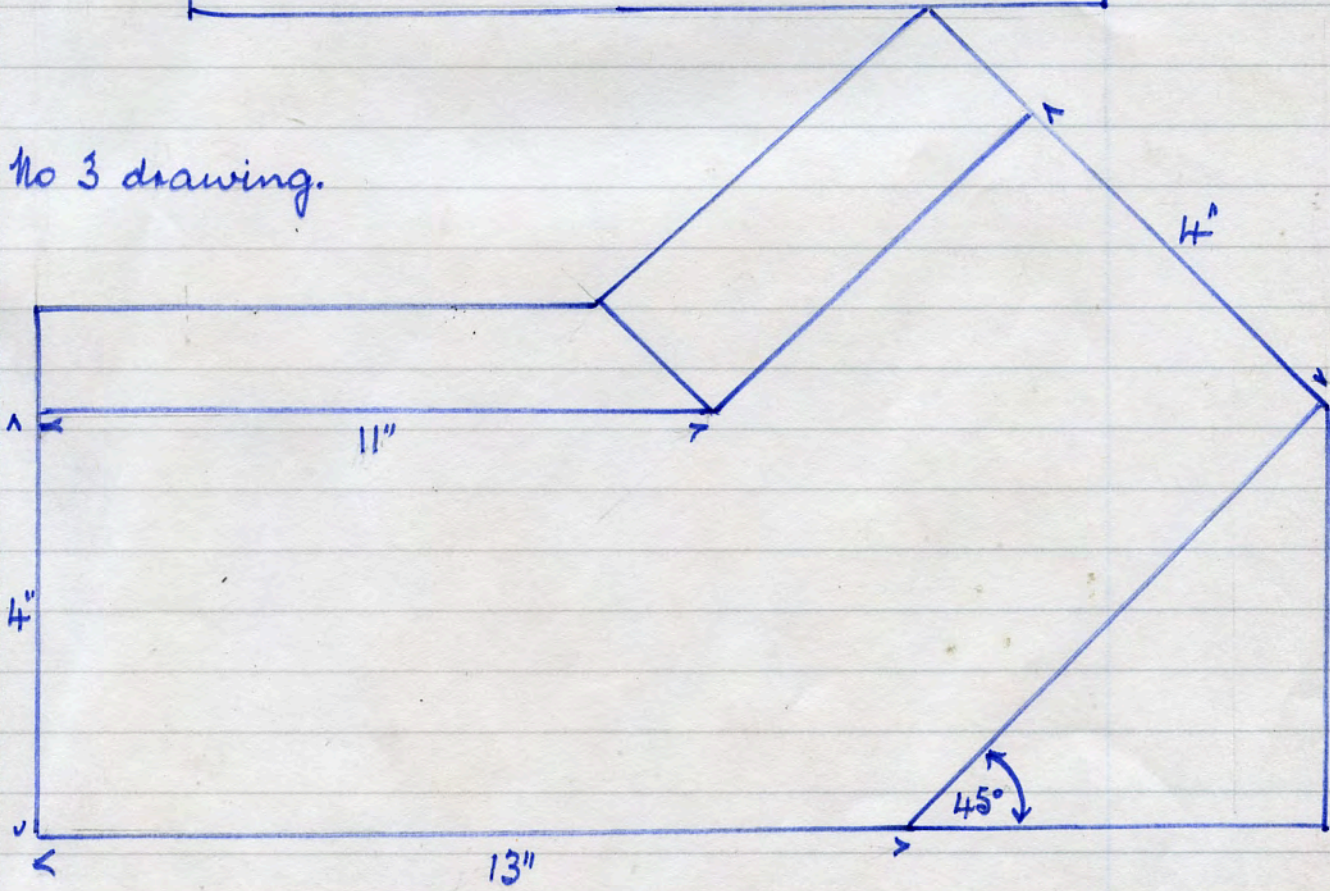

G. W. Lewis's Tiles Ltd., Stockingford, Munceton.

ROSEMARY roof tile (1936 production)

2 lbs. $10\frac{1}{2}'' \times 6\frac{1}{5}'' \times 7\frac{1}{16}''$ red

no panels, 2 fixing holes, $\frac{3}{16}''$ diam.

3 lugs for fixing.

letters clearly incised.

Mrs & Mrs H. Brown, Cannock Chase.

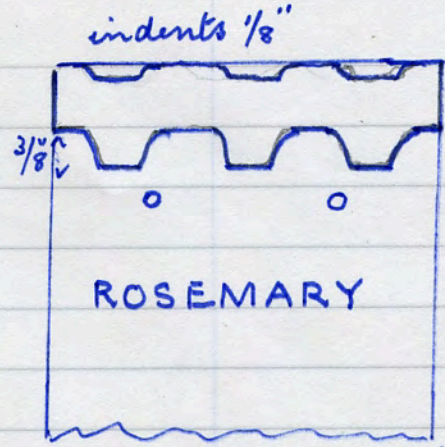

4519

No name, no number, red dec. string course T.C

9 lbs.

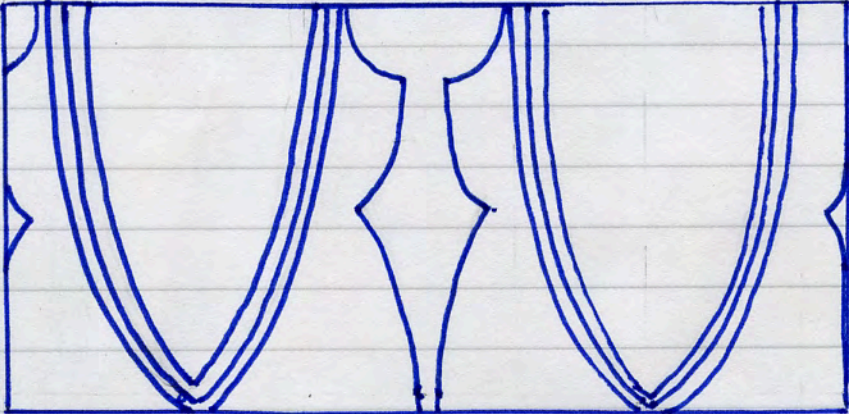

manufacturer unknown.

3"

4523

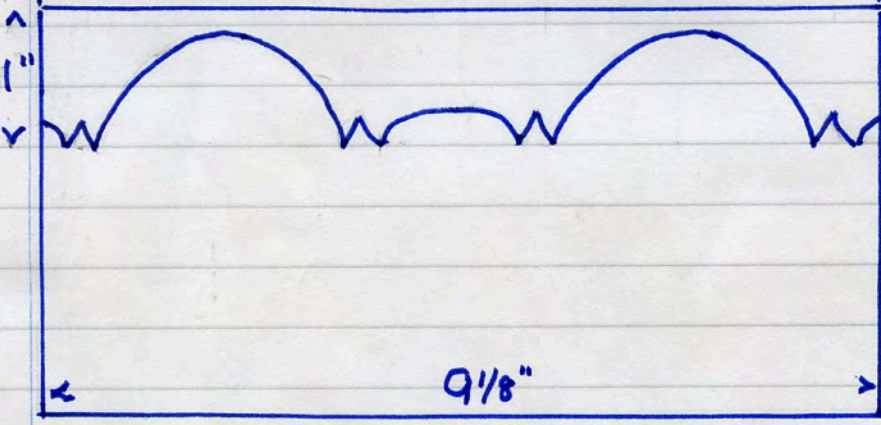

4 3/8"

9 1/8"

MINTON & HOLLINS & CO PATENT TILE WORKS,

STOKE UPON TRENT No 25 RED octagonal tile

2 lbs. $6\frac{1}{4}" \times 6\frac{1}{4}" \times \frac{3}{8}"$

cream glaze on face.

7 bars on rev. $\frac{1}{4}" \times \frac{1}{16}"$

letters in relief.

Broadfield School dem. Rochdale. (built 1899).

4524

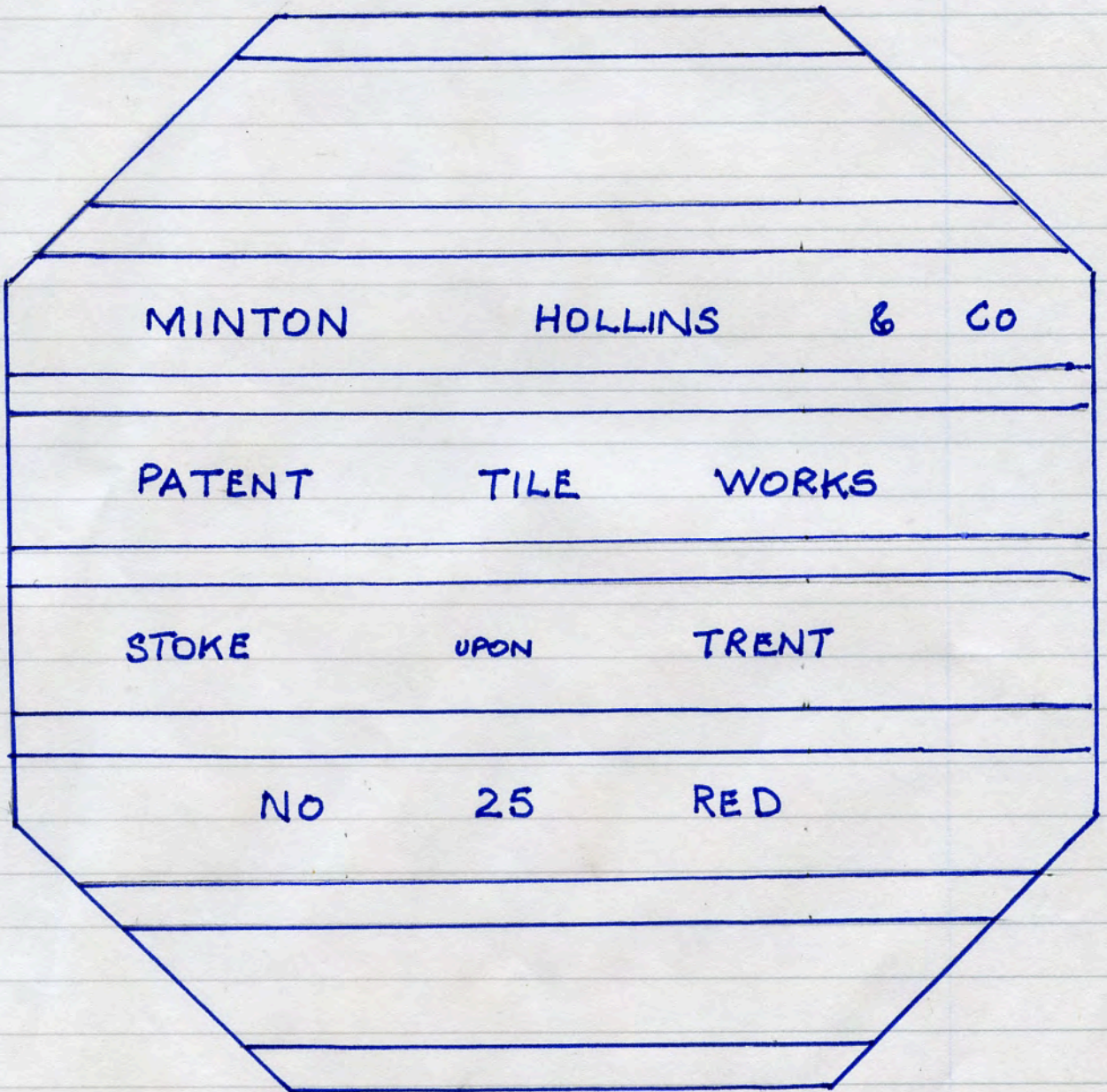

F 2 red T.C gauged arch piece
10 lbs.

4526

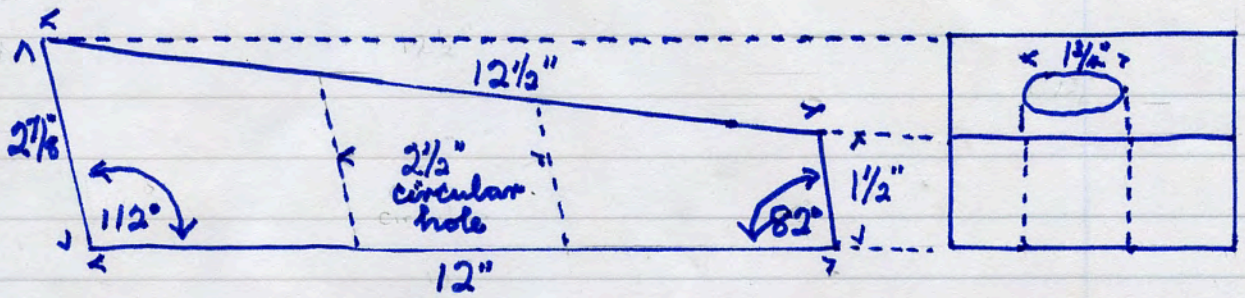

letters stamped on end.
Broadfield School dem. Rochdale. 26. 12. '89

4527

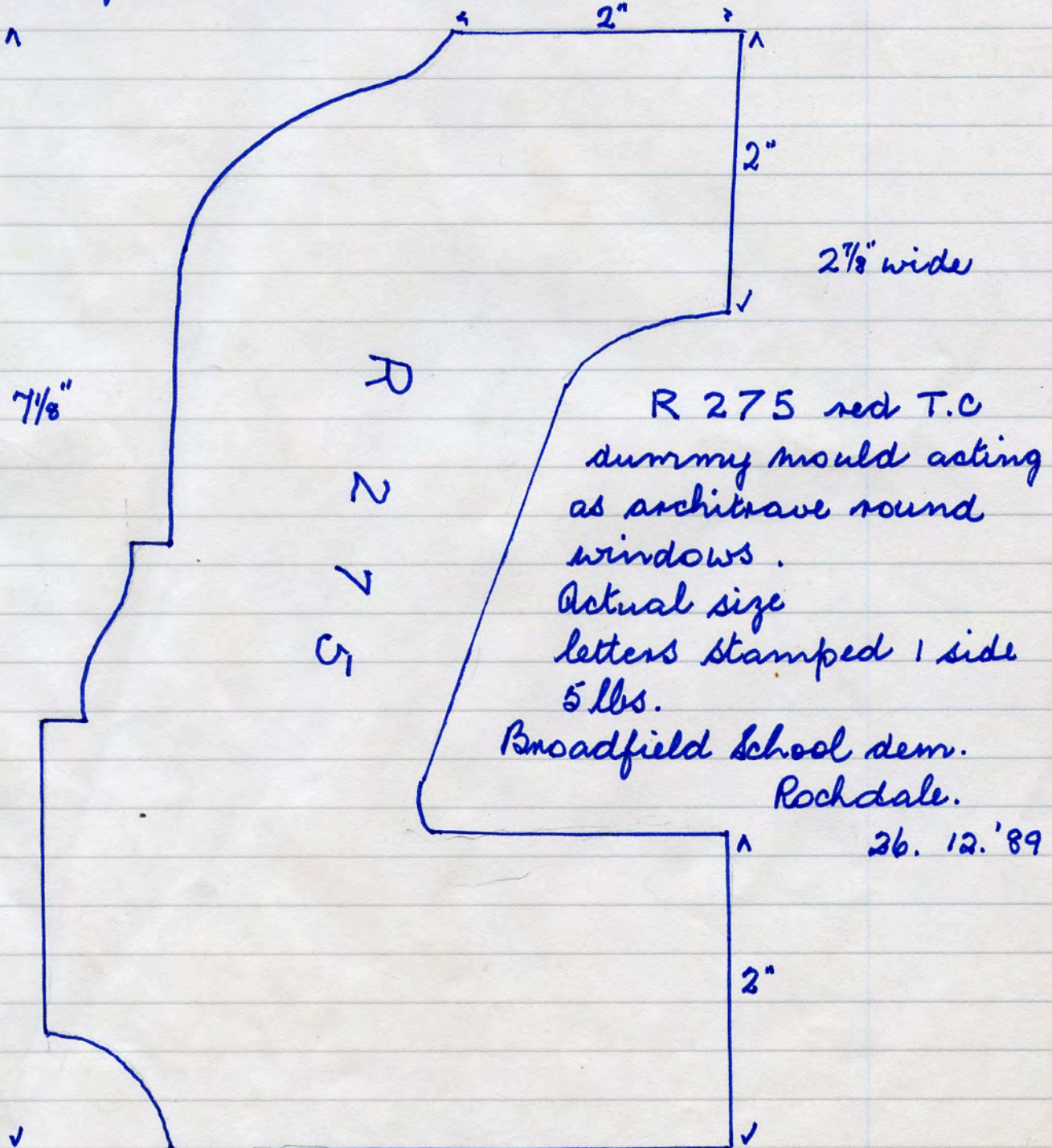

W & W. Whittaker, Blackburn, Dec. 1882.

W o W W red. jamb.

9 1/2 lbs. 8 3/4" x 4 5/16" x 3 1/16"

single panel each side 1/5" deep obr.

shallow " rev. double bull nose.

letters deeply incised.

dem. of Theatre, Boulevard, B/burn

31. 12. '89

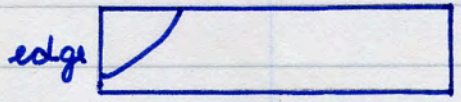
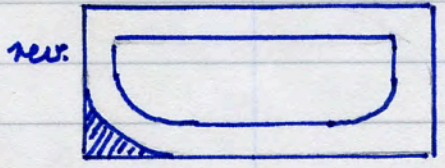
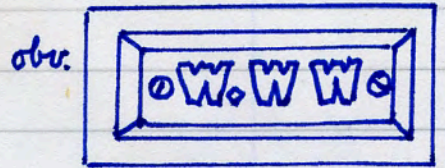

4532

No name. dec. red ridge tile

14 lbs 13" x 10 1/4" x 10"

dem. Dale St. Accrington 14. 1. '90

4544

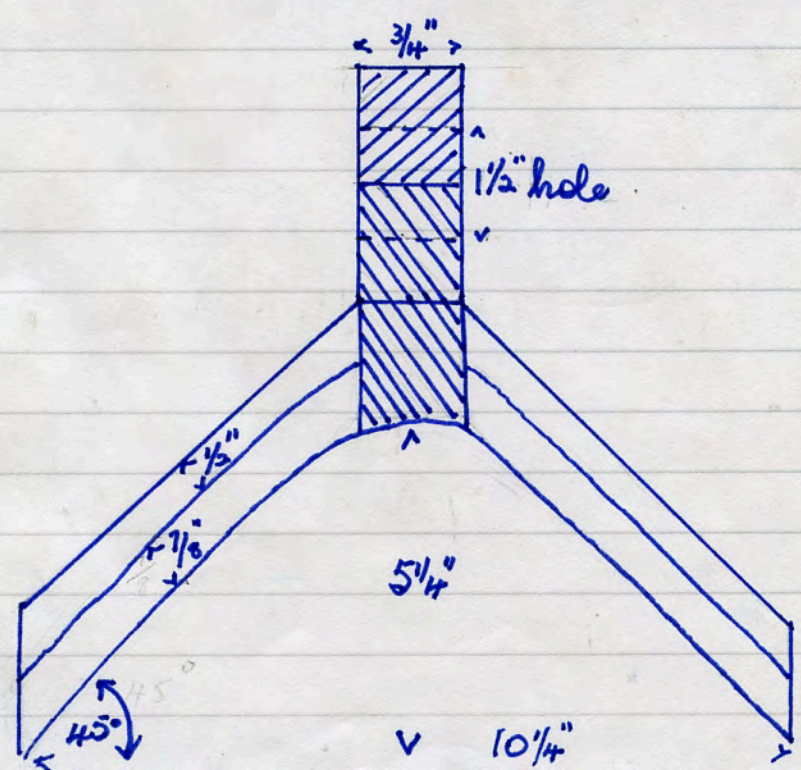
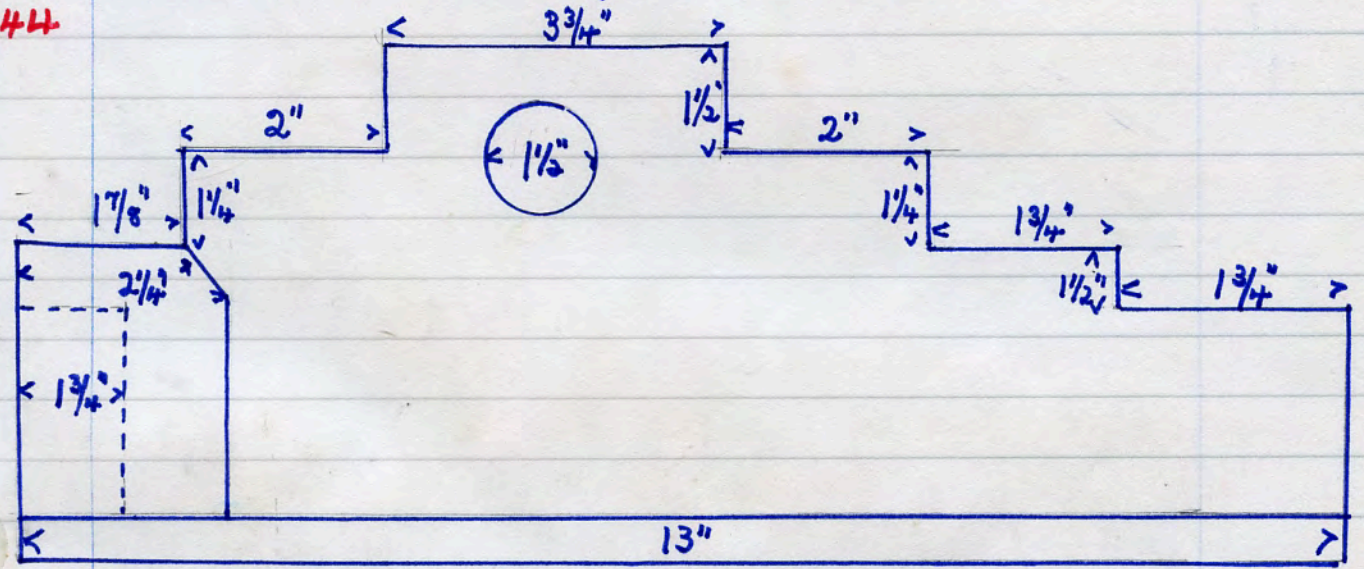

4546.

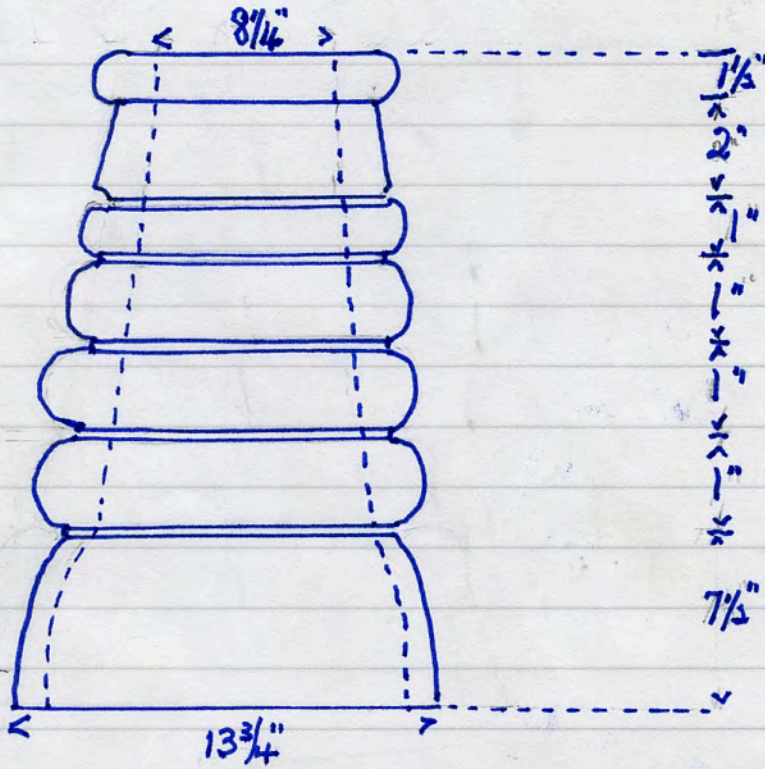

No name red clay chimney pot. 28 lbs.
 presumed to have been made by the Holding Pottery
 family who lived in Oswaldtwistle for 150 years.
 dem. Antley St, Accrington 13. 1. '90

4556

No name. 1/2 bull nose. dec. (Matthew Bros. B/burn).
 9 lbs. 9" x 4 1/2" x 3"
 single panel one side only.
 3/4" groove in rev. side.
 Bennington Rd. B/burn. 4. 3. '90

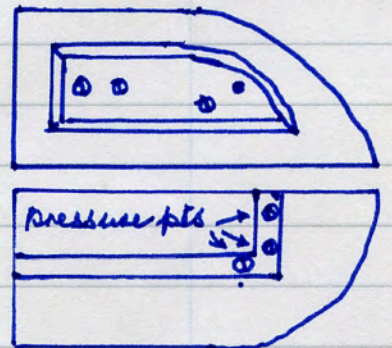

No name. red T.C. (Monk & Newell, Ruabon). 17 lbs.

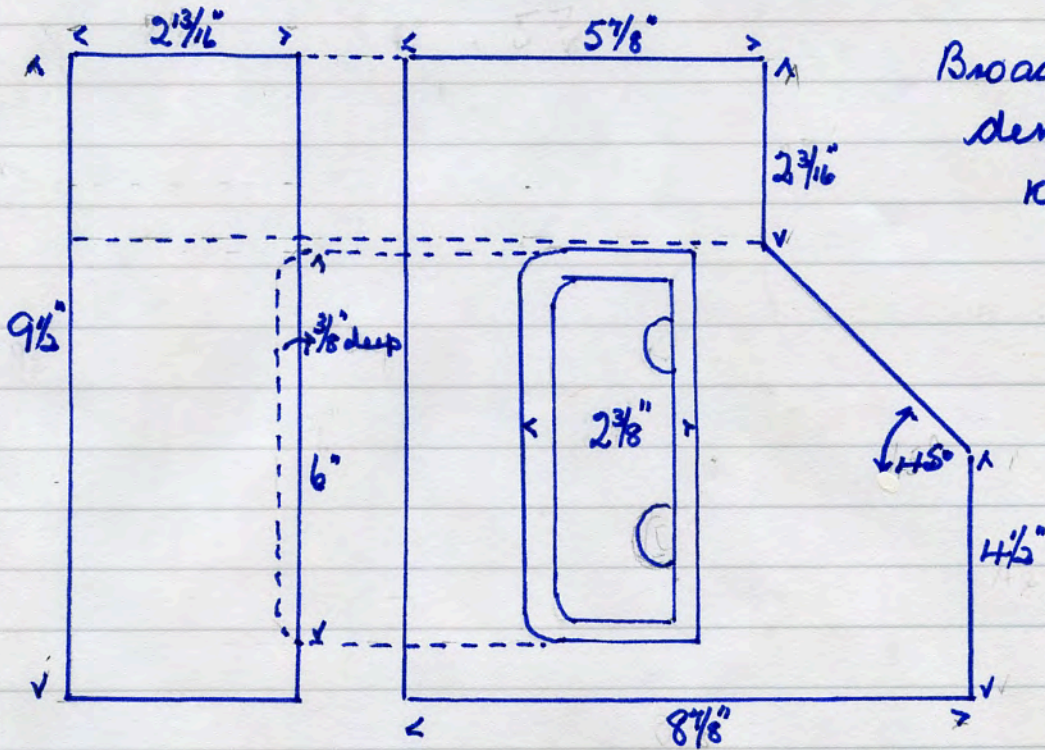

Broadfield School
dem. Rochdale
10. 3. '90

4554

No name. red T.C. Square finial head (broken top)
6 lbs.

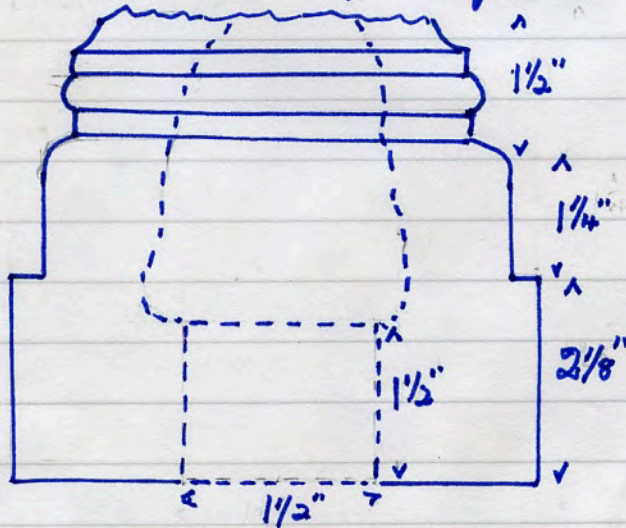

stamped R 289
and  on base.

Broadfield School
dem. Rochdale
10. 3. '90

4558

This finial was held in place by a piece of timber driven
in through gap in base.

4559.

No name. red T.C. flower dec. 2 lbs. 1 1/2" thick

Broadfield School dem.
Rochdale.

10. 3. '90



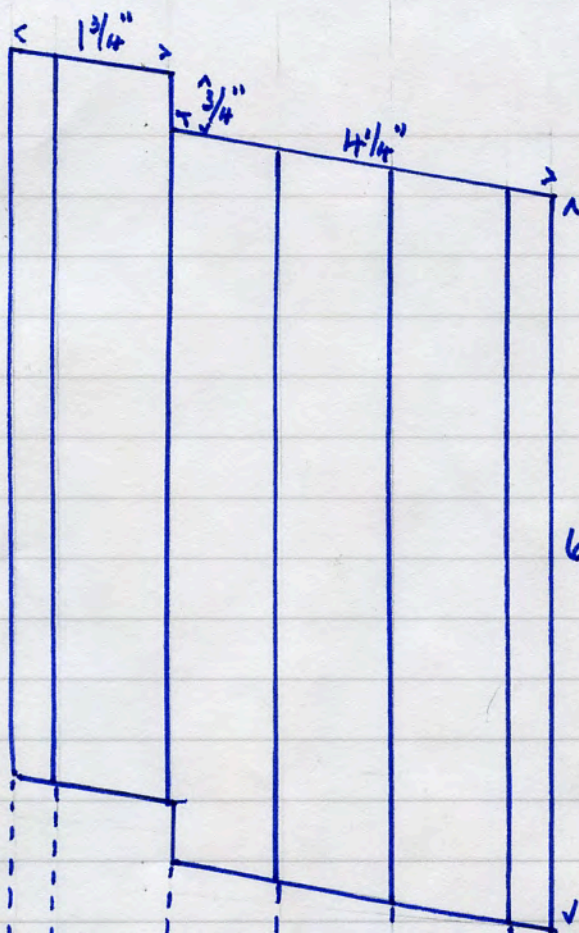

No name. red T.C.
 section through door casing
 (Monk + Hewell).

2 brks tall. 16 lbs.
 stepped horizontal joints
 D X stamped on rebate

6 1/4" Broadfield School dem.
 Rochdale. 10. 3. 90.

4560

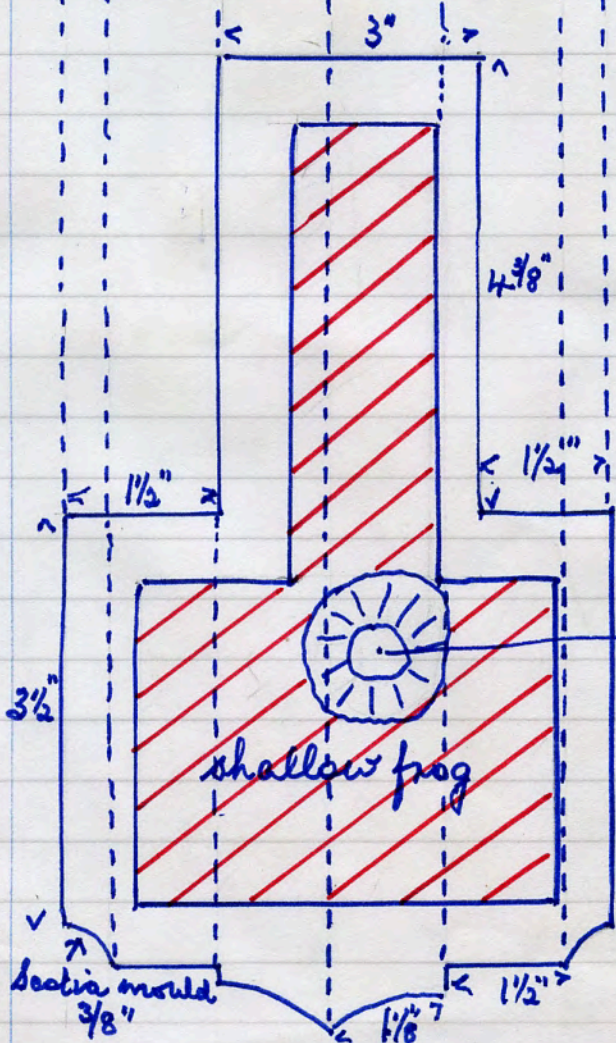

2 perf. 1 1/2" tapering to 1"

No name. red T. C. dec. to window or door
 2.6 lbs. (Monk + Hewell).

F scratched on flat.

Broadfield School dem. Rochdale. 10. 3. '90

4561

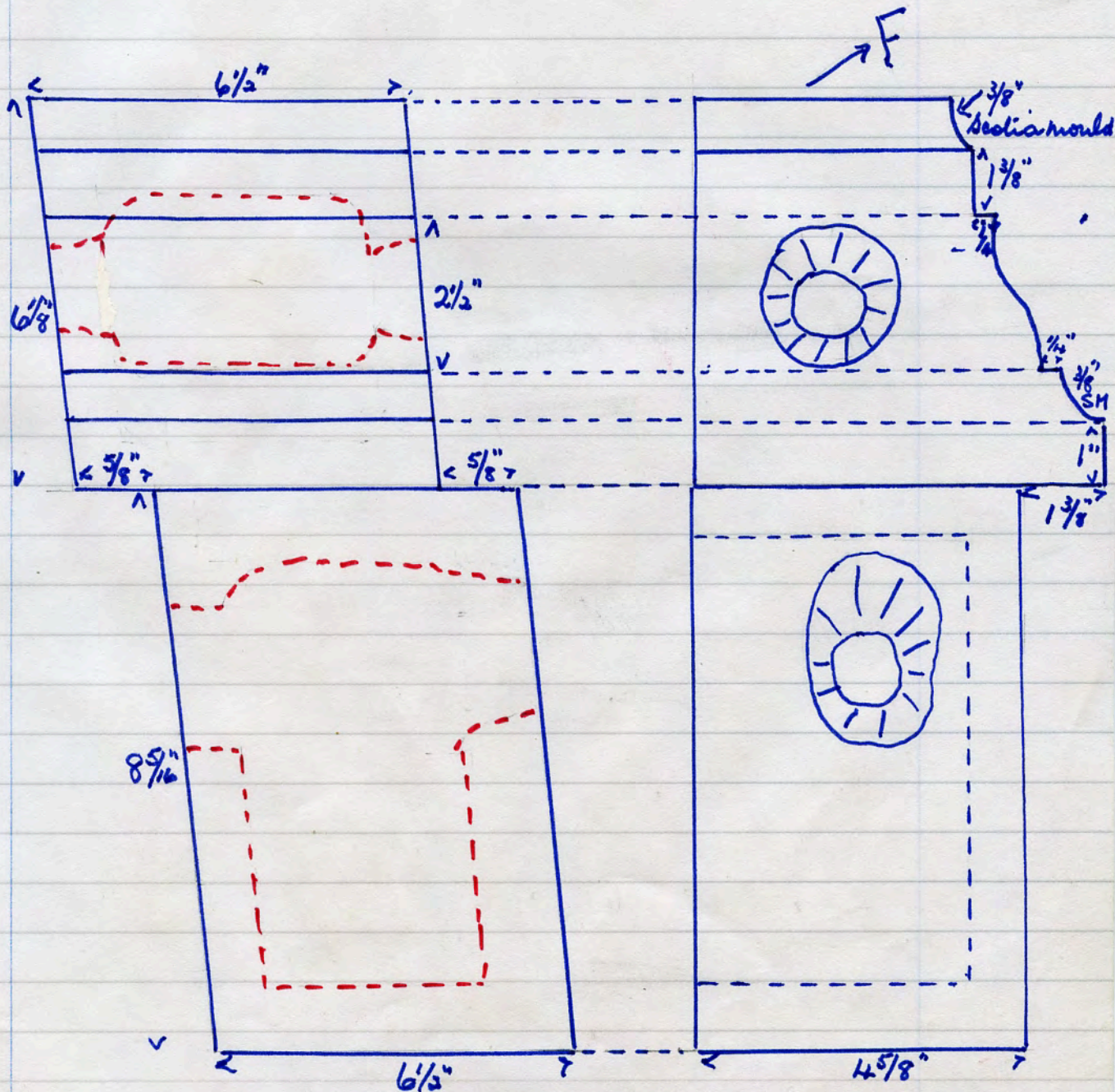

No name R2 red. 7 lbs $10\frac{1}{2}$ " overall \times $4\frac{3}{8}$ " \times $2\frac{7}{8}$ "

4582

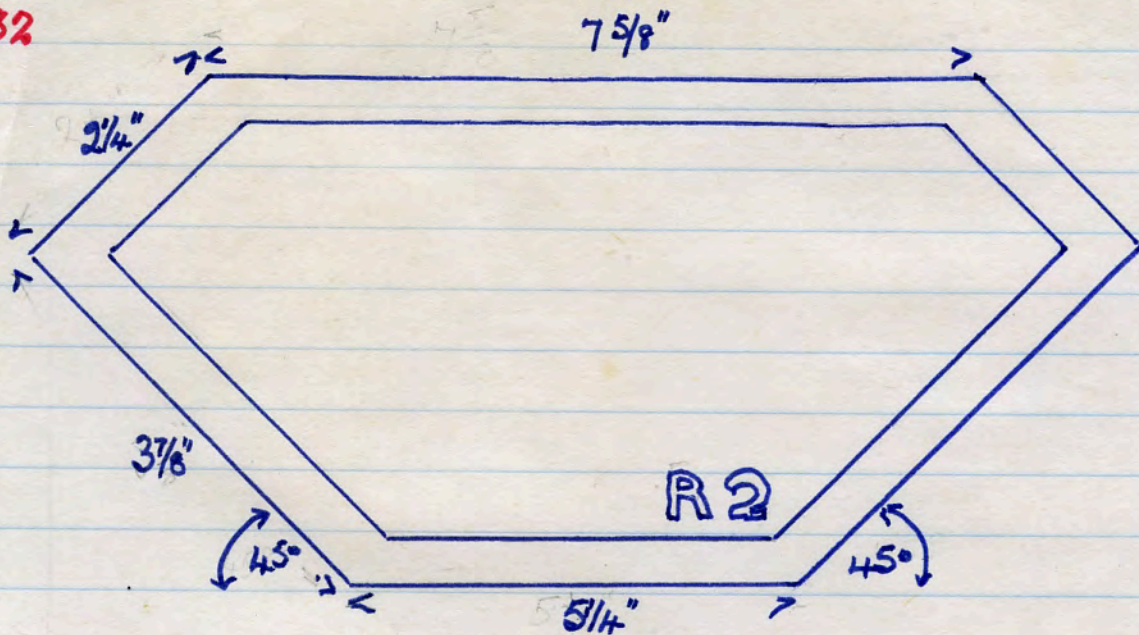

single panel each side R2 stamped one side
Broadfield School dem. site. Rochdale 10. 6. '90

MONK & NEWELL RUABON $2\frac{7}{8}$

good quality brick made from
the marls of Ruabon similar to

4583.

their terra cotta products previously
entered.

7 lbs. 9 " \times $4\frac{5}{16}$ " \times $2\frac{7}{8}$ "
single panel each side
letters clearly incised

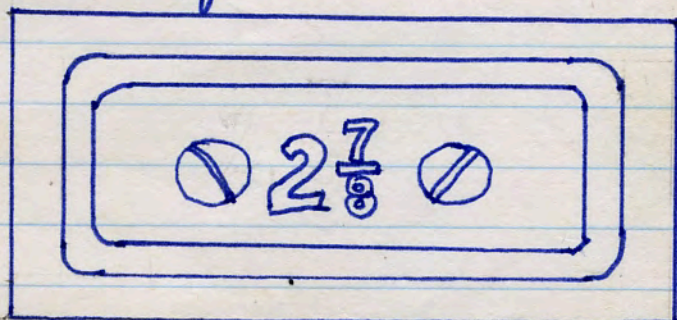

REVERSE

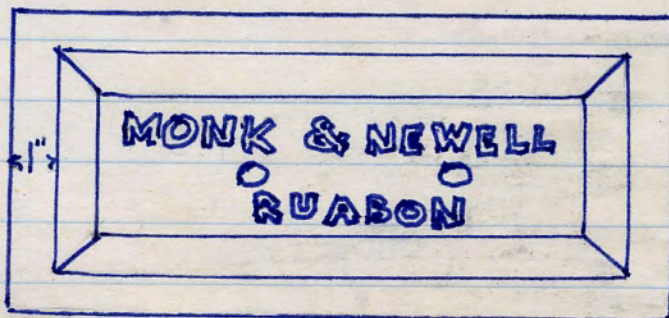

OBVERSE

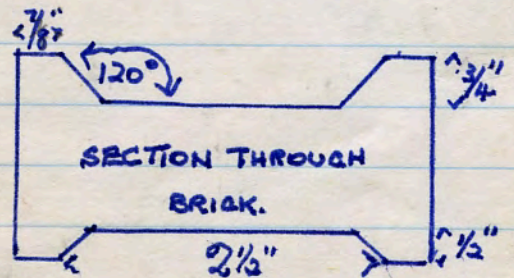

Broadfield School dem. site Rochdale 10. 6. '90

4584

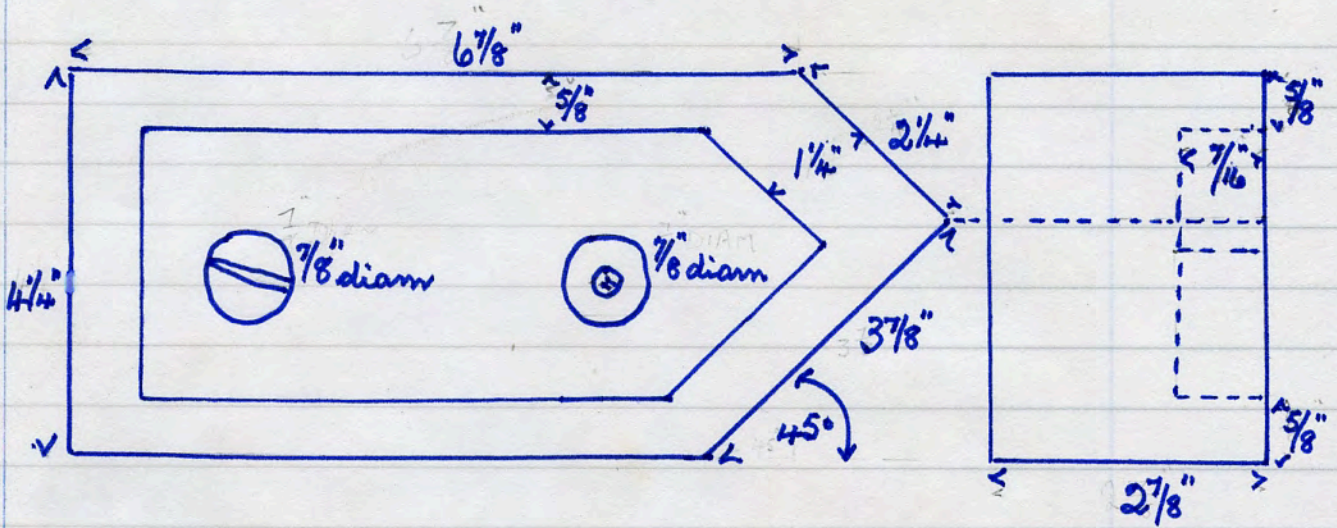

No name. red squint.
 6 lbs. J C stamped on edge.
 single panel each side
 Broadfield School dem. Rochdale. 17. 6. '90

No name. dec. red T.C. jamb. stamped R82
 8 lbs. 1 cavity 3" x 2 1/4"
 Broadfield School dem. Rochdale. 17. 6. '90

4585

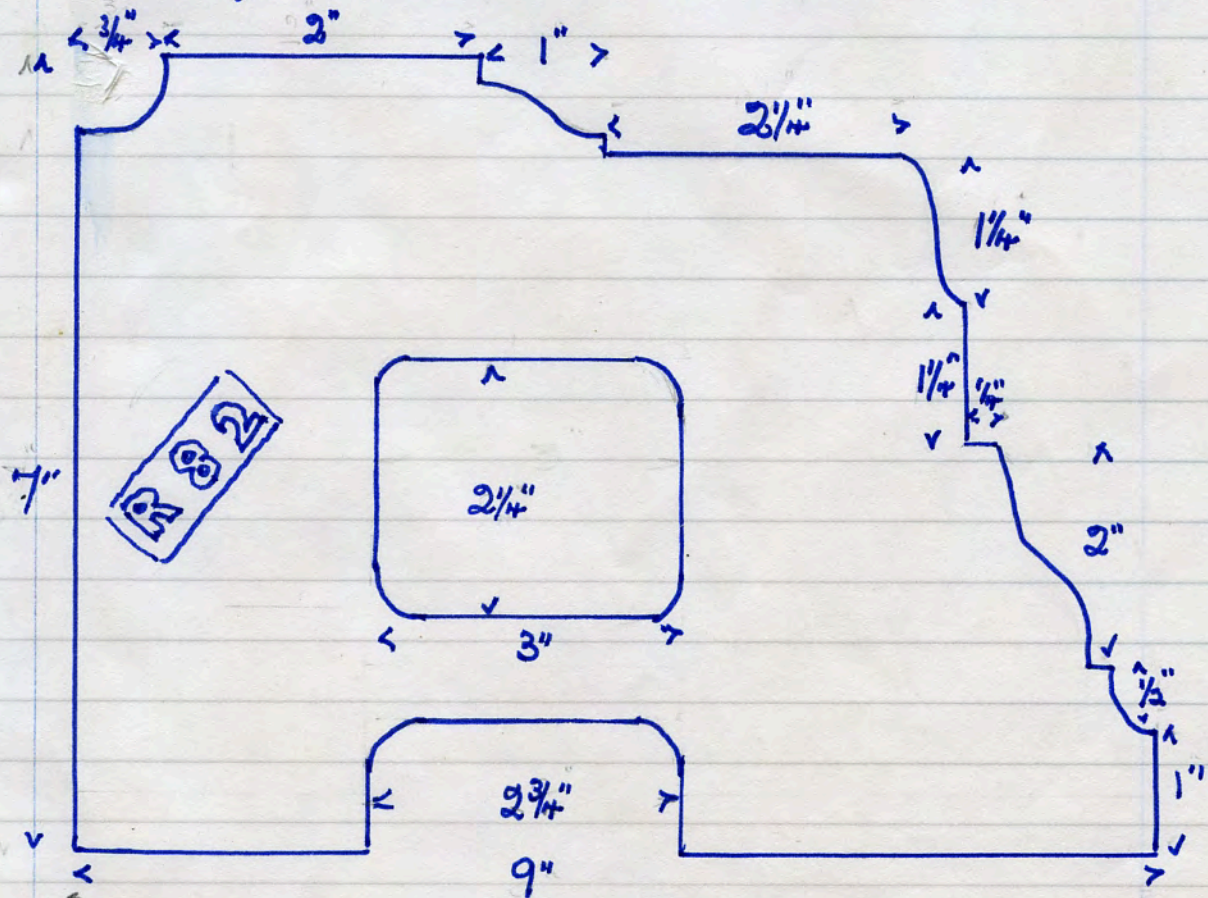

4586 No name (Monk + Hewell) red T.C. section through door casing, for 3 courses of brickwork. mould is similar, horizontal joints are level, not stepped as 4560. CX stamped in rebate. 25 lbs.

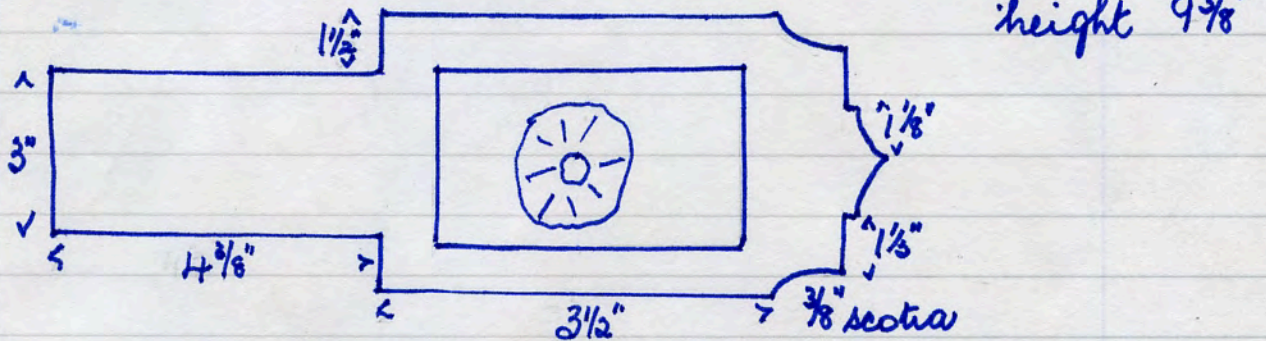

Broadfield School dem. site Rochdale. 17. 6. '90

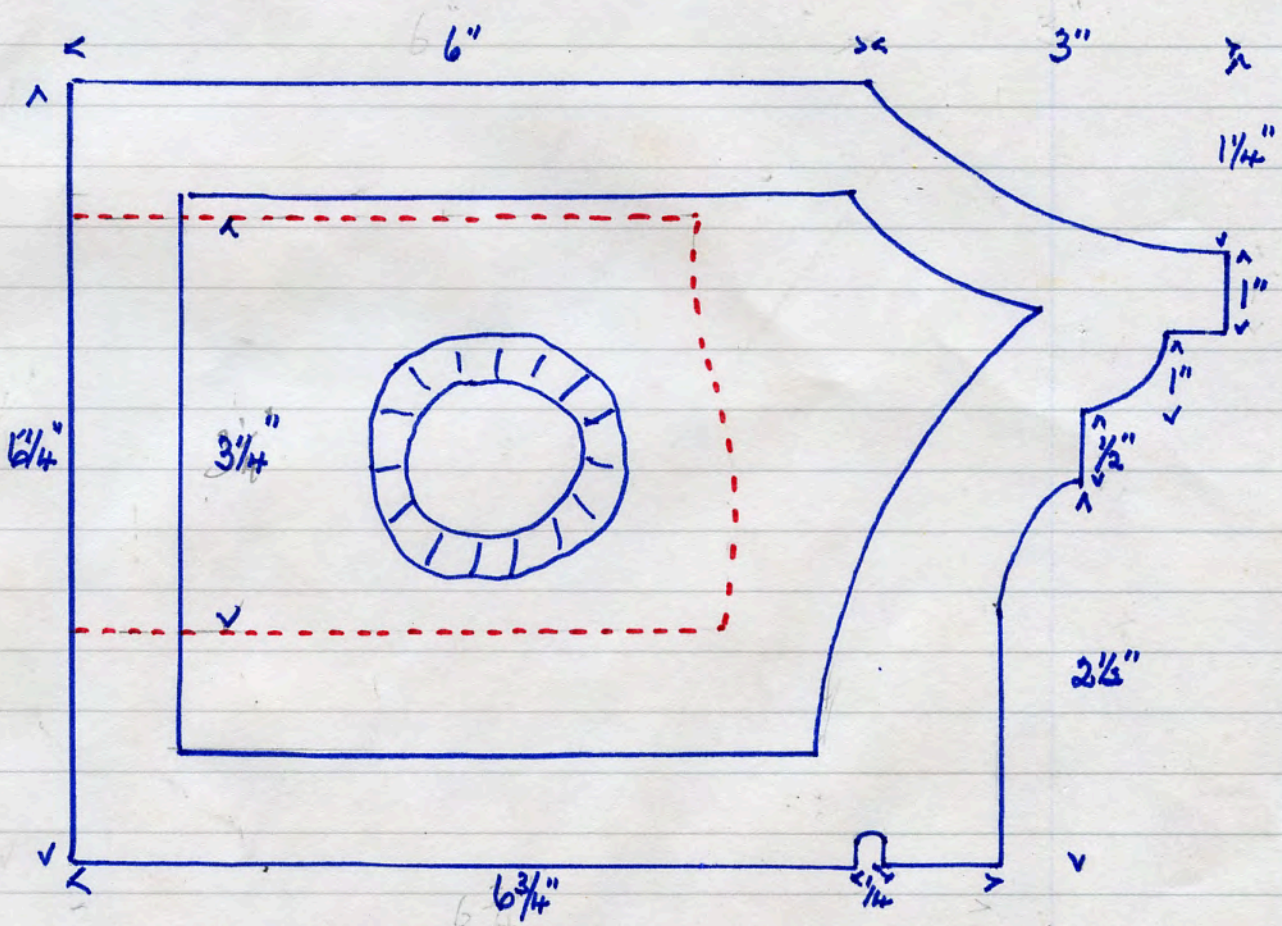

4587 ACCRINGTON NORI BRICK & TILE CO L^{td} red T.C string course 2 lvs.

28 lbs. 2 perms.

letters and BI stamped on base.

Broadfield School dem. site, Rochdale 17. 6. 90.

ACCRINGTON NORI BRICK & TILE CO LF red T.C return of 4587

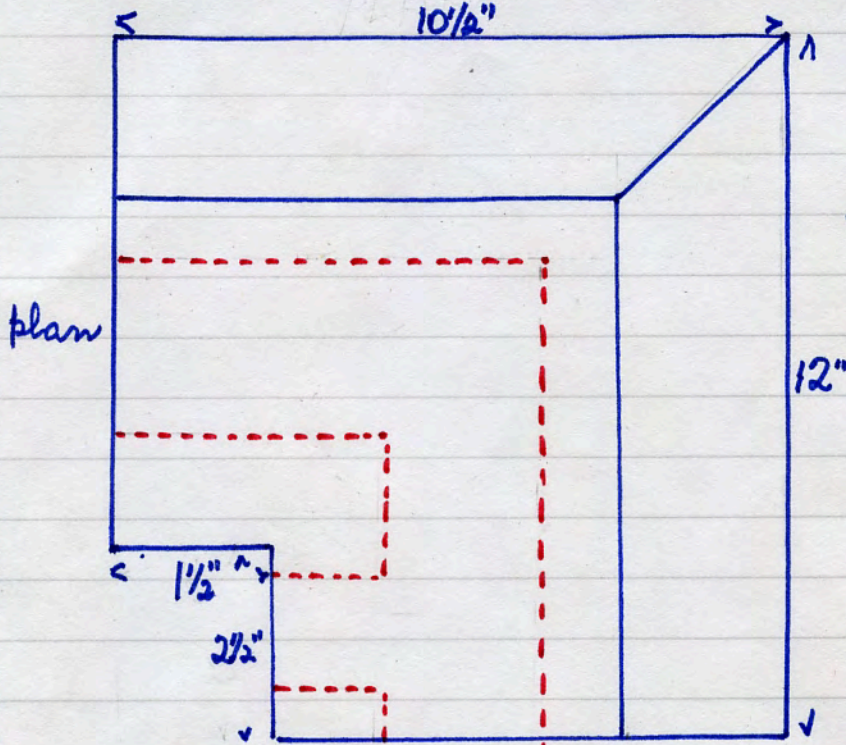

36 lbs.
letters and B4
stamped on base.

4588

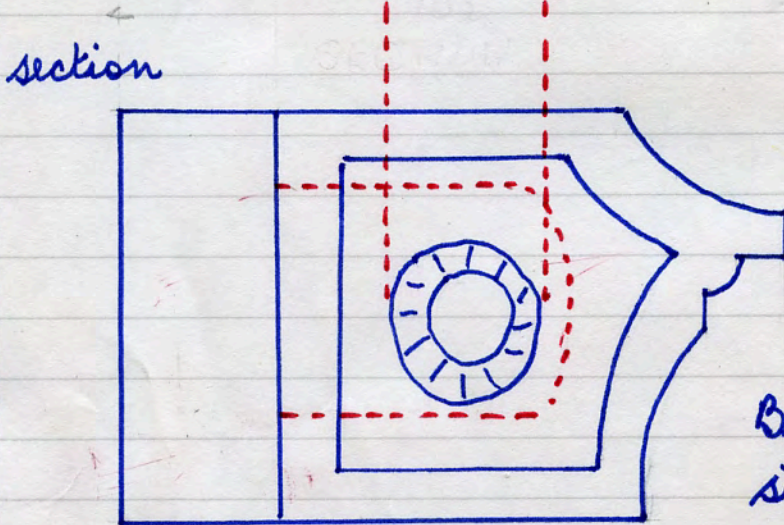

Broadfield School dem.
site, Rochdale. 17. 6. '90

ACCRINGTON NORI BRICK & TILE CO^o LD starter jamb.

10 1/2 lbs. 8 7/8" x 4 1/4" x 3 1/8"

single panel rev. 56 stamped letters stamped obv.

red.

Acc/ton Nori dem. site 20. 5. '90

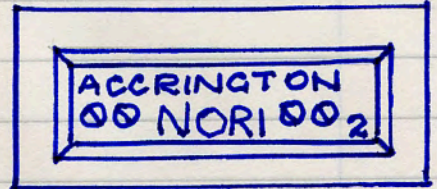
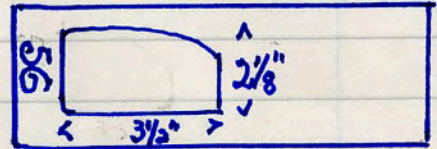
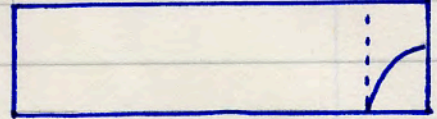
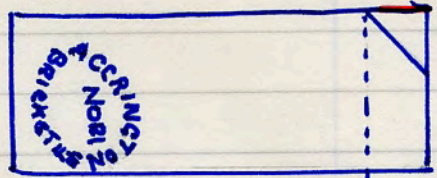

4577

ACCRINGTON NORI 2. red closer

6 3/4 lbs 9 3/16" x 4 1/2" x 2"

single panel obv. only. plain rev letters incised obv. 2 in relief

Acc/ton Nori dem. site 20. 5. '90

5/16" hollow.

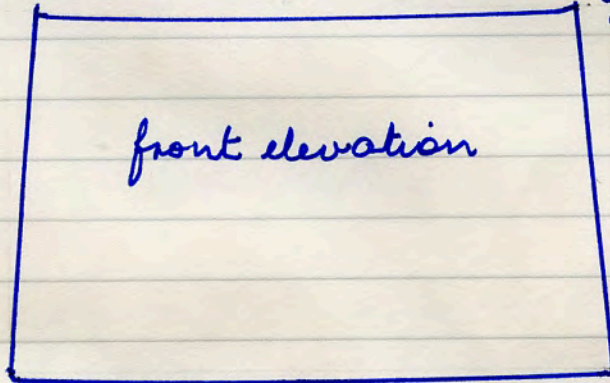

front elevation

4578

4579

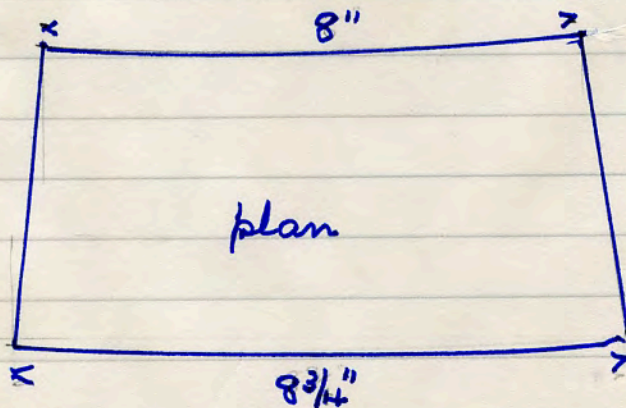

plan

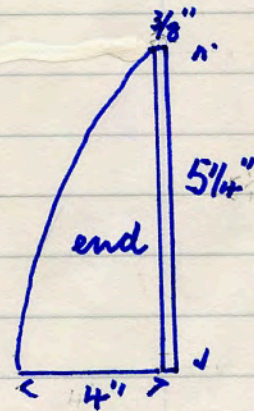

end

No name. 96 C 8 red T.C.

11 lbs 8 3/4" - 8" x 5 3/4" deep. x 4" at base

numbers scribed on base. no panels

Acc/ton Nori dem. site 1. 7. '90

LAUDER & SMITH BARNSTAPLE *nd, part of curved*
6 lbs. 9" x 4³/₁₆" x 3" *string course*

REVERSE

LAUDER & SMITH
BARNSTAPLE

OBVERSE



single panel rev. letters incised. (note M in reverse)
Mrs H. Finlayson, from a cottage in Abbotsham, N. Devon
12. 7. '90 Delivered by Mr J. B. Taylor, Bicester

5000

No. 5,000. Inf. provided by Mr. R. Finlayson, Bideford.

1836 Alexander Lauder 1836 - 1921

Recognised artist and architect before establishing business with brother-in-law, William Smith, to make bricks, tiles and architectural earthenware in 1846.

1846 Developed to produce decorative tiles and ornamental pottery.

1888 Pottington works at Barnstaple named Devon Art Pottery and marked Lauder & Smith.

1889 Smith left business but pottery continued, much to the imitation of J. G. A. Brannan (another local pottery)

1900 Lauder left much of the work to his staff.

1914 Pottery closed.

Lauder was Mayor of Barnstaple 1885 - 1886

Much more data in David & Charles Reprints - published in 1971 of Strong's Industries of North Devon 1889.

Barnstaple Museum.

Plenty of Lauder & Smith, and Lauder pottery, but only one L & S brick, undecorated.

Brannan's Pottery still exists 1991 but not owned by the family.

4589

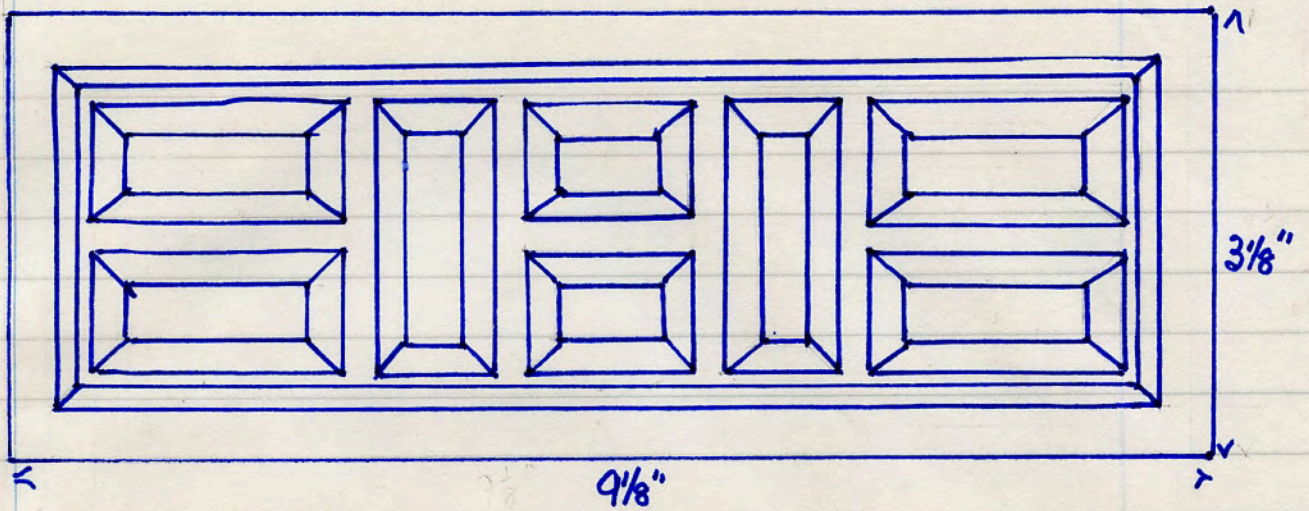

No name. red T.C ventilator brick.

3 lbs. $9\frac{1}{8}'' \times 3\frac{1}{8}'' \times 3\frac{1}{8}''$

Acc/Kon Mori dem. site 20. 5. '90

4590

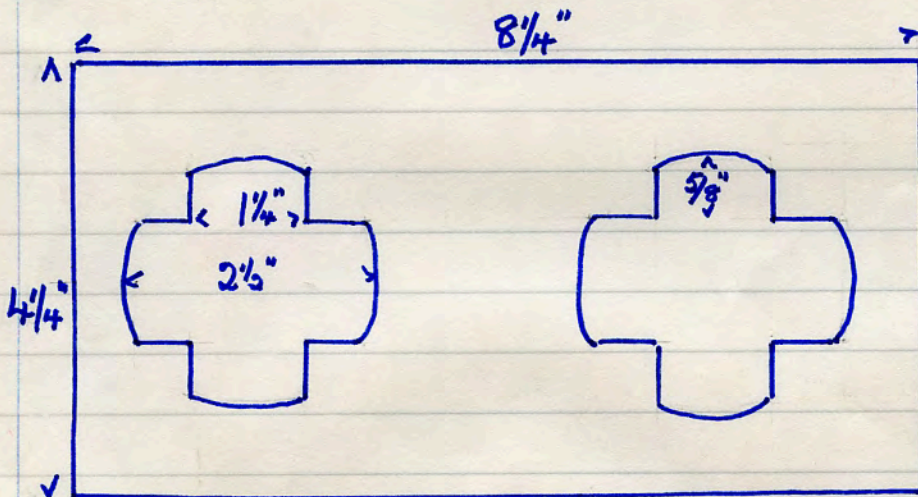

No name.
red T.C block
with 2 perfs.

8 lbs.

$8\frac{1}{4}'' \times 4\frac{1}{4}'' \times 4\frac{5}{8}''$

Acc/Kon Mori dem. site 24. 6. '90

No name. red T.C segment - starting piece for base
of circular conduit - circumference $8\frac{1}{2}$ " - height from
base to shoulder of tongue $5\frac{3}{4}$ ". 31 M1 incised.

5lbs.

4591

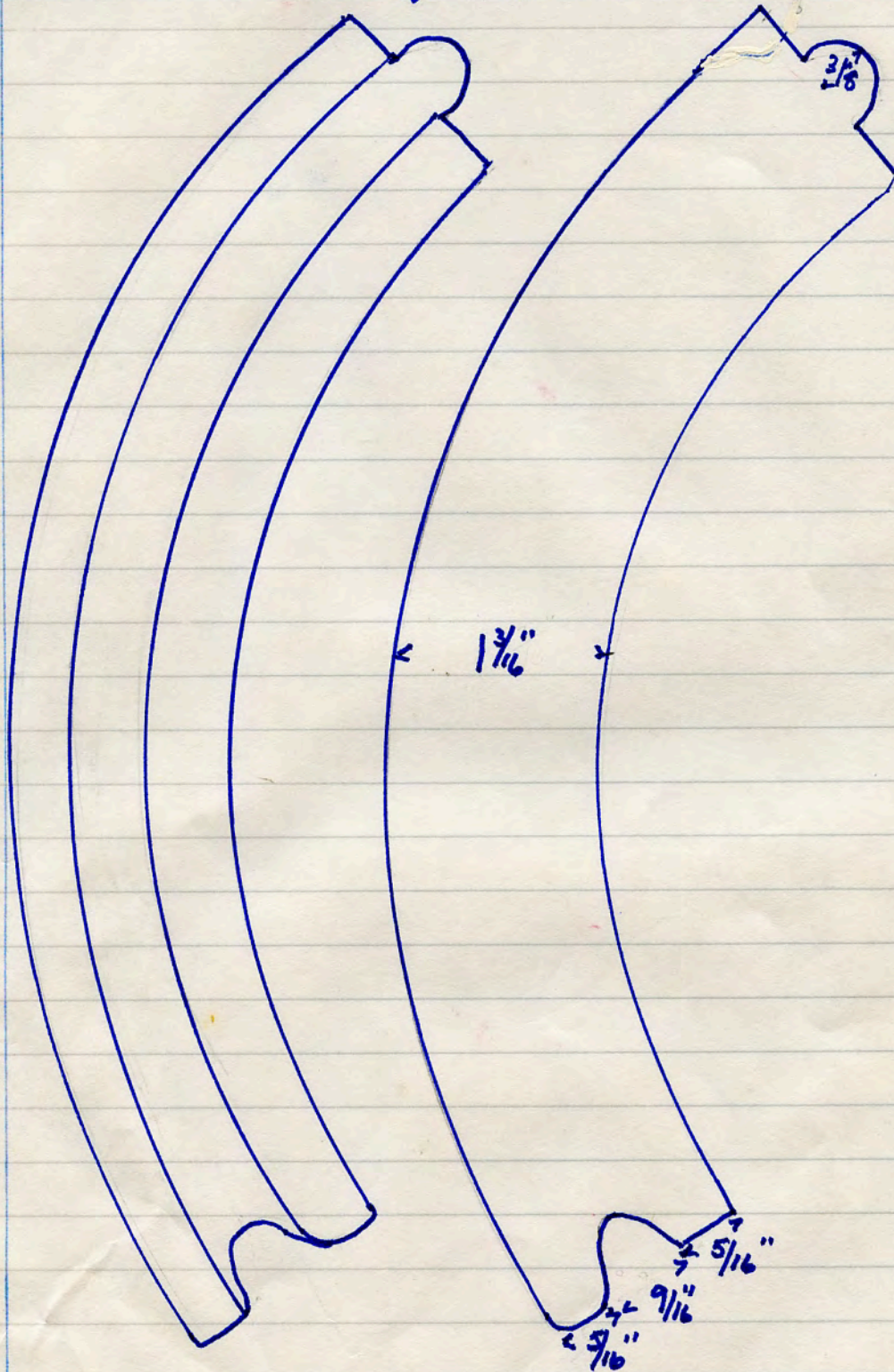

Acq'tion Mori dem. site 24. 6. '90

4592

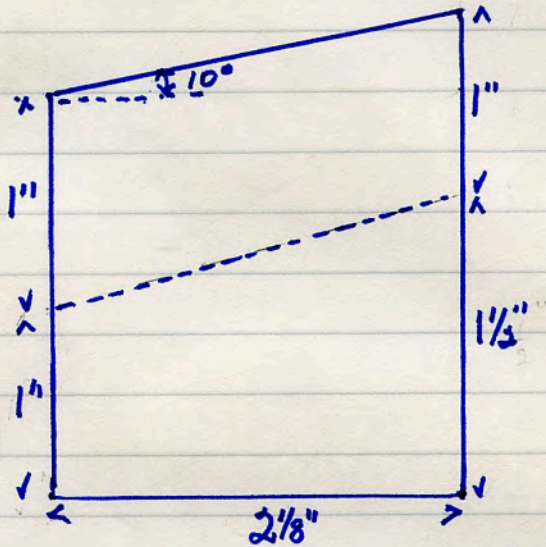
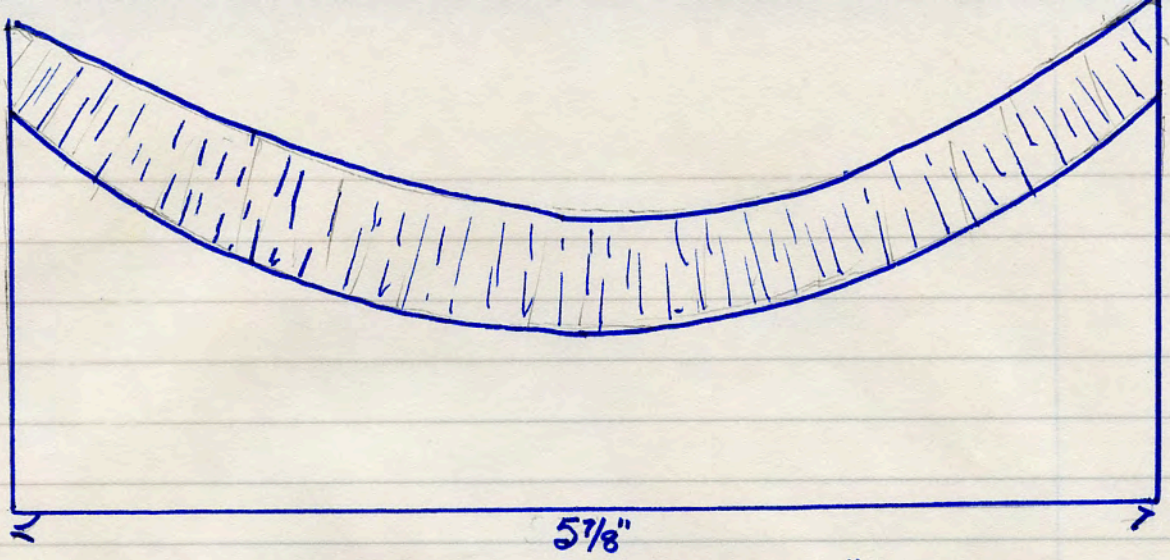

No name red T.C
 27 G 107 stamped
 on base
 107 scraped on end.
 1 1/2 lbs.
 Acc/ton Mori dem.
 site 1. 7. '90.

4593

No name 35T red T.C. 6" x 4 1/8" x 2 3/4" 7 lbs
 nos. stamped on 1 side.

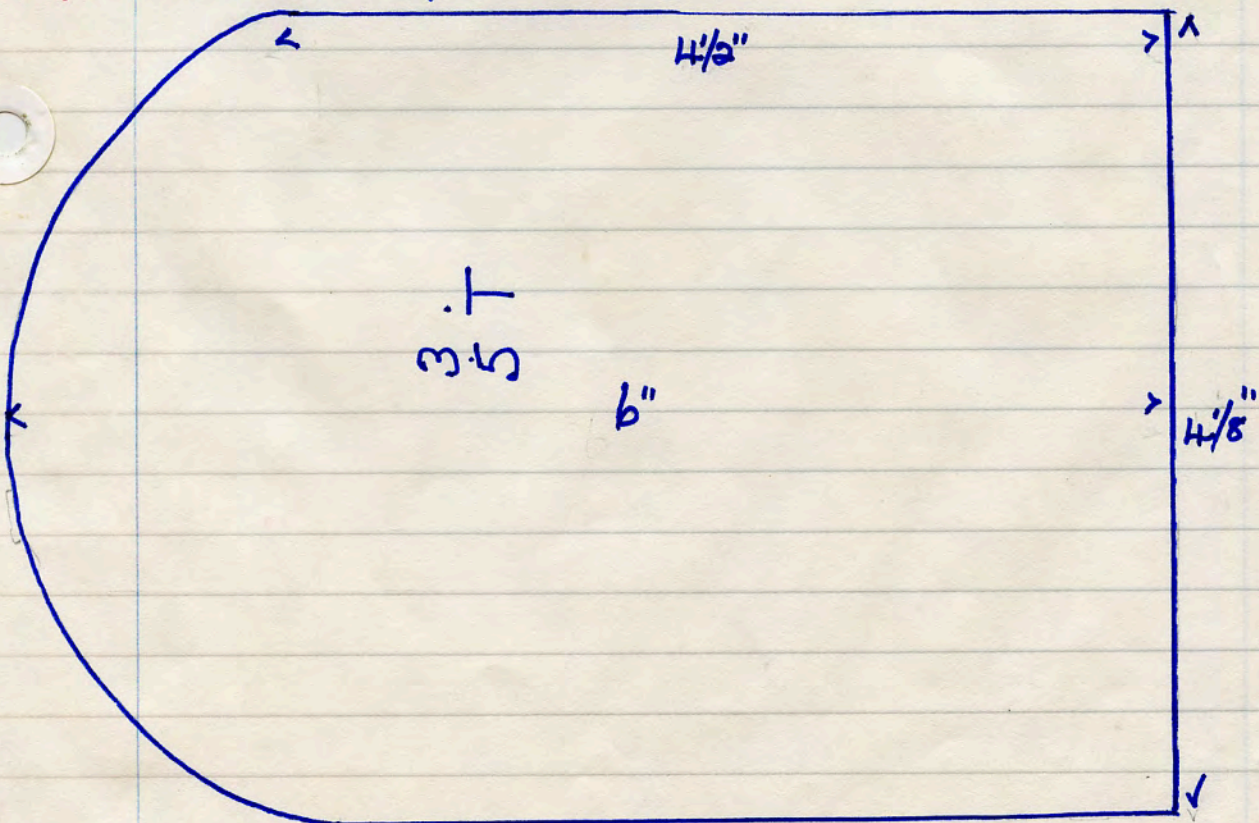

Acc/ton Mori dem. site 1. 7. '90

No name 51 R 1 red T.C. 12 lbs.

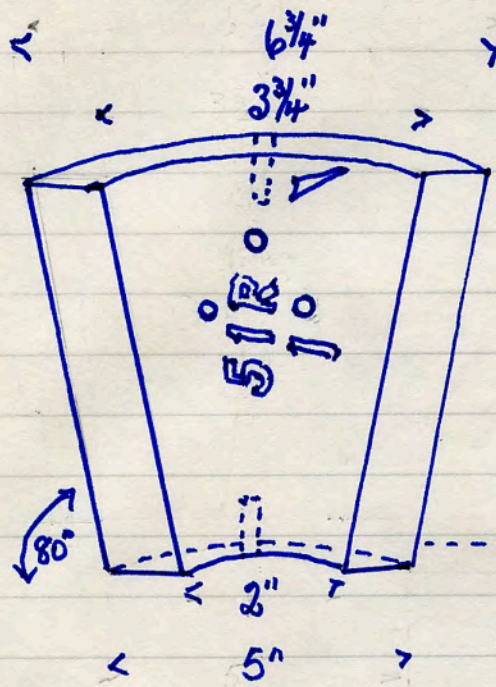

not stamped (deep).
moulder's mark. ✓
all perfs 5/16" diam.

4594

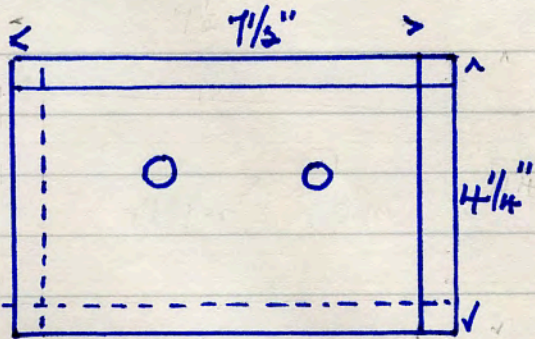

Acc/Kon Mosi dem. site 1. 7. '90

No name. 868 VC red T.C. 13 lbs wire run.
numbers stamped on end. no panels.
Acc/Kon Mosi dem. site 1. 7. '90

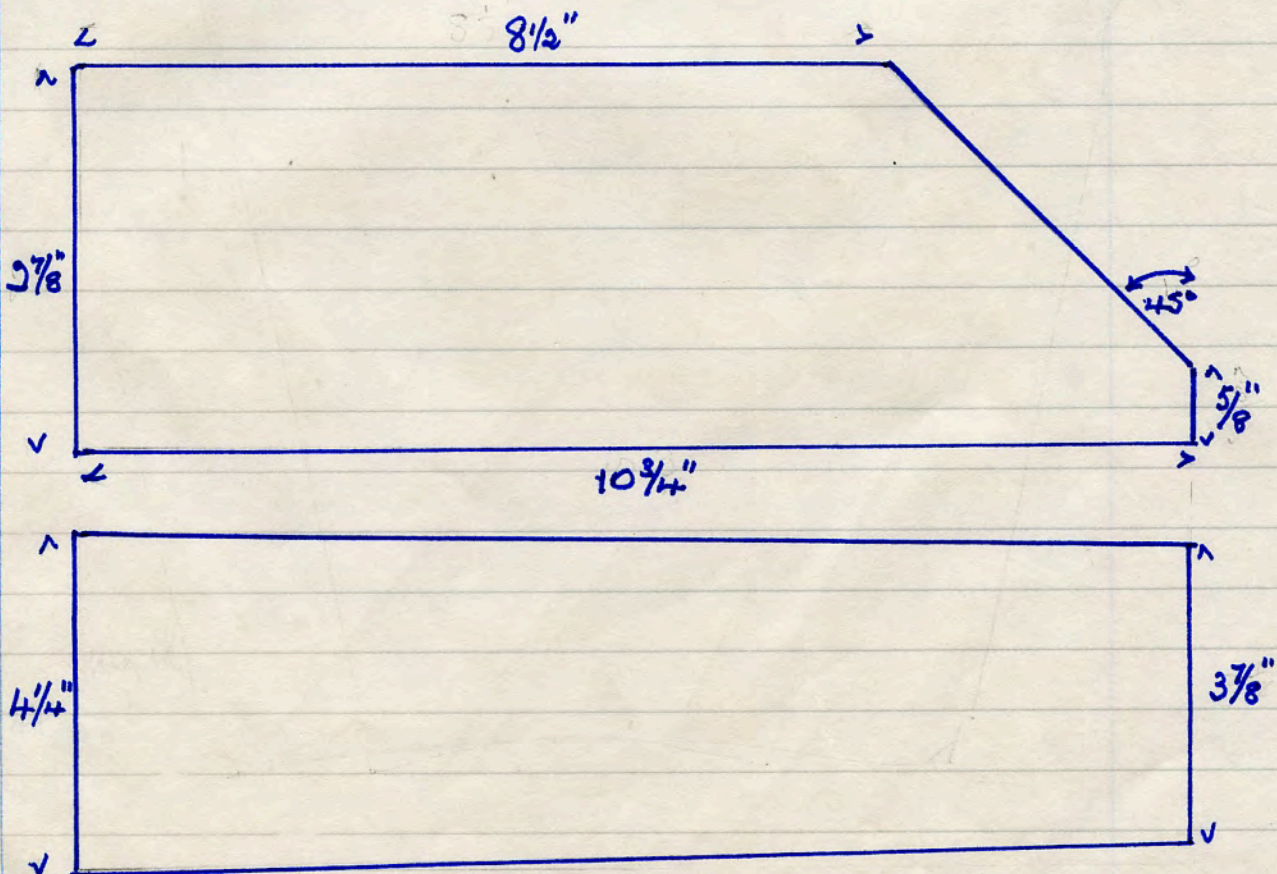

4595

No name. 249 TG 4L Bowland Brown. level return

4596

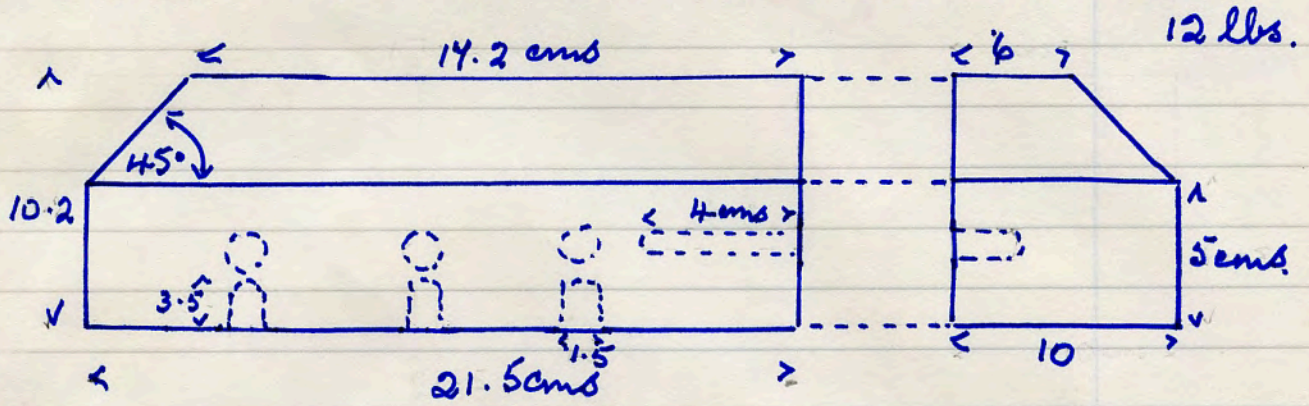

Acpton Mori dem. site 3. 7. '90

No name 27 RUR red T.C. 6lbs right hand.

4597

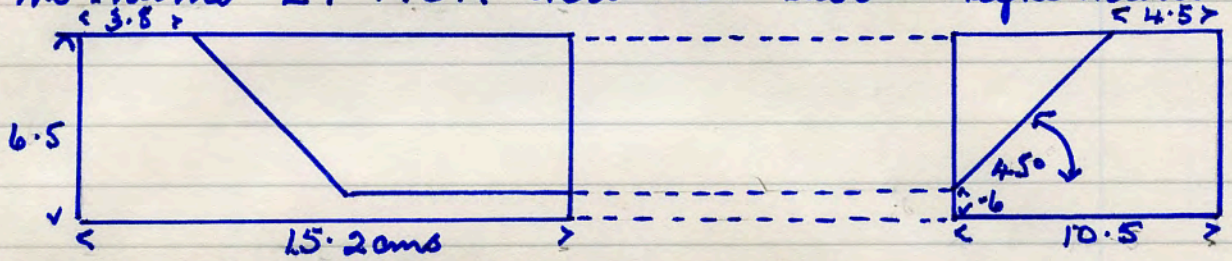

Acpton Mori dem. site 3. 7. '90

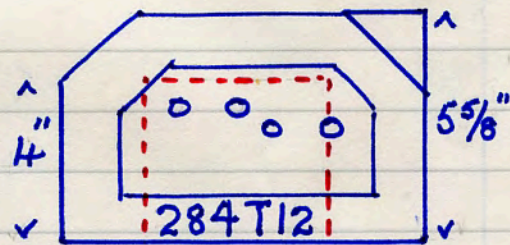
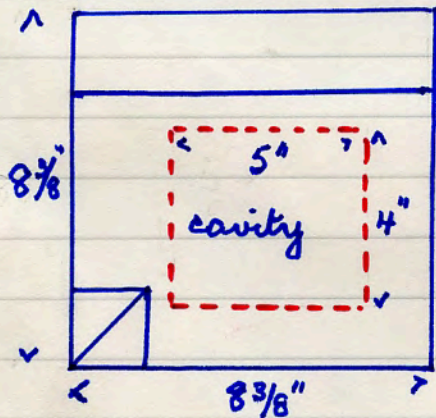

4598

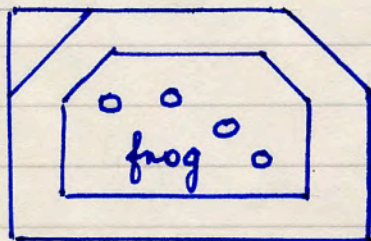

perfs 3/8" diam.
cavity 5" x 4"

27 lbs

No name. 284 T12 red T.C. double splay return
Acpton Mori dem. site. 3. 7. '90

ACCRINGTON NORI red T.C closer. 9 lbs. 9" x 4⁵/₁₆" x 2⁵/₈"

4599

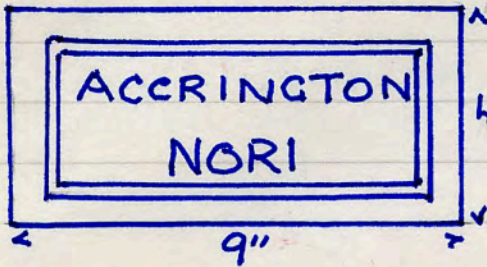

letters incised obv.

dished panel rev.

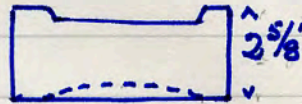

Acc/ton Mori dem. site 3. 7. '90

4600

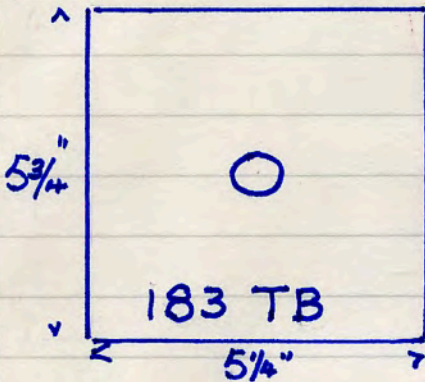

No name 183 TB, red T.C. 7 lbs

1/2" diam. dowel hole.

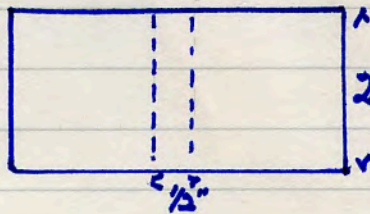

Acc/ton Mori dem. site 3. 7. '90

4601

No name. red T.C bevel fillet 253 2J 7 lbs.

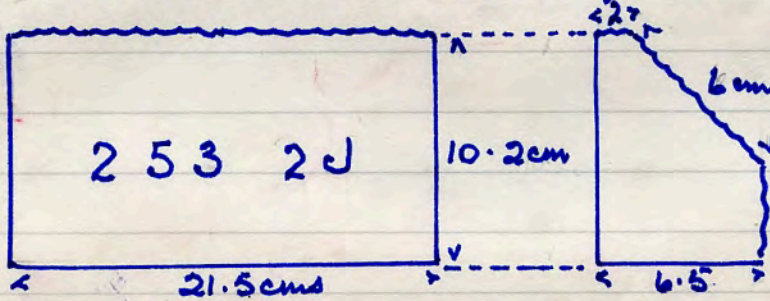

exceedingly rough rustic finish on face edges only.

Acc/ton Mori dem. site 3. 7. '90

ACCRINGTON NORI ACCRINGTON red T.C floor tile DM stamped on edge, letters incised rev.

4602

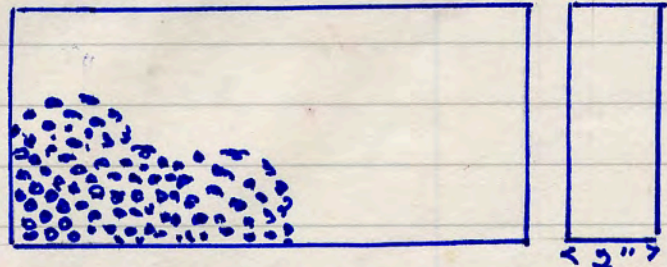
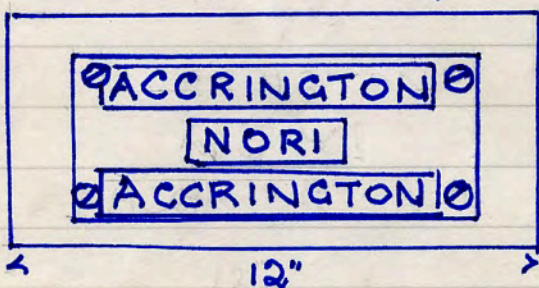

dimpled finish, cockleshell pattern face side. 14 lbs
Acc/ton Mori dem. site 3. 7. '90

No name 96 G 23. red T.C. 2 1/2 lbs. 2 can be used for a pair of closers.

4603

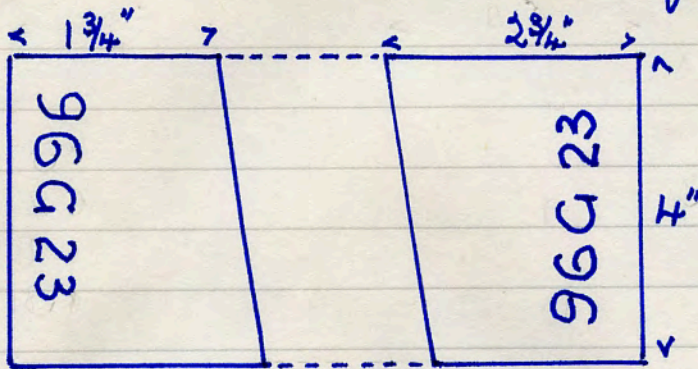

Acc/ton Mori
dem. site 3. 7. '90

4604

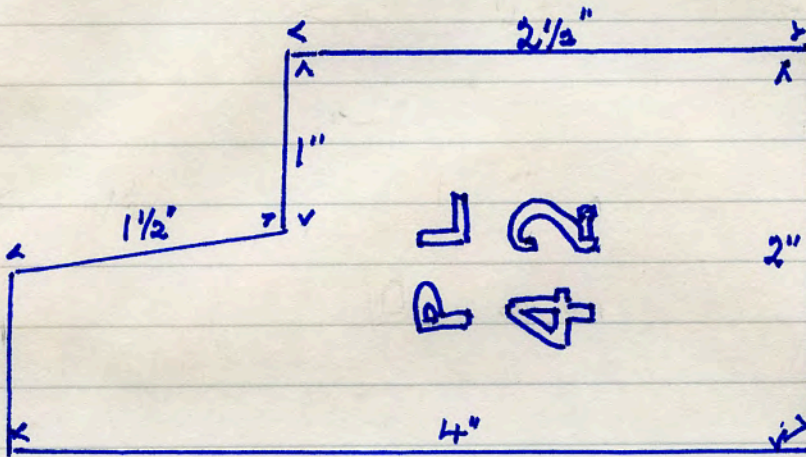

No name. PL42
red T.C. 3 lbs.
letters stamped
actual size.
Acc/ton Mori
dem. site. 3. 7. '90

No name 5L red T.C jamb brick 8 lbs.
5L stamped on base.

4605

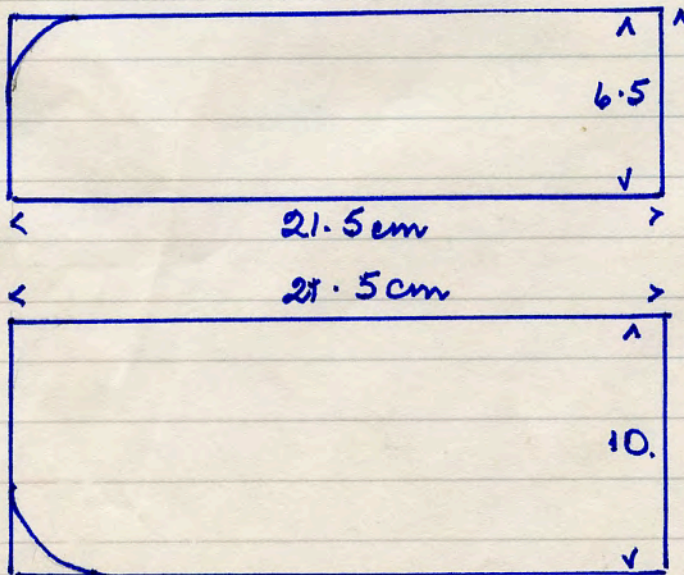

Acc/ton Mori dem.
site 3. 7. '90.

No name. 937 ZL red T.C 9 lbs. numbers stamped

4606

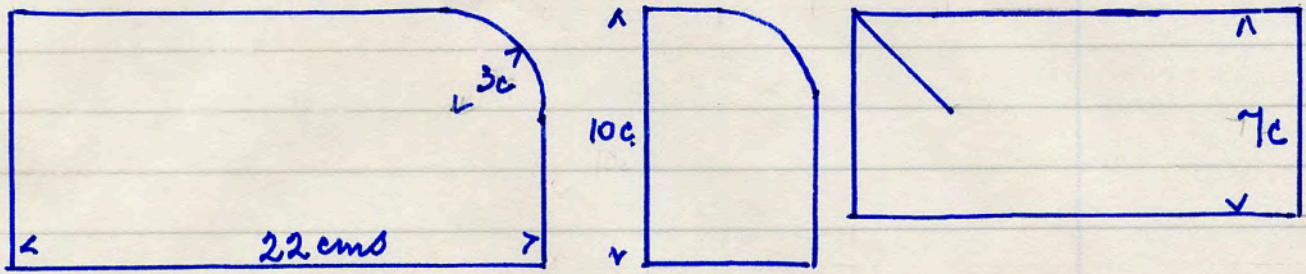

Acc/ton Mori dem. site 4. 7. '90

No name 78K 19X red T.C. 4 lbs. T.C

4607

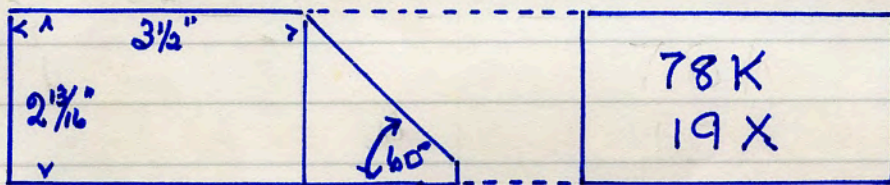
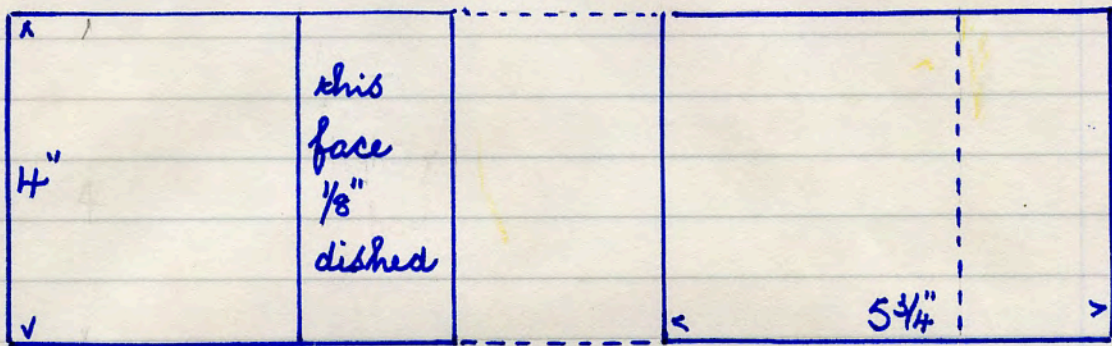

Acc/ton Mori dem. site 4. 7. '90

No name. 2584 RC Bowland Brown. 6 lbs. dog leg with chamfer. right hand

4608

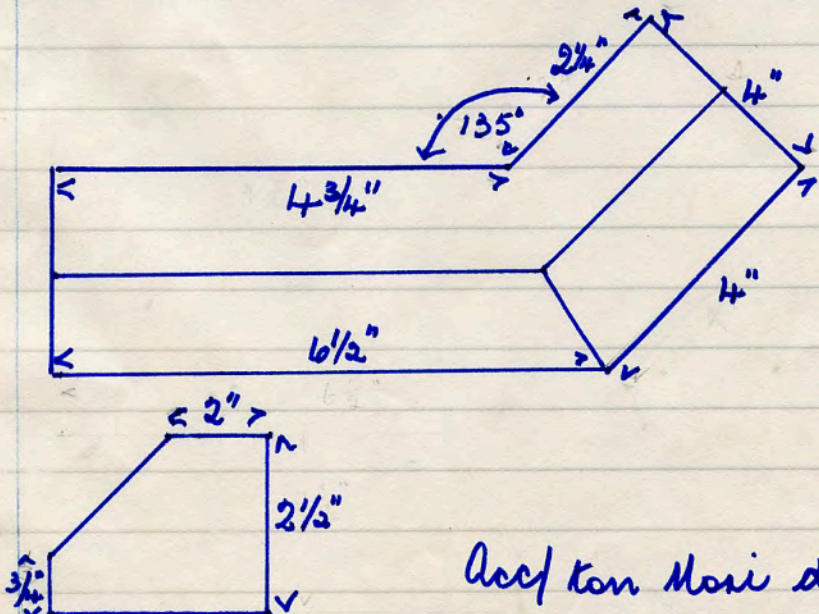

Acc/ton Mori dem. site 4. 7. '90

4609

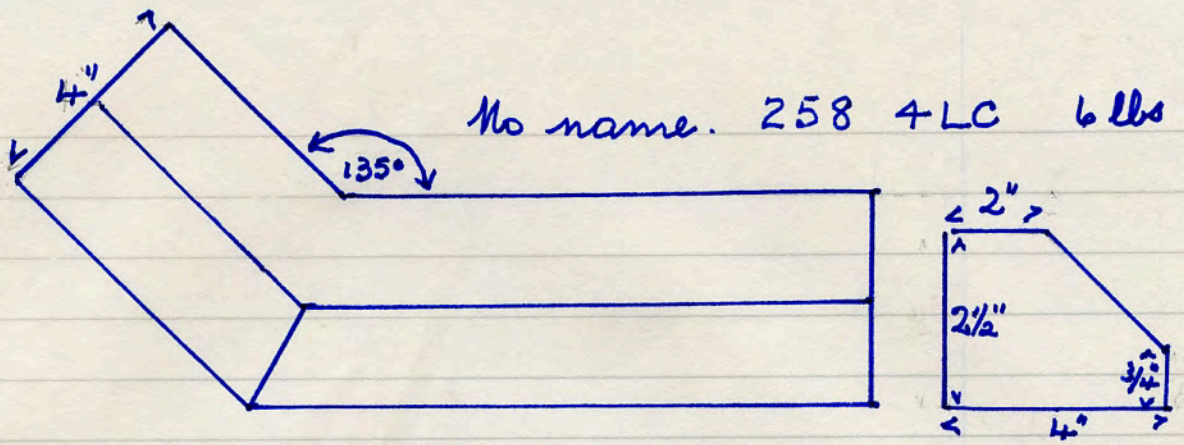

Bowland Brown dog leg with chamfer, left hand
 similar specifications to 4608.

Acc/ton Mori dem. site H. 7. '90

No name. 2 AINTL red T.C internal splayed return
 left hand. water break on rev. 10 lbs.
 moulder's stamp HB

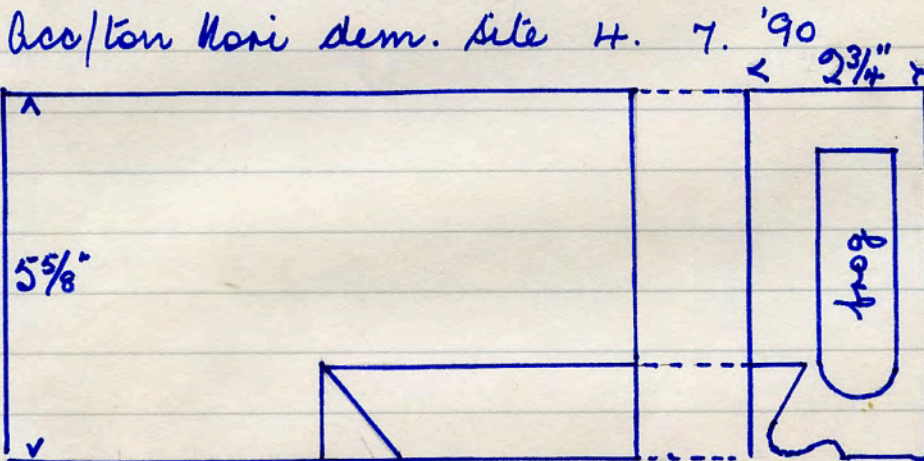

4610

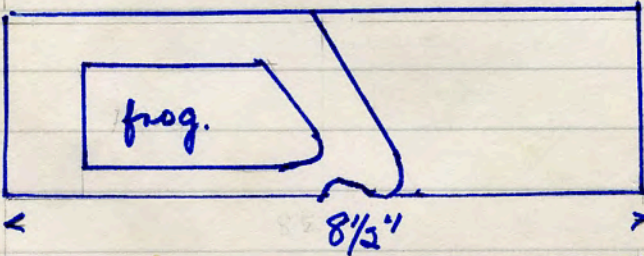

No name. 2 AINTR

repeat of above but
 4611 is right hand.

4611

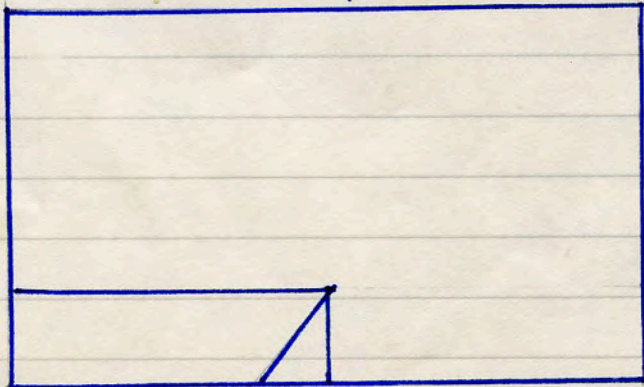

Acc/ton Mori dem. site
 H. 7. '90

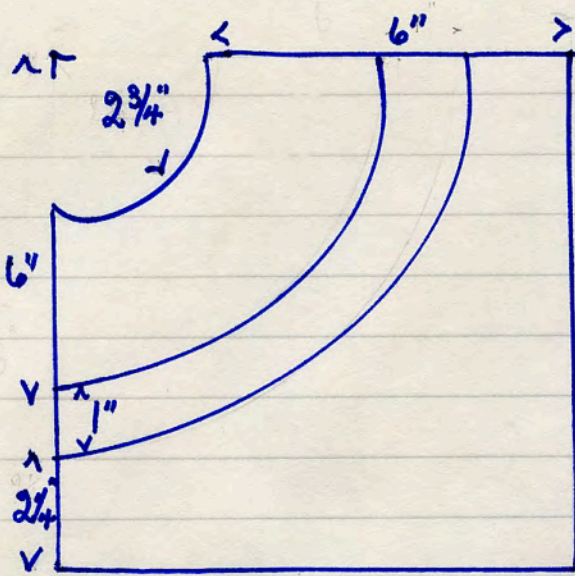

no name 51 L 73 red T.C.
 25 lbs
 1/4 section of circular vessel
 top diam. 7 1/2"
 bottom " 6"

4612

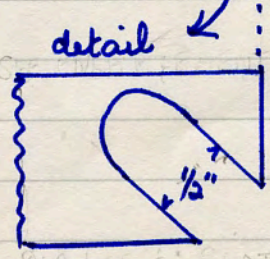
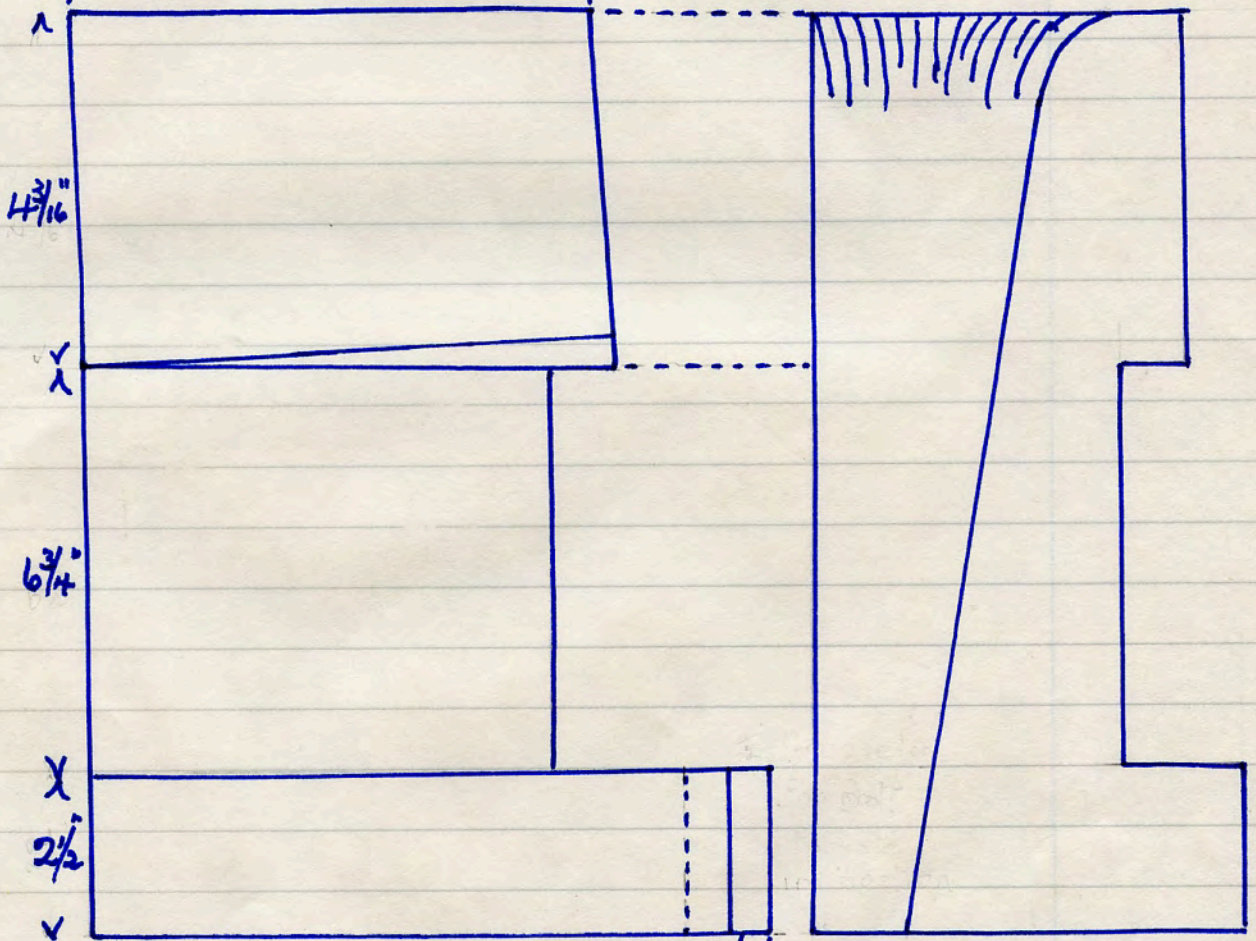

1/2" slot in base to secure.

Acceptor Mori dem. site 5. 7. '90

No name. 89AV RT red T.C. 6 1/2 lbs
 Accpton Mori dem. site 5. 7. '90

H613

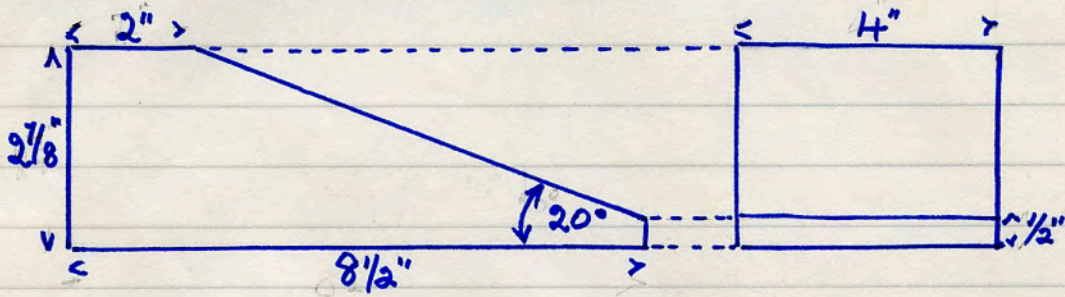

No name. 191 T red T.C. 3 lbs.
 Accpton Mori dem. site 5. 7. '90.

H614

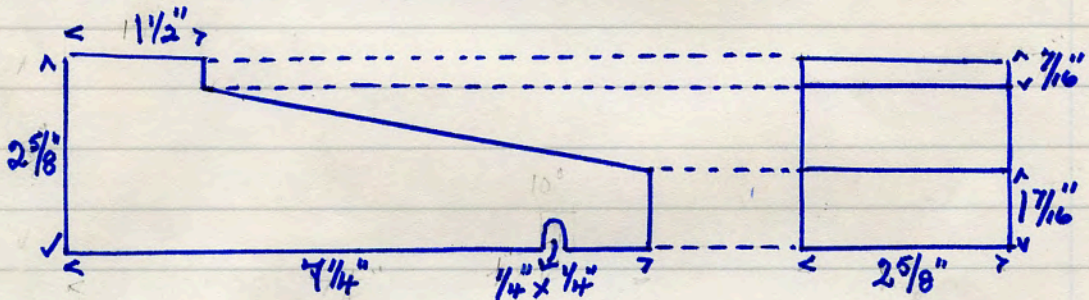

H615

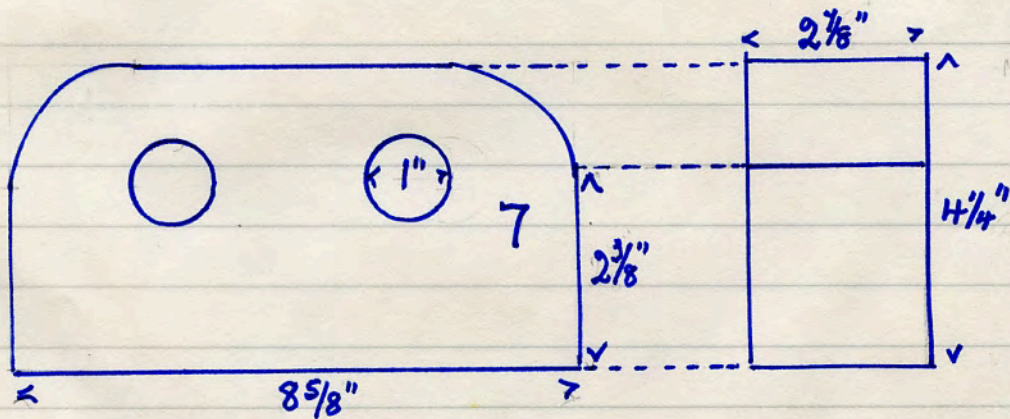

No name 7. red T.C double bull nose wall cap
 7 1/2 lbs 2 x 1" diam. perfs.
 Accpton Mori dem. site 5. 7. '90

No name 23112 RL red T.C

left hand 7 lbs.

Accl'ton Mori dem. site 5. 7. '90

4616

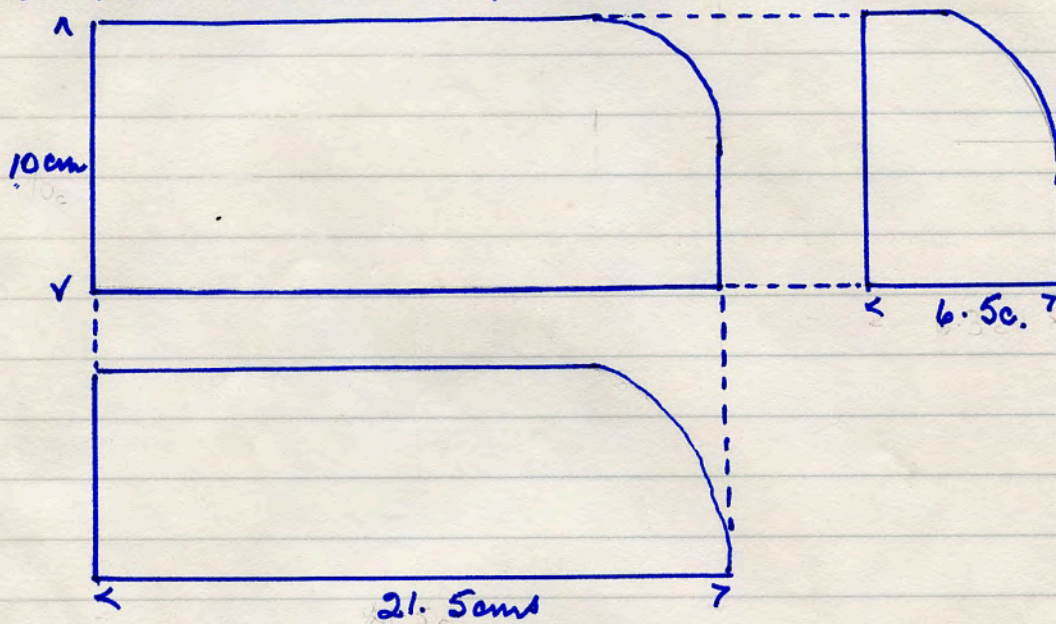

No name 790 UAR Bowland Brown

right hand 7 lbs.

4617

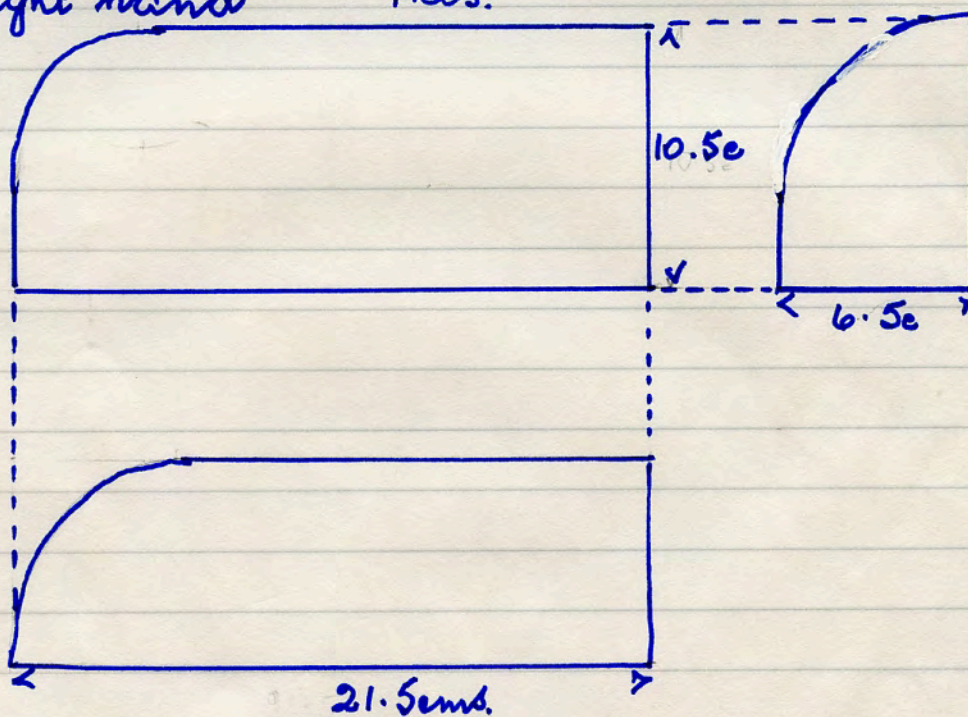

Accl'ton Mori dem. site 5. 7. '90

No name. 2441 dec. red T.C bird mouth 7 1/2 lbs.
 Acc/ton Mori dem. site 5. 7. '90

4618

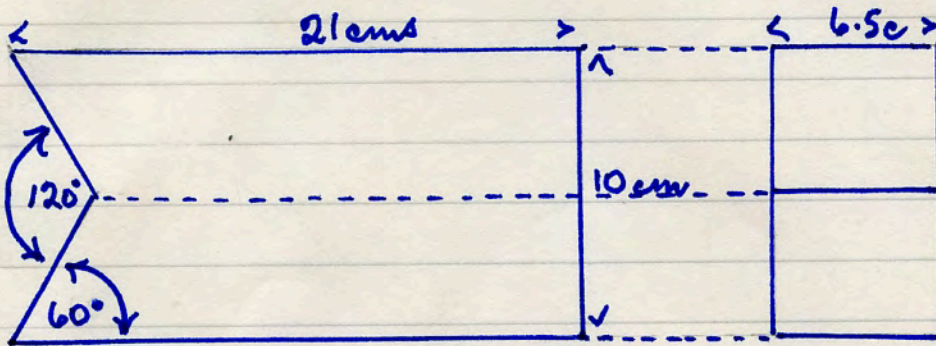

No name. 15 red T.C. 14 lbs length 22 cm
 1 x 1.2 cm perf.
 Acc/ton Mori dem. site 5. 7. '90

4619

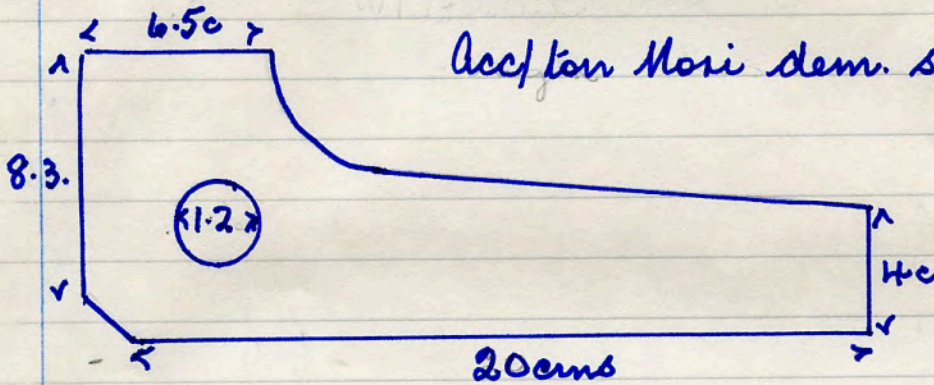

No name. no number. red T.C. semi circular
 wall coping 7 lbs 2 x 2 cm diam. perfs

4620

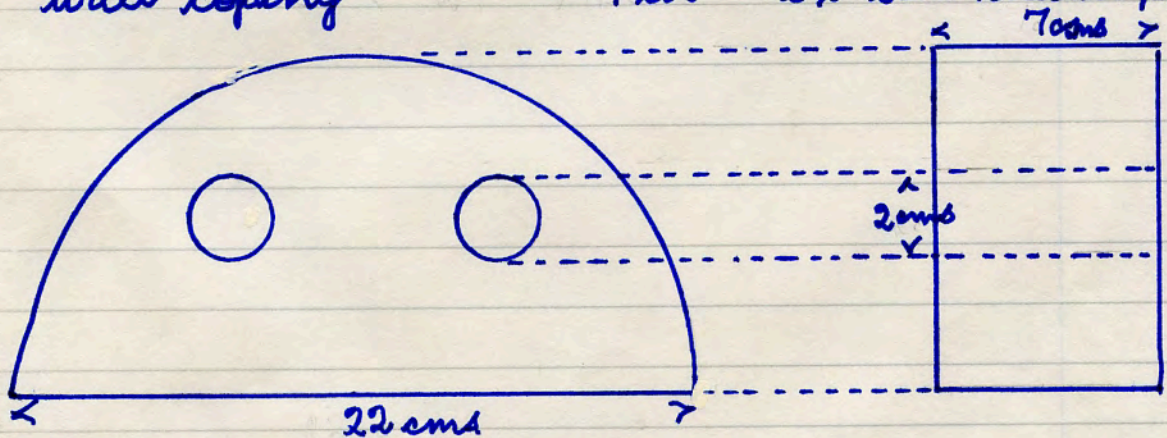

Acc/ton Mori dem. site 5. 7. '90

No name. 39 RJ. red T.C. part of circular ring.
6 lbs.

4624

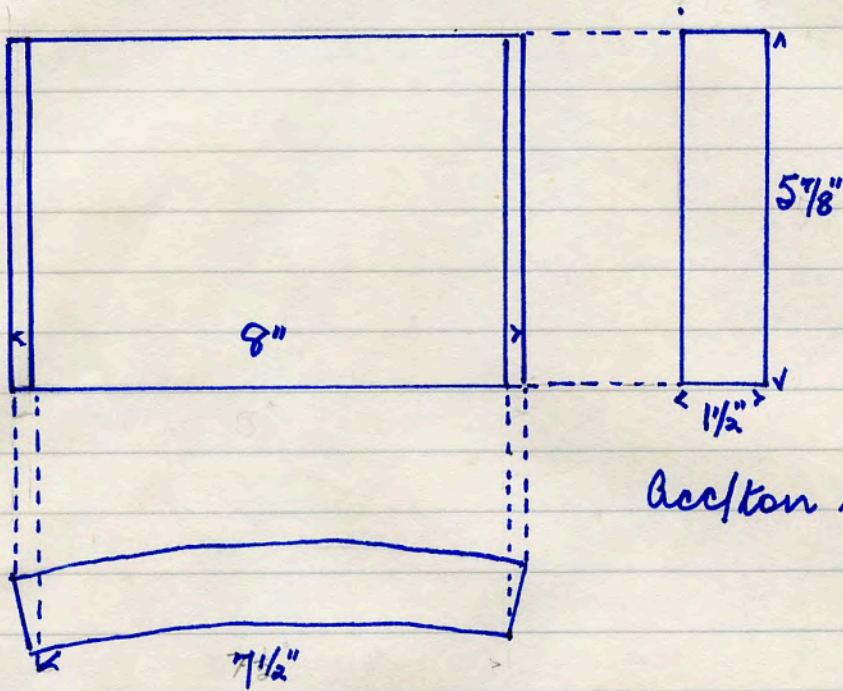

Acfton Mori dem. site
5. 7. '90

No name. 25 M11. red T.C. part of circular ring
with T & G joints
8 1/2 lbs.

4625

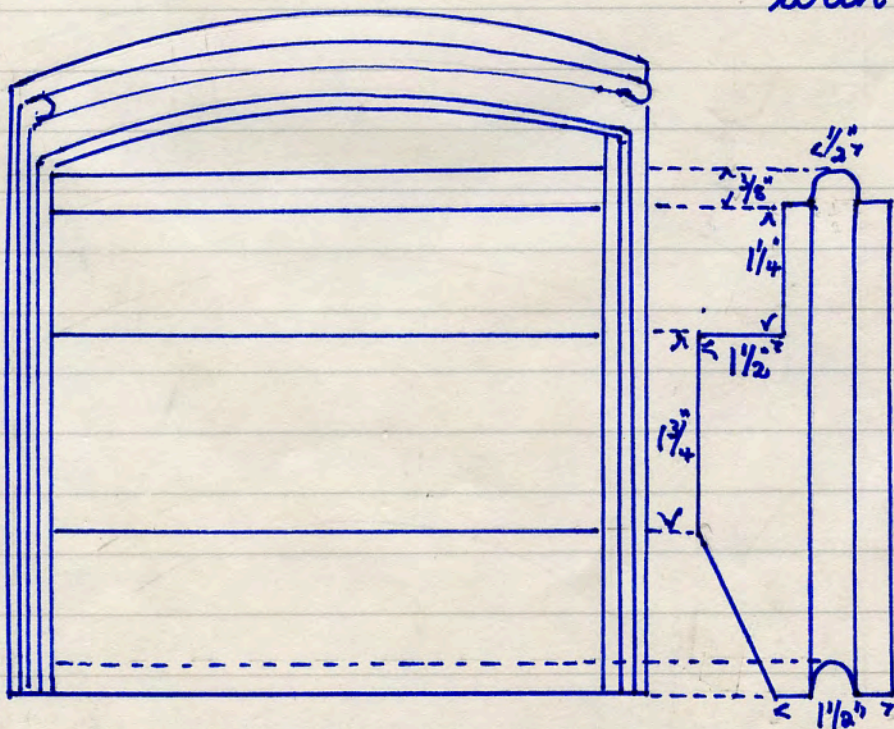

Acfton Mori dem. site 5. 7. '90

No name 335 W 11. red T.C. 7 1/2 lbs.
 Occlton Mori dem. site 5. 7. '90

4621

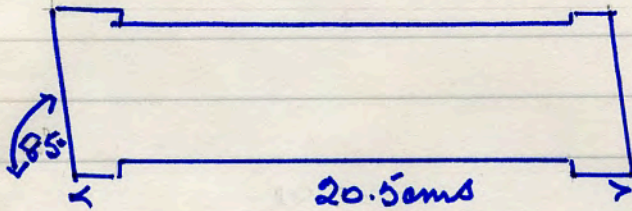
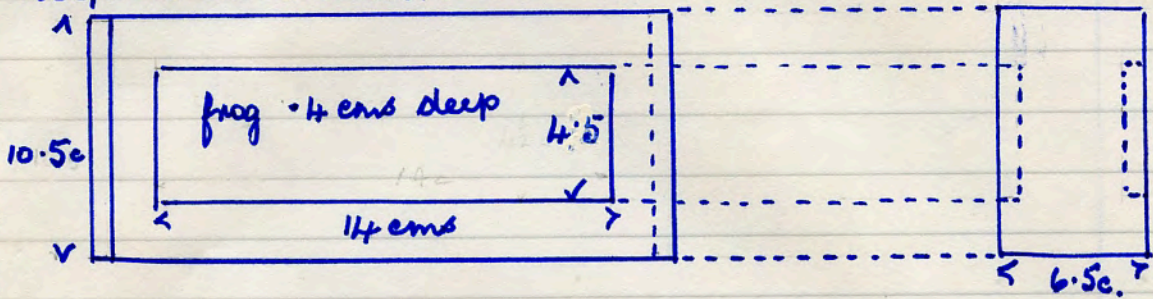

20.5 cm x 10.5 x 4.5

No name. 212. Bowland Brown cill piece or wall

capping
7 lbs.

4622

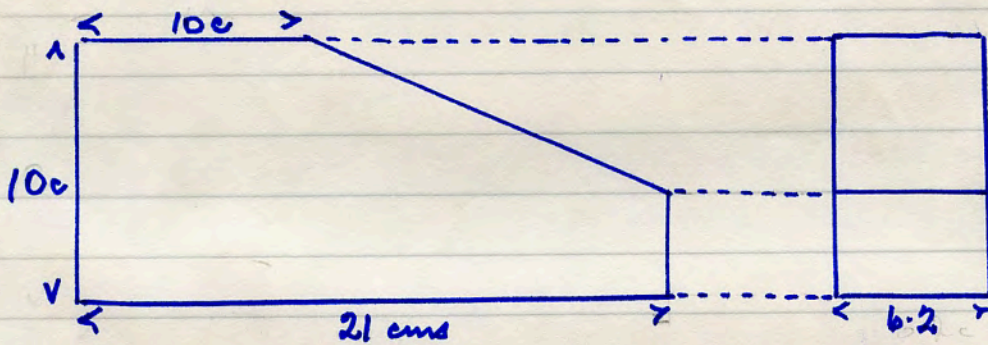

Occlton Mori dem. site 5. 7. '90

9 1/2 lbs.

No name. no number. red kiln support 7 7/8" diam.

4623

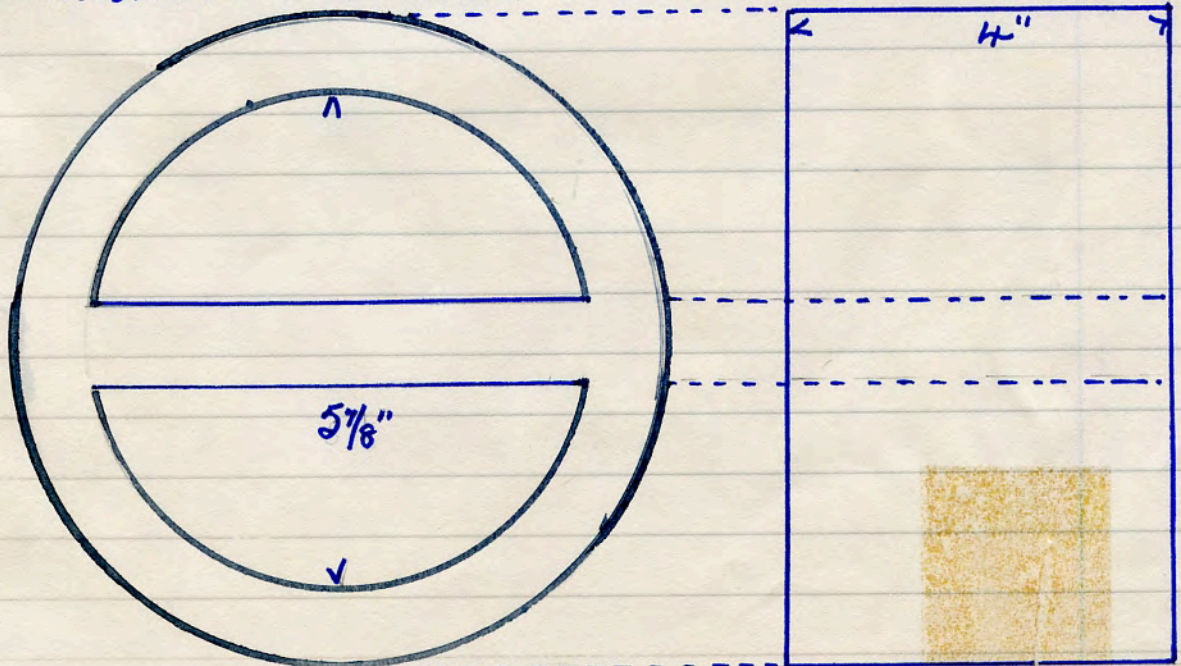

No name 25 M8 red T.C. 7 lbs.
 this member fixes on to No H625

H626

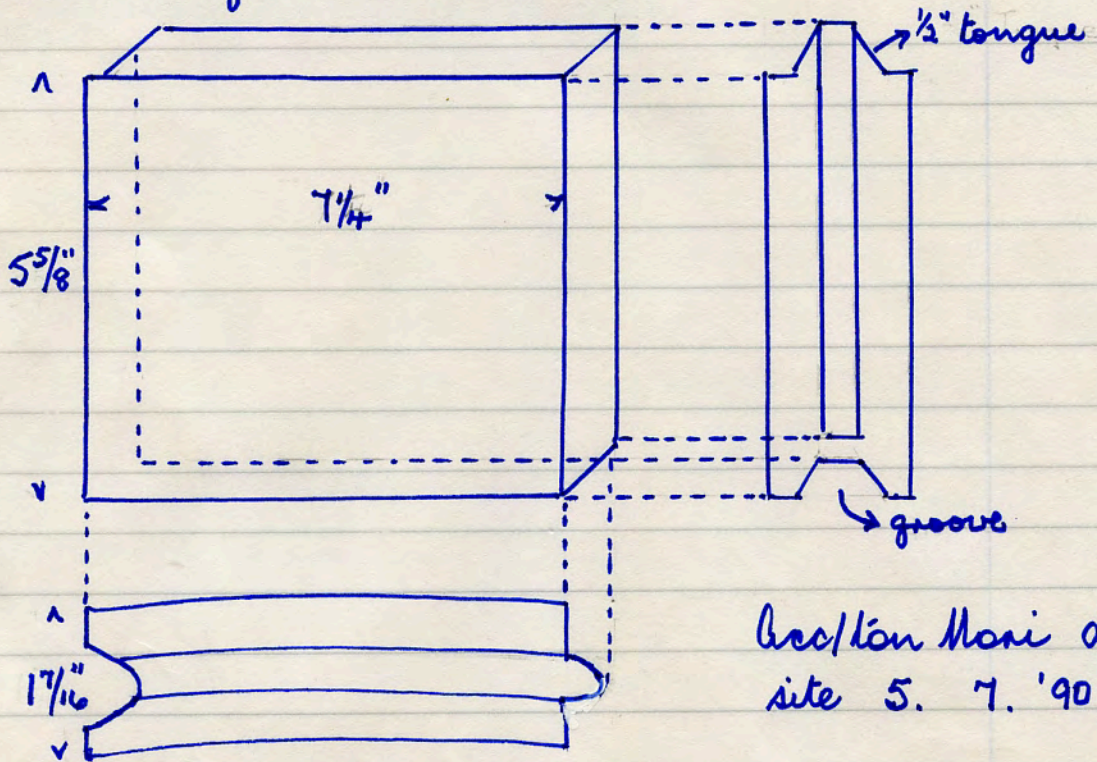

Asclon Mori dem.
 site 5. 7. '90

No name. 371 W 164 red T.C. 5 lbs.
 Asclon Mori dem. site 5. 7. '90

H627

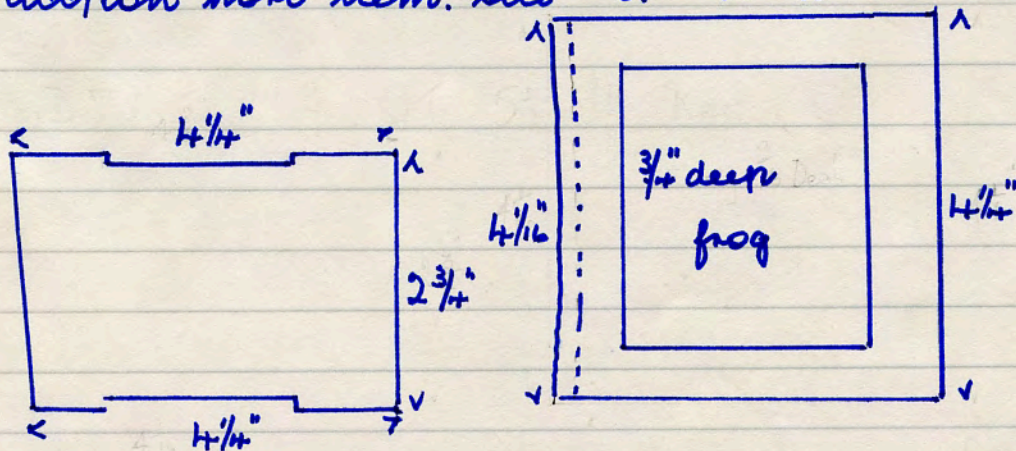

No name 43 L 68 red 2 face edges 1 face side T.C
moulder's marks. JI.
14 lbs.

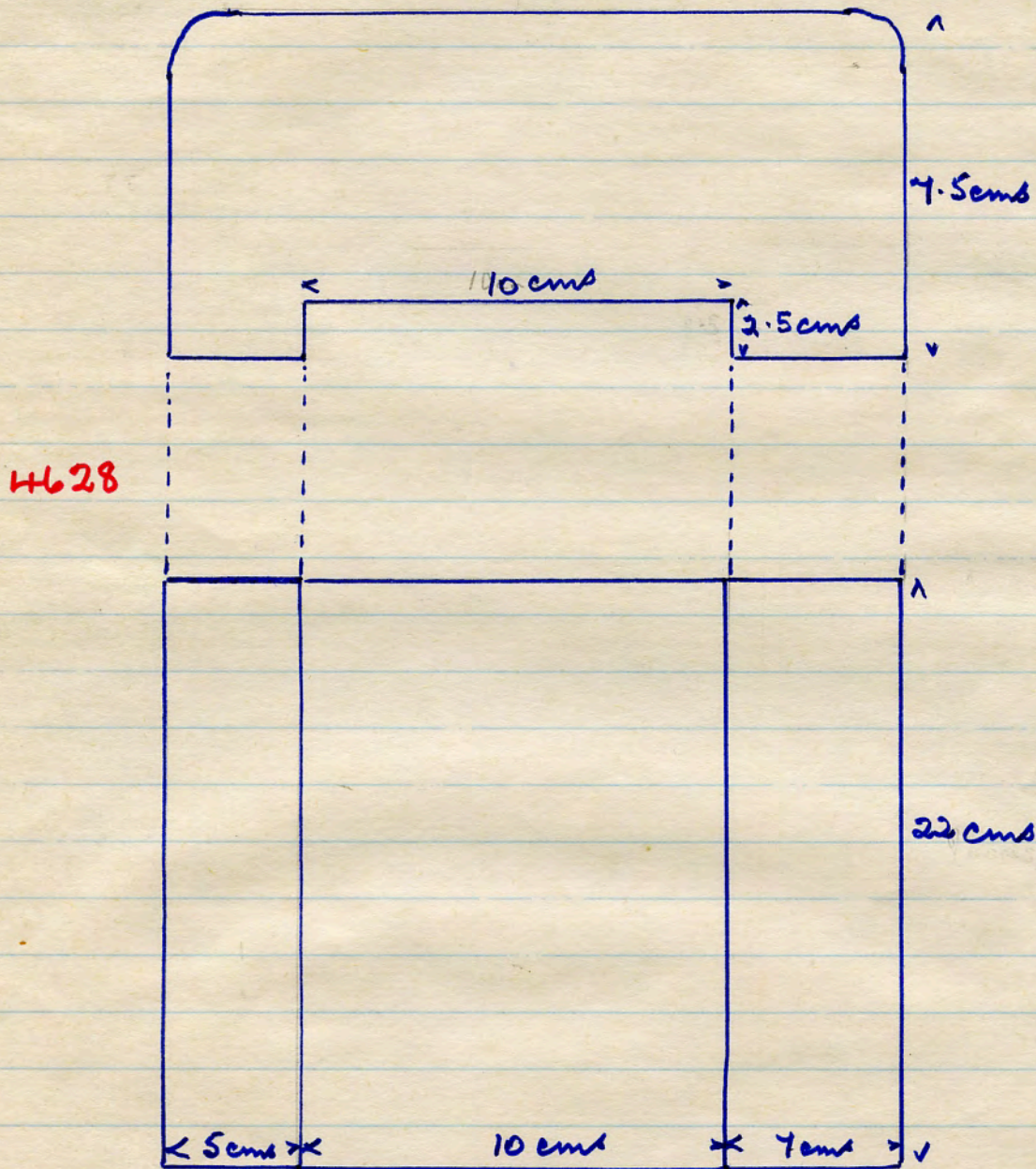

Acception Mari dem. site 5. 7. '90

No name $\frac{1}{2}$ U red T.C. 5 lbs. no panels.

4629

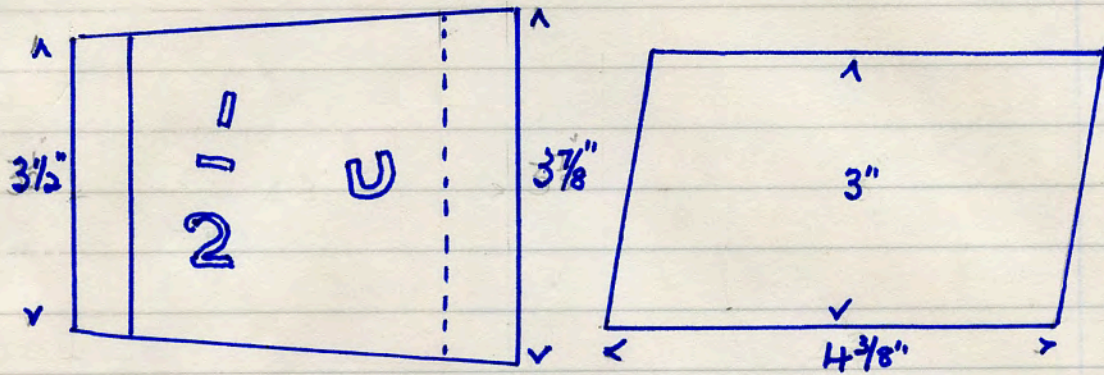

Acpton No. dem. site 5. 7. '90

No name 43N 540 red T.C. 25 lbs
moulder's mark JC

Acpton No. dem. site 5. 7. '90

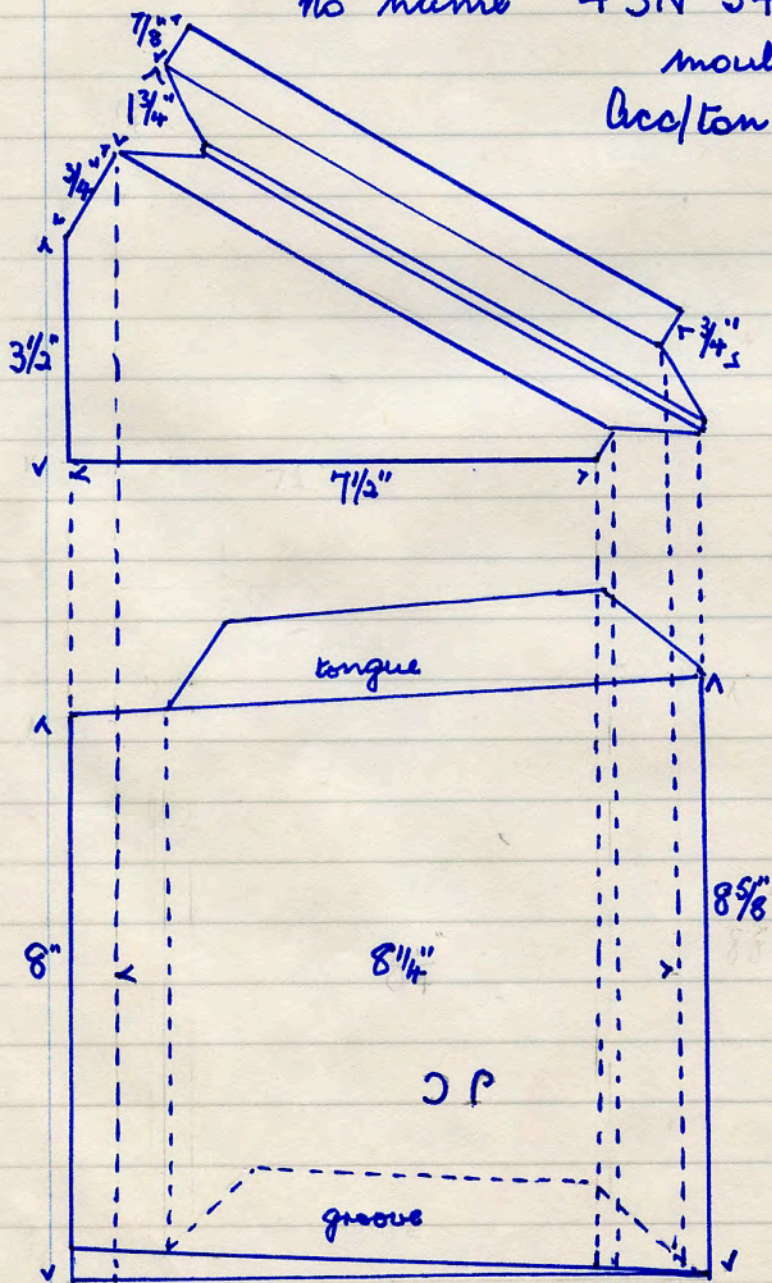

4630

4631

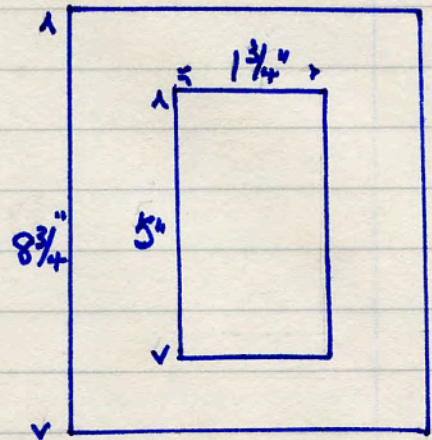
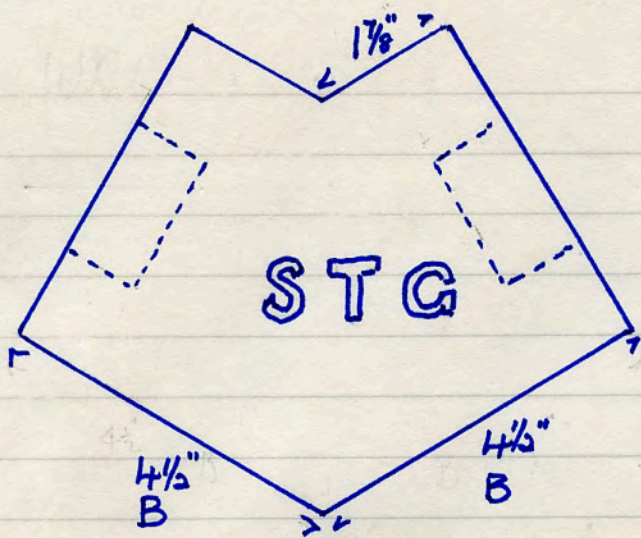

No name STG red T.C brick quoin 18 lbs.

B = face side

Acc/ton Mori dem. site 5. 7. '90

4632

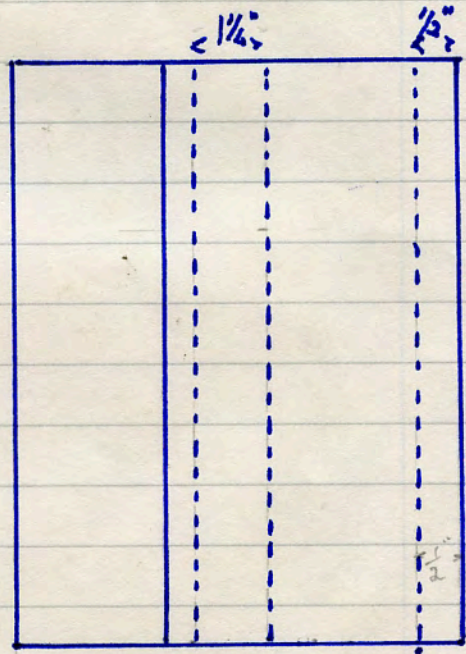
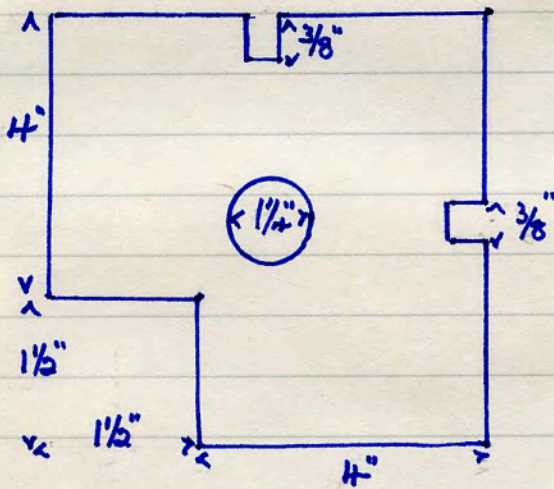

No name 205 T2 red T.C. 20 lbs

Acc/ton Mori dem. site 5. 7. 90

No name 270 TA red T.C. 15 lbs.
 Accpton Mori dem. site 5. 7. 90

4633

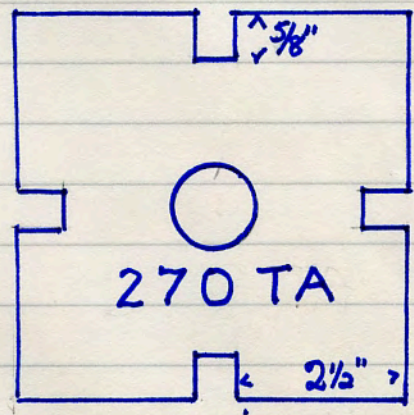
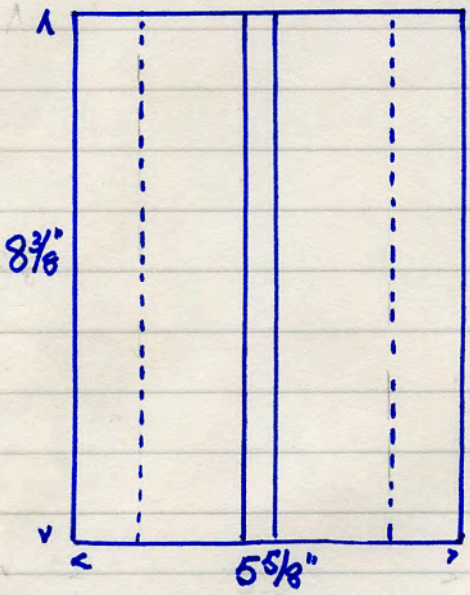

4634

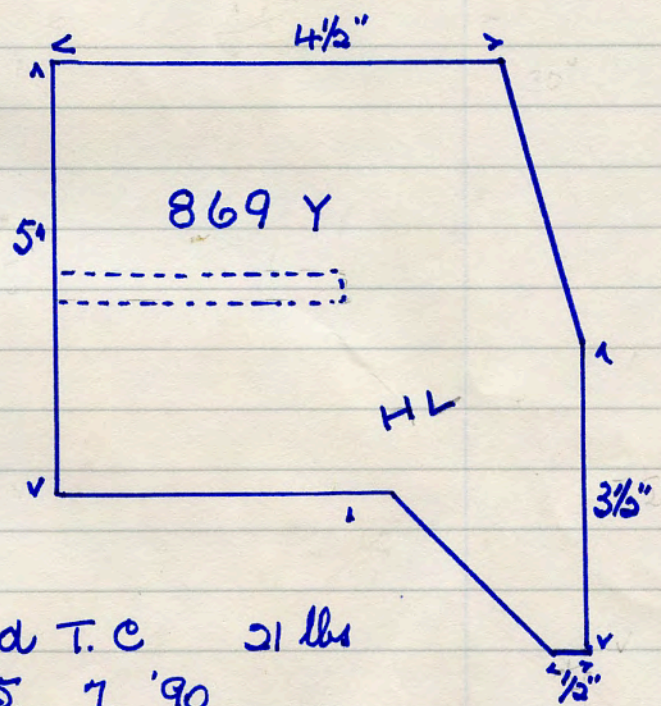
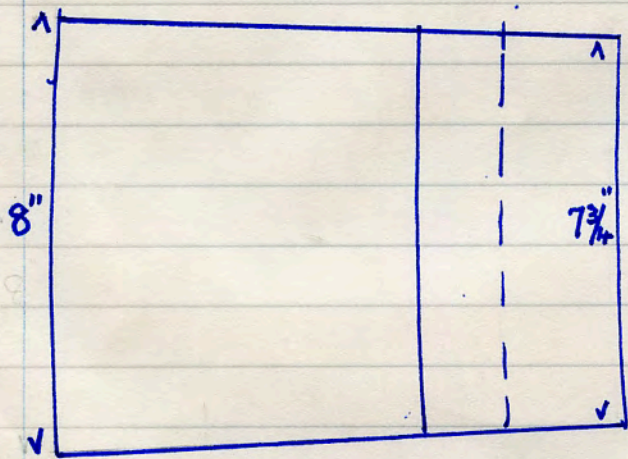

No name 869 Y red T.C. 21 lbs
 Accpton Mori dem. site 5. 7. '90

No name 86 M 11 red T.C. 14 lbs.
 Accpton Mori dem. site 9. 7. '90

4635

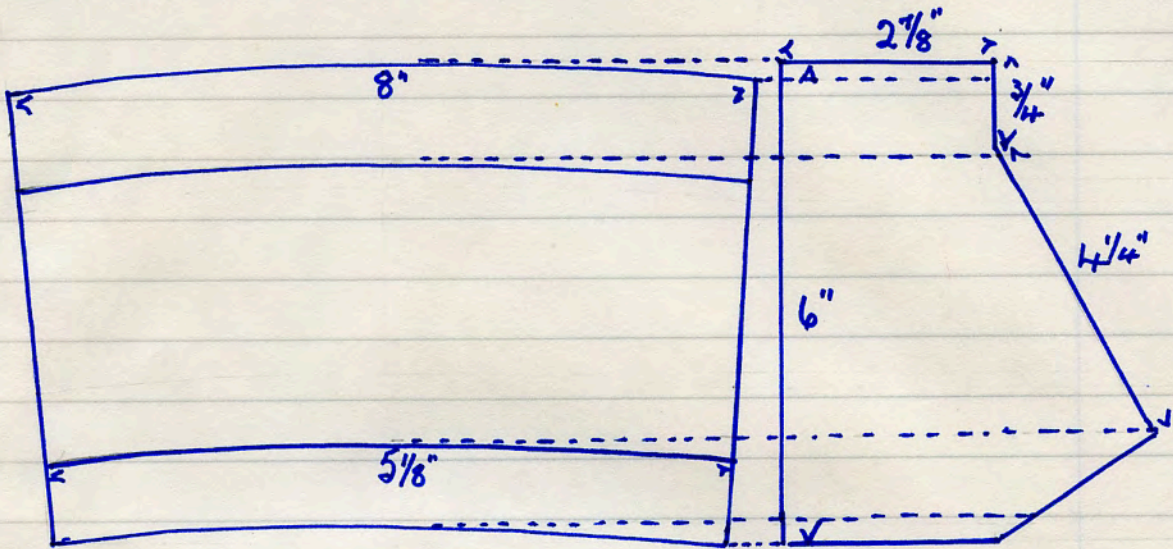

No name 86 M 7 red T.C. 14 lbs

4636

4636

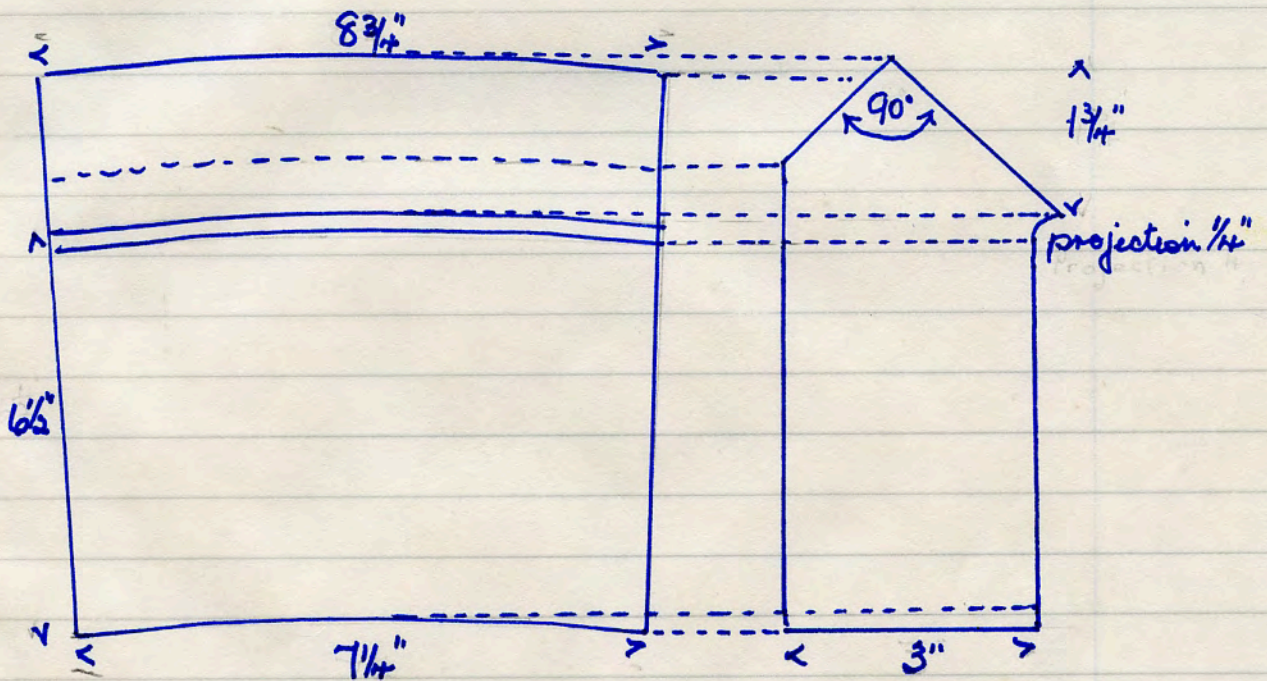

Accpton Mori dem. site 9. 7. '90

No name 174 T Q red T.C. 10 lbs.
 Acpton Mori dem. site 9. 7. '90

4637

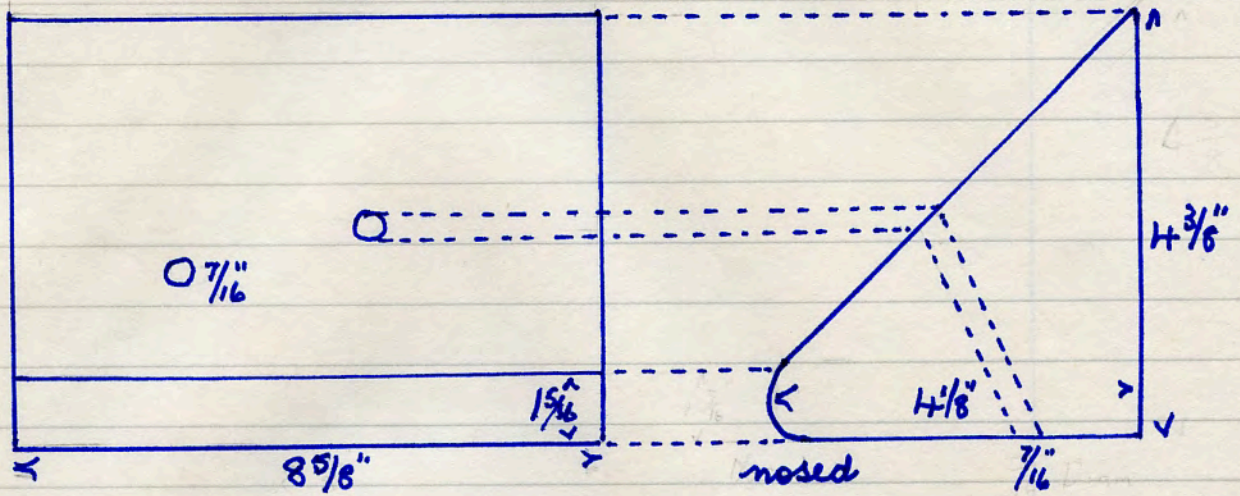

4638

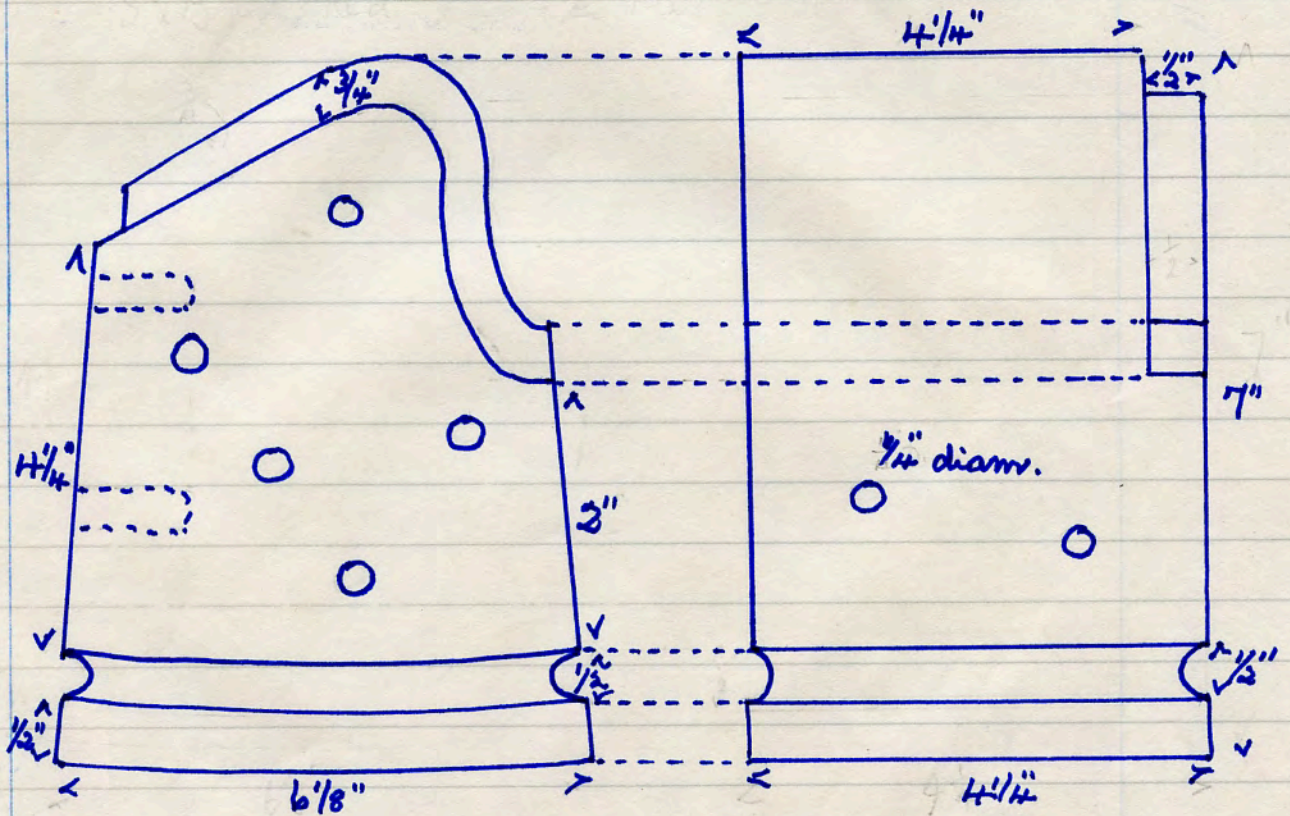

No name 52 B 20 red T.C. 12 lbs
 moulder's mark DW stamped
 Acpton Mori dem. site 9. 7. '90

4639

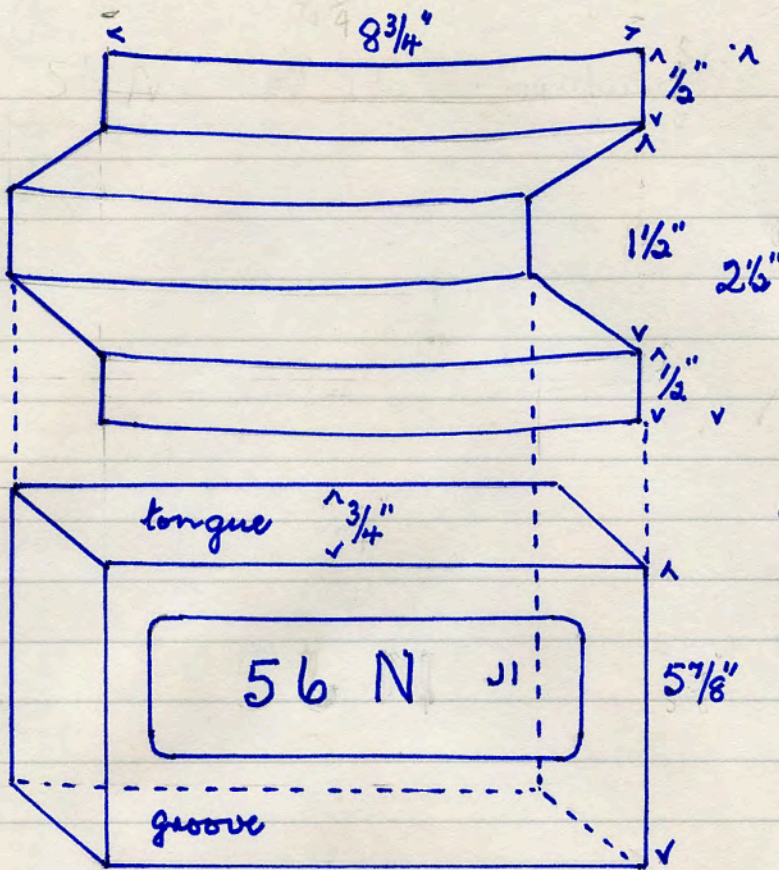

No name
 56 N
 red T. C
 12 lbs
 moulder's mark J1

Acfton Mori
 dem. site
 9. 7. '90

No name J15 red T. C. 10 lbs

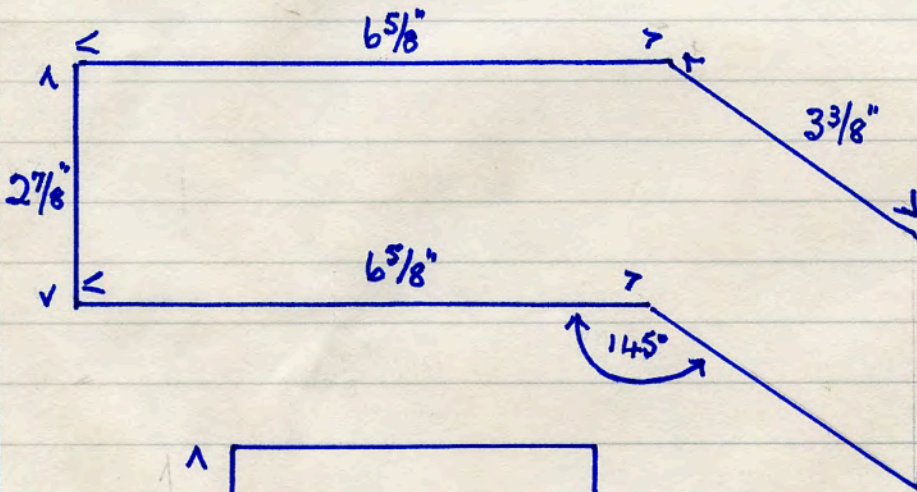

4640

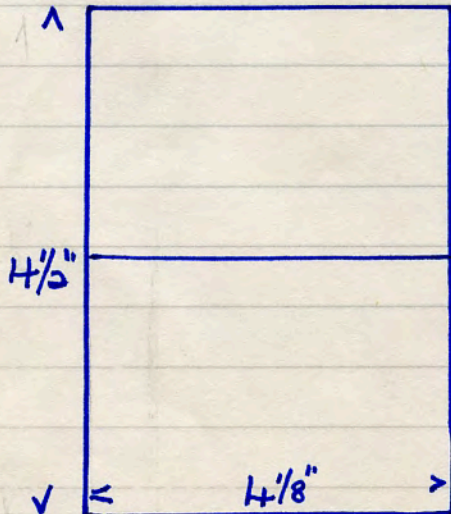

Acfton Mori dem. site
 10. 7. '90

No name 79 71 Bowland Brown wall cap
22 cms long 28 lbs.

4641

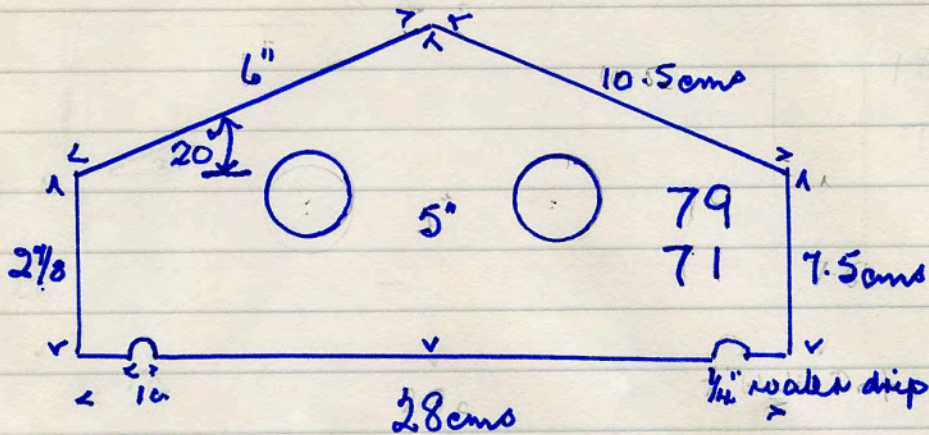

No name 130 D red T.C 8 lbs

4642

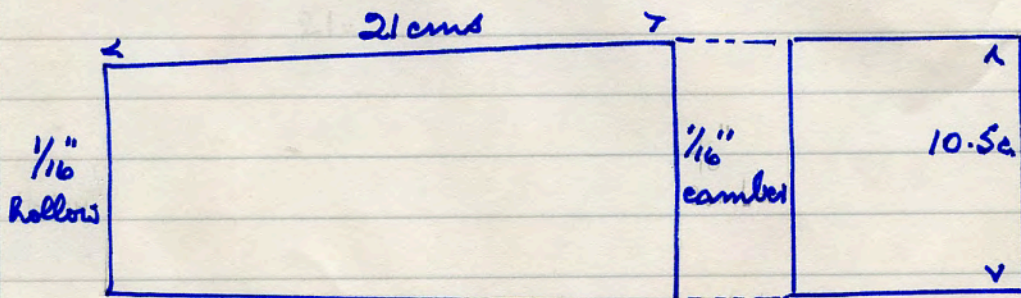

No name 35 M 19 red T.C. 8 lbs

4643

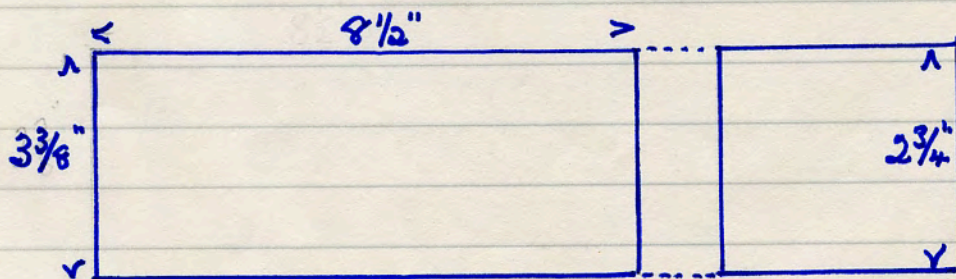

All above - Acpton Moss dem. site 10. 7. '90

4644

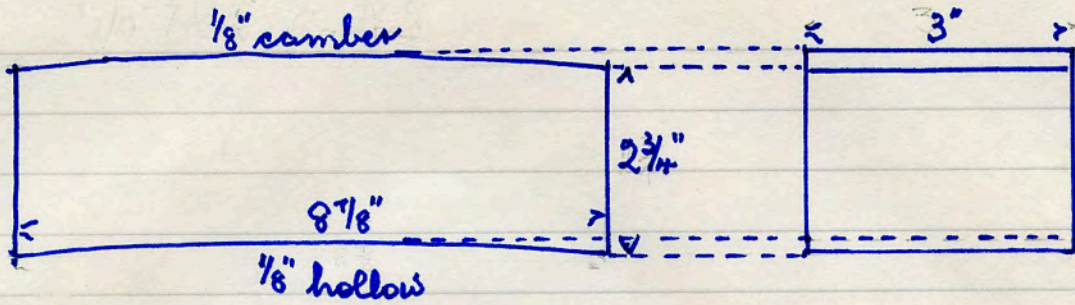

No name P2 red T.C. 7lbs
 Acpton Mori dem. site 10. 7. '90

4645

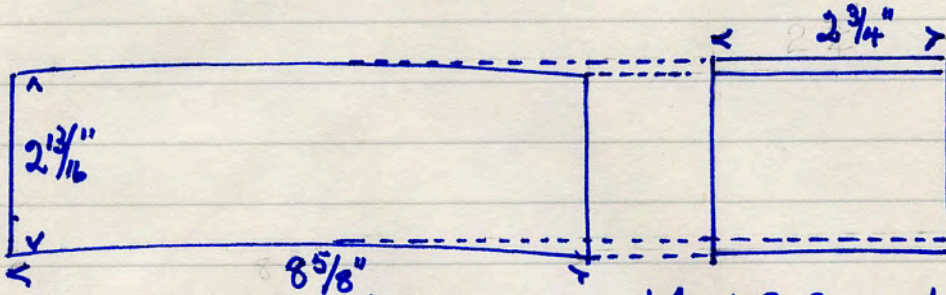

No name. 14 C9C red T.C. 7lbs.
 Acpton Mori dem. site 10. 7. '90

No name 29 P 312 red T.C. 7lbs
 Acpton Mori dem. site 10. 7. '90

4646

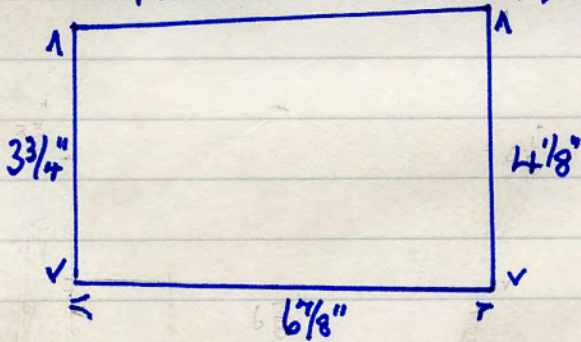

No name 35 M1 red T.C. 5 1/2 lbs.
 Acpton Mori dem. site 10. 7. 90

4647

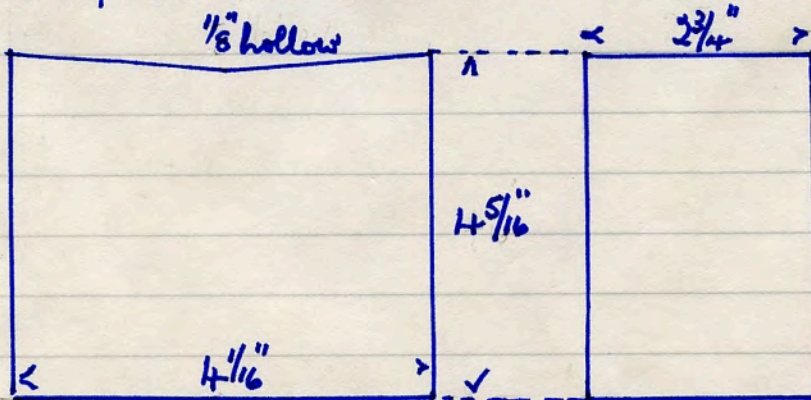

No name 34 P 86 red T.C. 7lbs.

4648

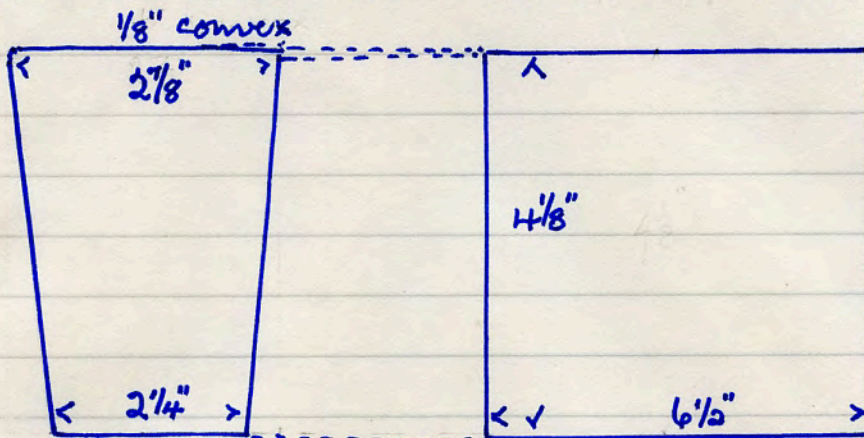

Acpton Mori dem. site. 11. 7. '90

4649

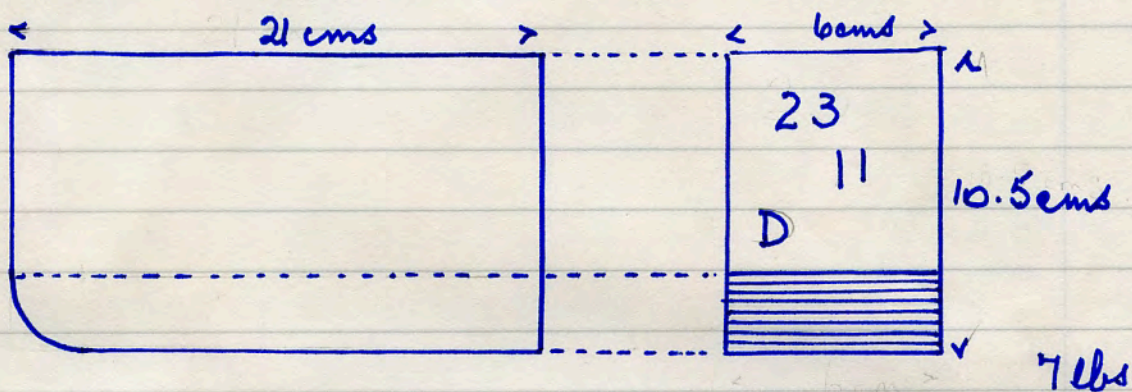

No name 23 11 D Bowland Brown wire run

4650

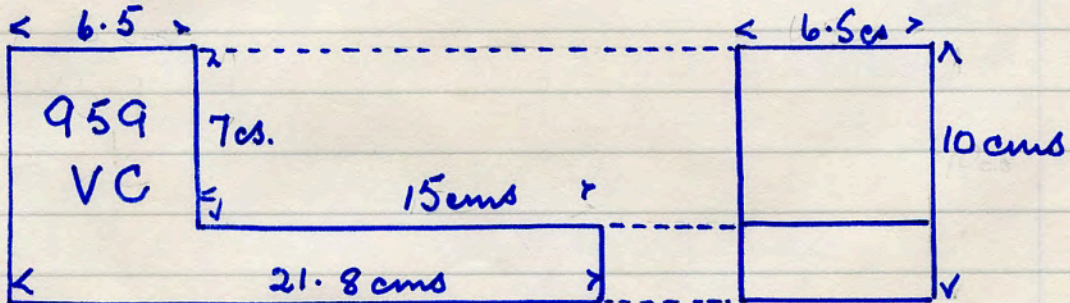

No name .959 VC. red T.C. wire run 5lbs

4651

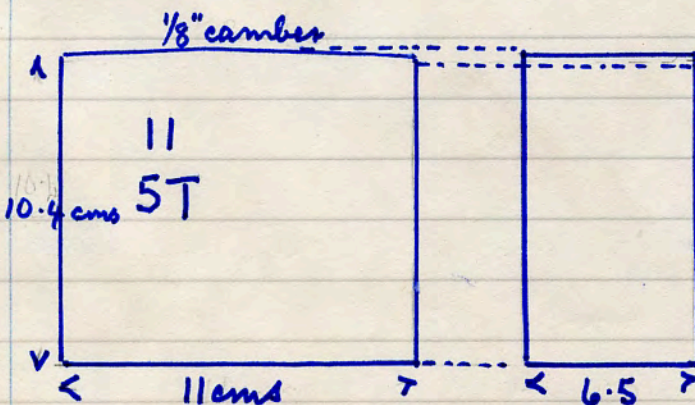

No name 11 5T red T.C. wire run 5lbs

All above - Acpton Mori dem. site 12. 7. '90

4652

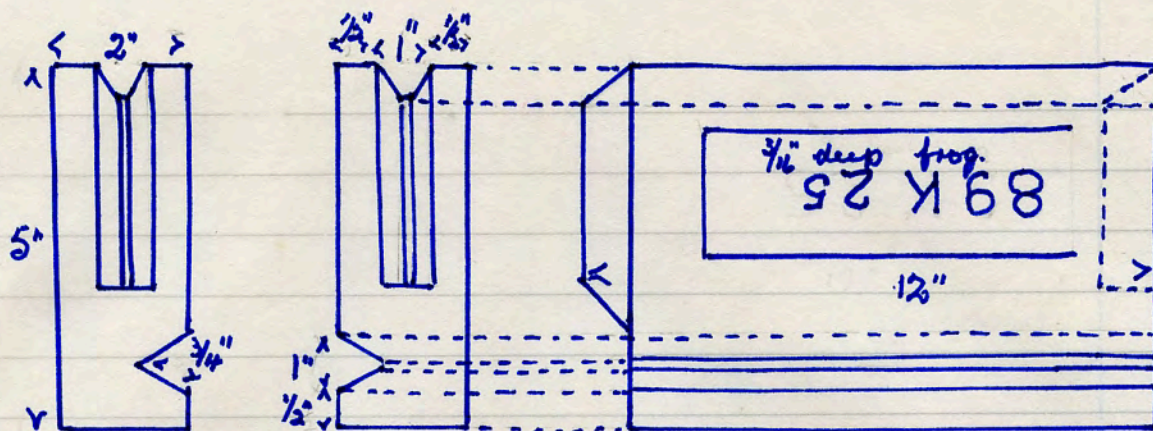

No name 89K 25 red T.C. 9 1/2 lbs 6 perfs to help burning

4653

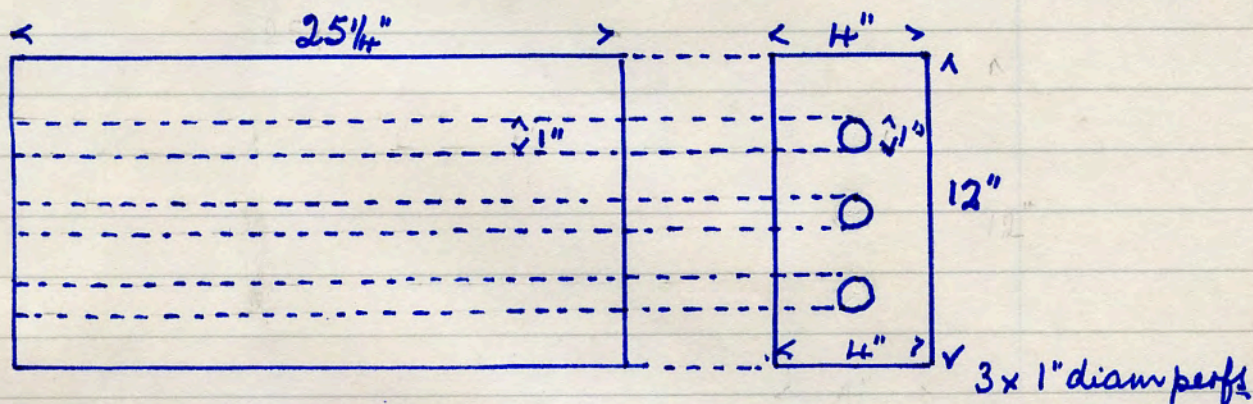

No name 91 F 96 red T.C. 100 lbs. 25 1/4" x 12" x 4"

4654

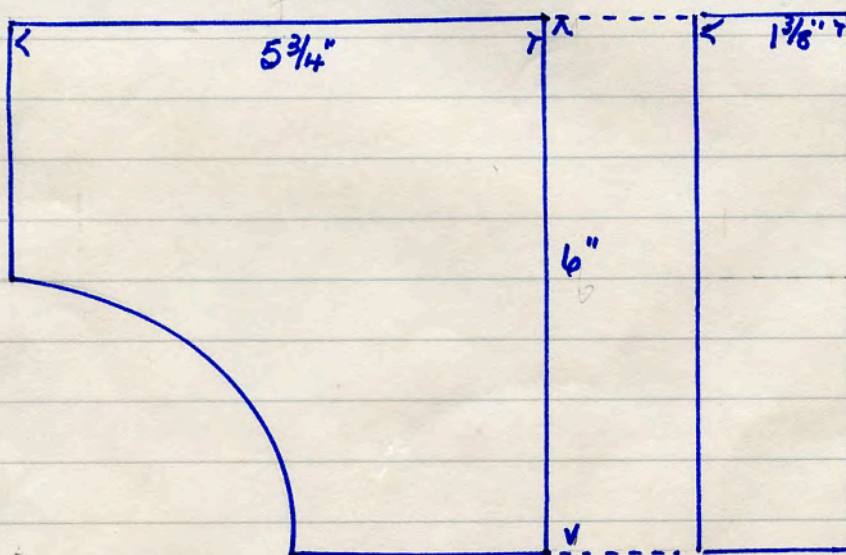

No name 734 V 2 red T.C. 4 lbs

All above - Acpton Mass dem. site 12. 7. '90

4655

4655

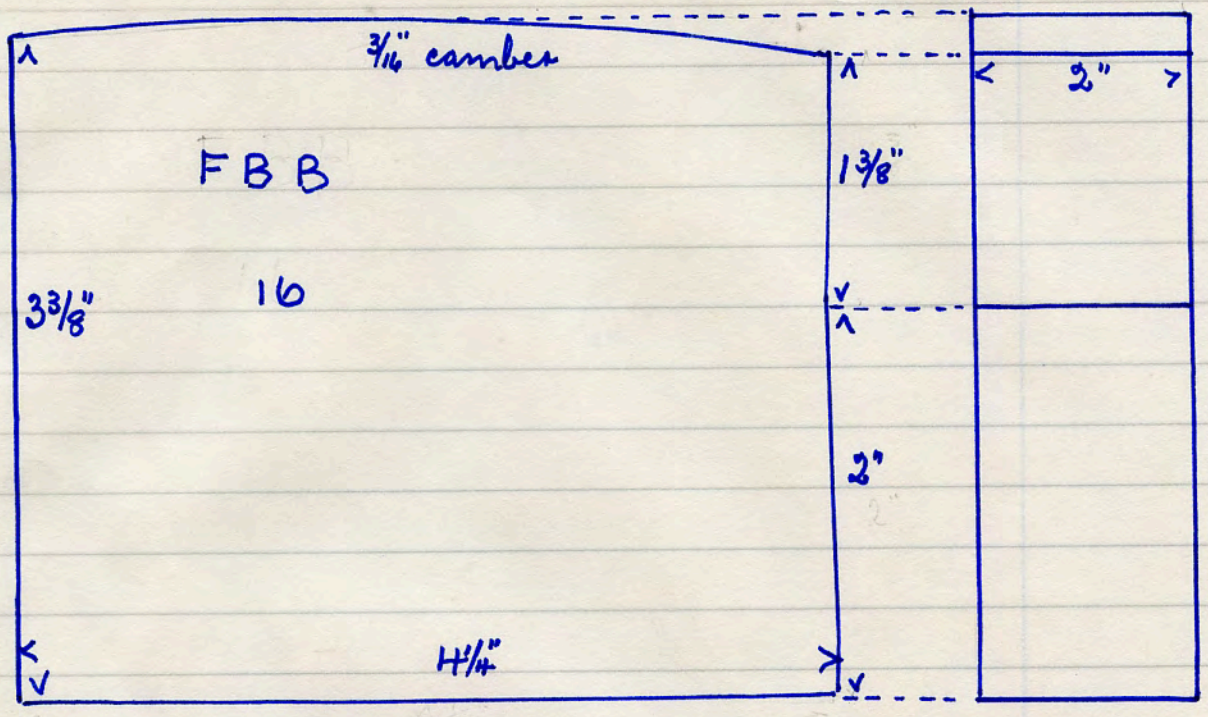

No name FBB 16 red T.C. 2 lbs.
 Section Mori dem. Site 13. 7. '90

No name 734 V4 red T.C. 9 lbs

4656

4656

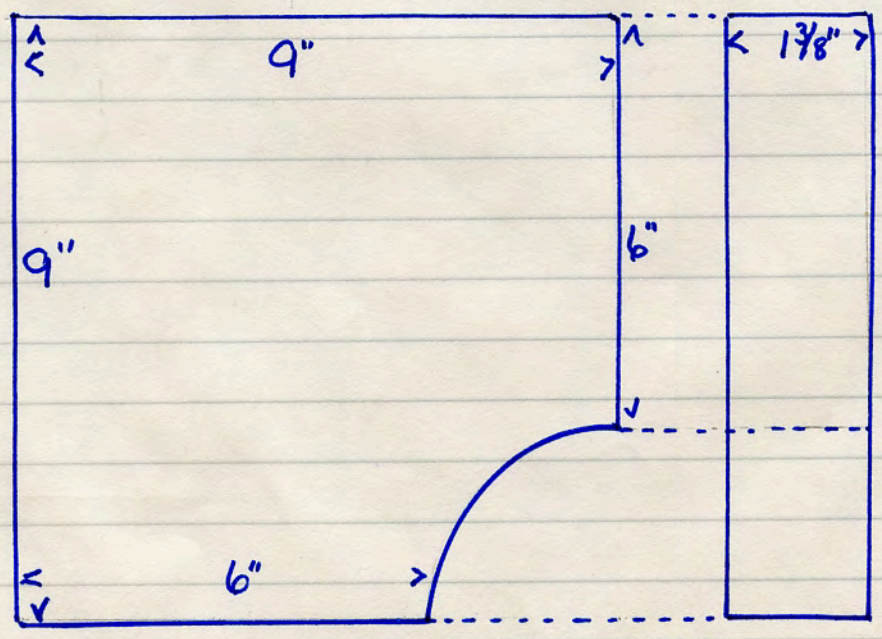

Section Mori dem. Site 13. 7. '90

No name 31P 60 red T.C. 5 lbs.

4657

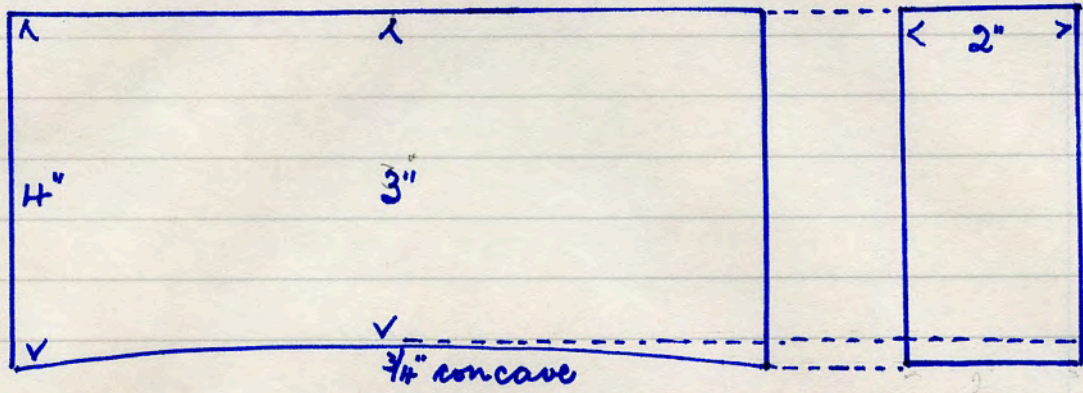

Acfton Mori dem. site 13. 7. '90

No name 31P 297

red T.C.

moulder's mark

|| (2 scribes)

4658

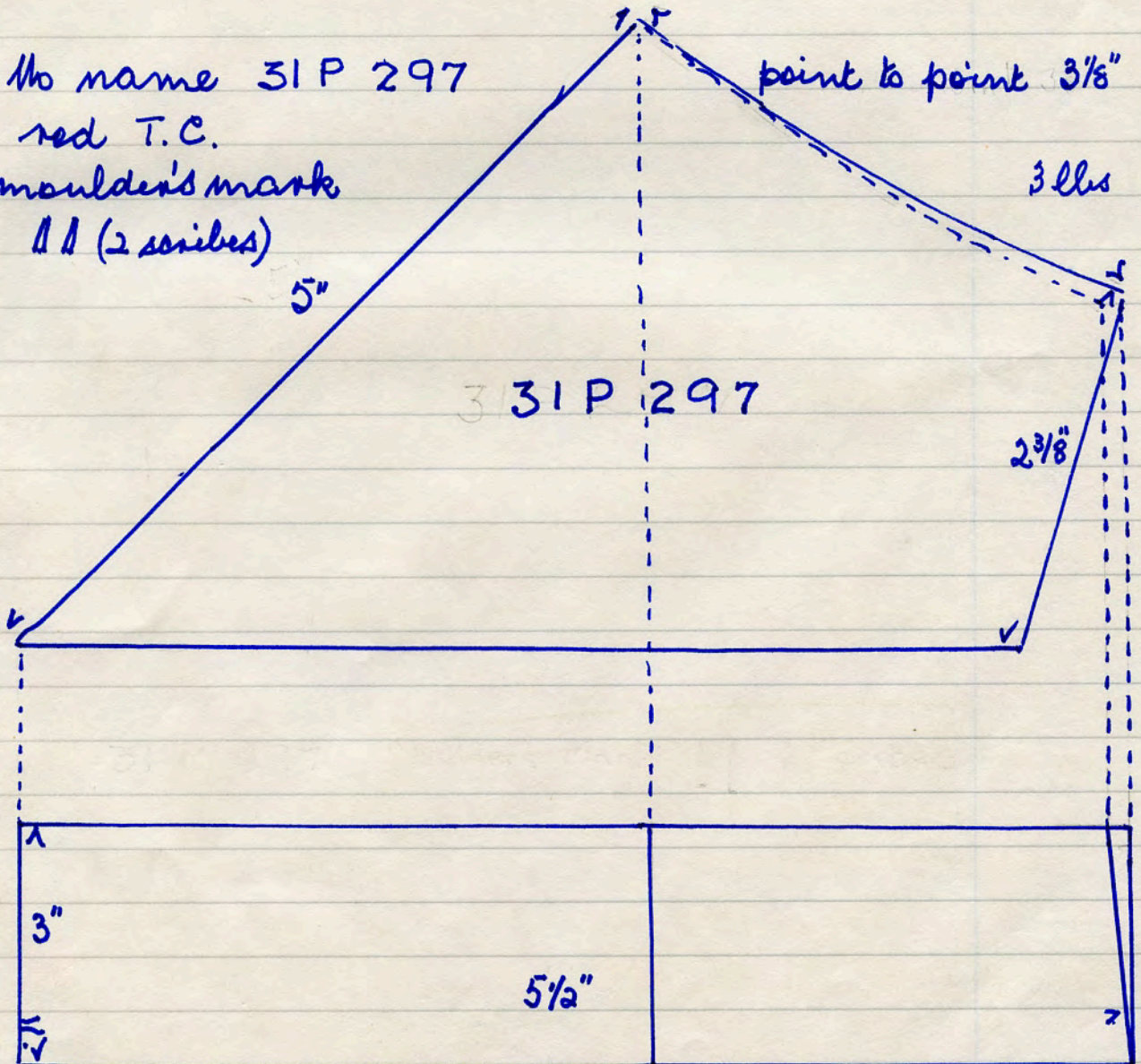

Acfton Mori dem. site 13. 7. '90

4659

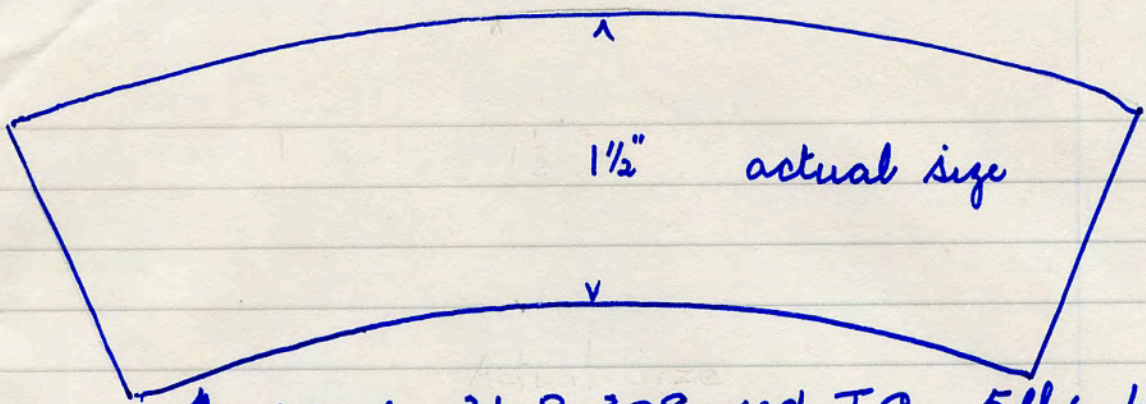

No name 31 P 308 red T.C. 5 lbs 6" long

4660

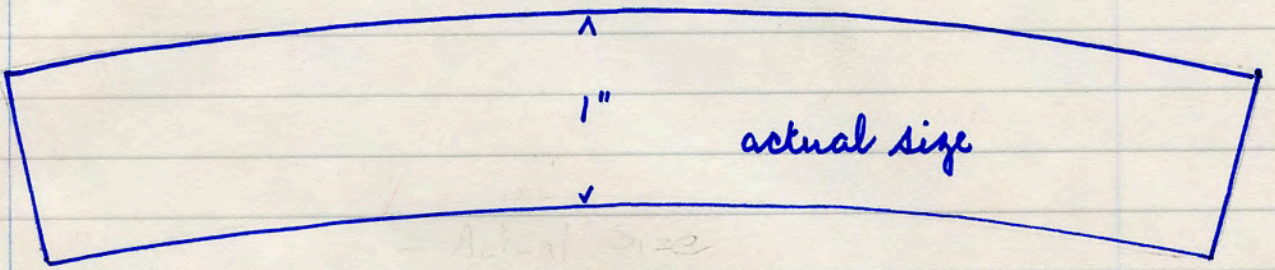

No name. 32 MI red T.C. 3 1/2 lbs. 7" long.

4661

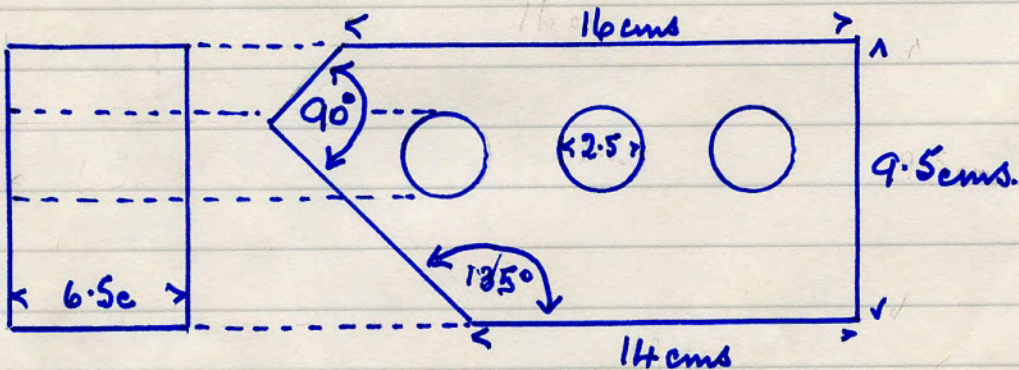

No name 2412 EL Bowland Brown 5 lbs
rough rustic finish 1 face edge and end
this brick makes a pair with No 4368

No name 2972 D Bowland Brown wall cap return
 16 lbs (not dressed off)

Acpton Mori dem. site 13. 7. '90 $1\frac{5}{8}$ "

4662

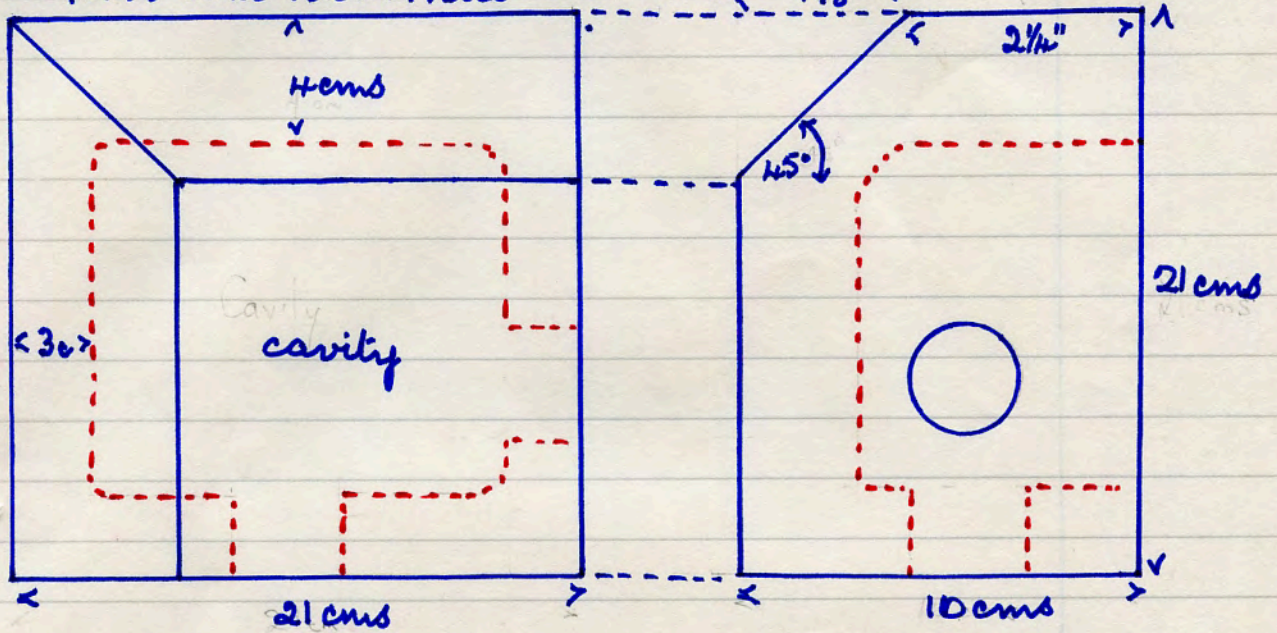

4663

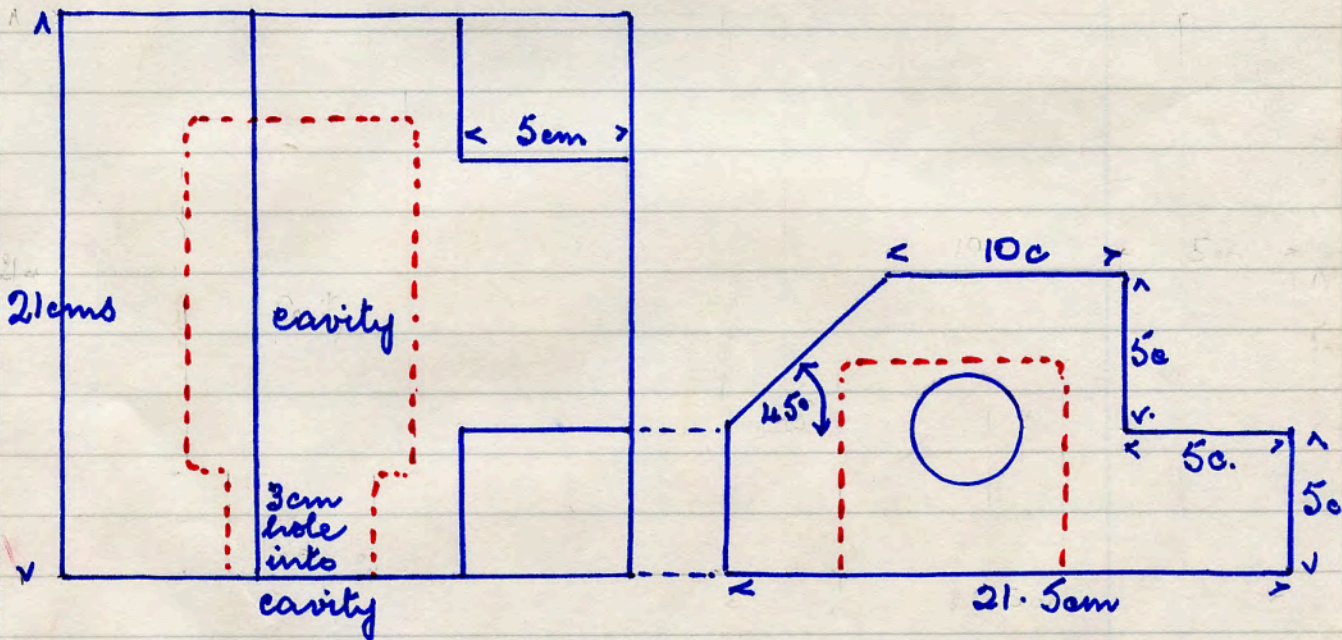

No name 123 T3 Bowland Brown wall cap with
 16 lbs 2 cut outs

Acpton Mori dem site 13. 7. '90

4664

4664

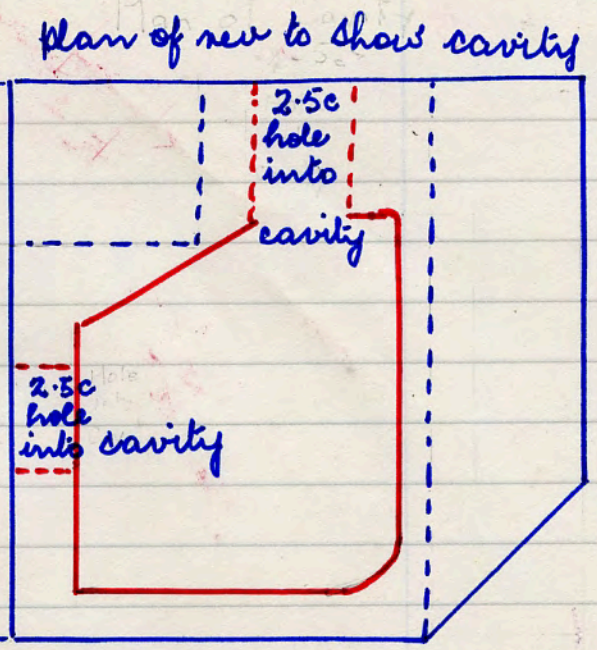
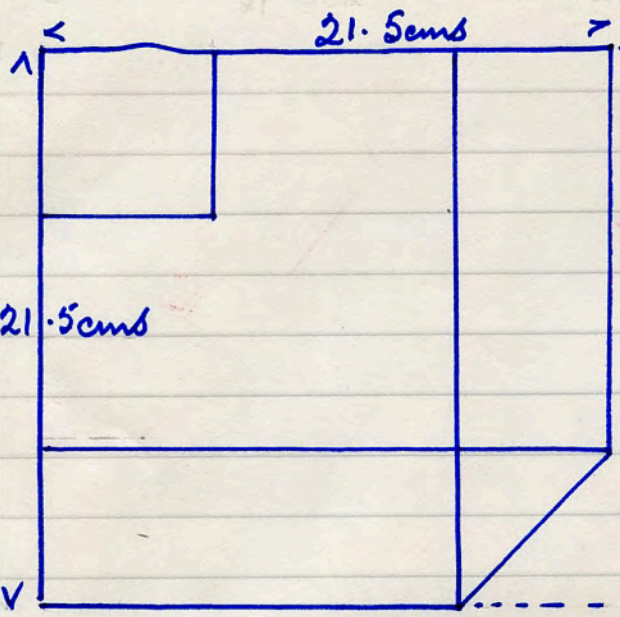

No name 123 T2 Bewland Brown chamfered return
 15 lbs. Accpton Mori dem. site 13. 7. 90

4665

4665

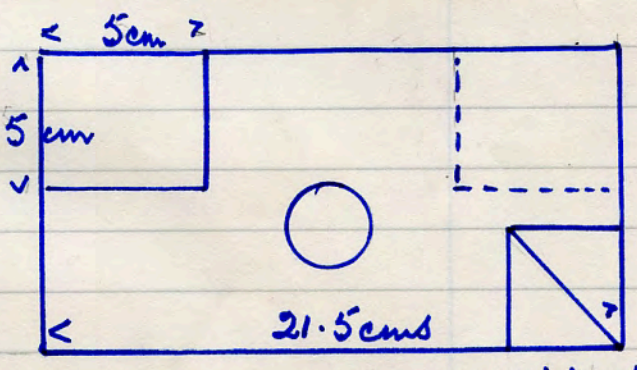
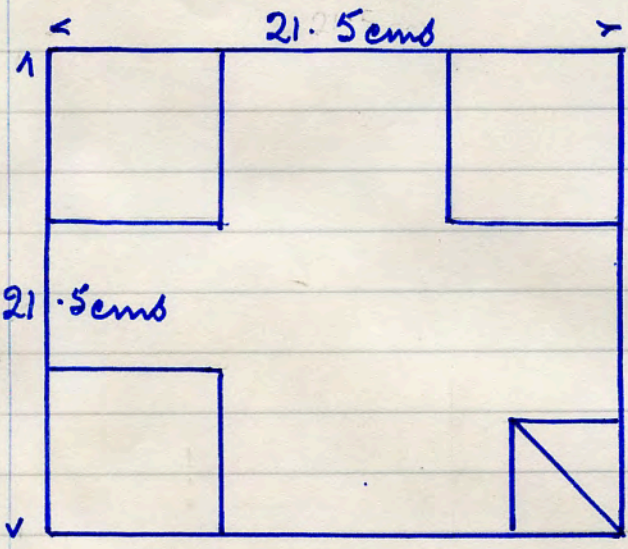

No name 123 T4 Bewland Brown 16 lbs
 with mitred return
 Accpton Mori dem. site 13. 7. '90

No name 69 Q 15 red T.C. 5 lbs

4666

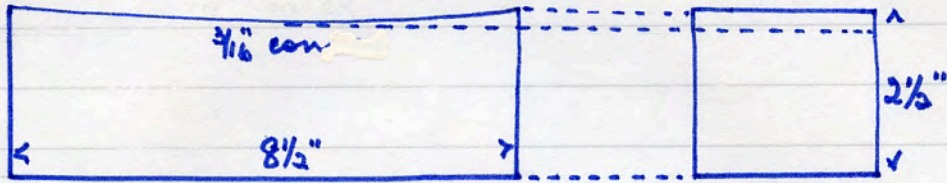

No name 27150 red wire run gauged bricks 7 lbs

4667

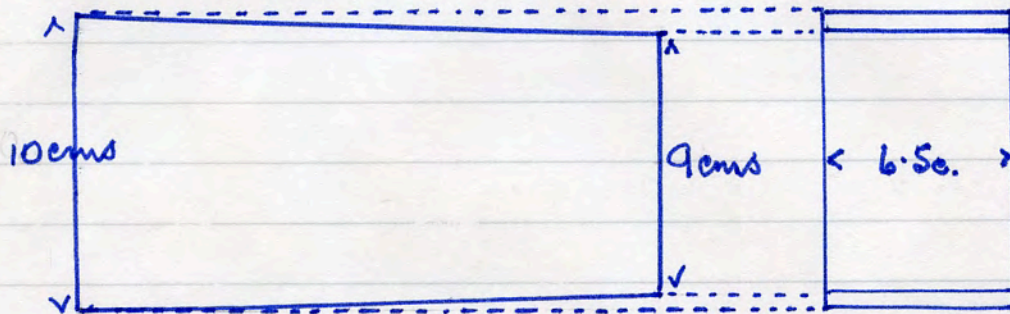

4668

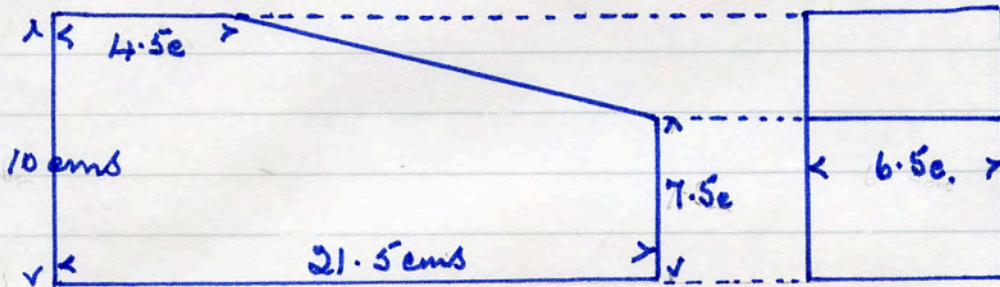

No name 21 R 11 red wire run bricks 7 lbs

4669

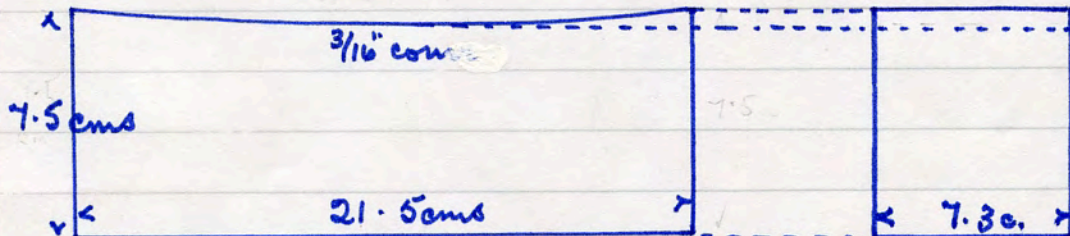

No name 69 Q 29 red T.C. 7 lbs.

All above - Ocifton Mari dem. site 16. 7. '90

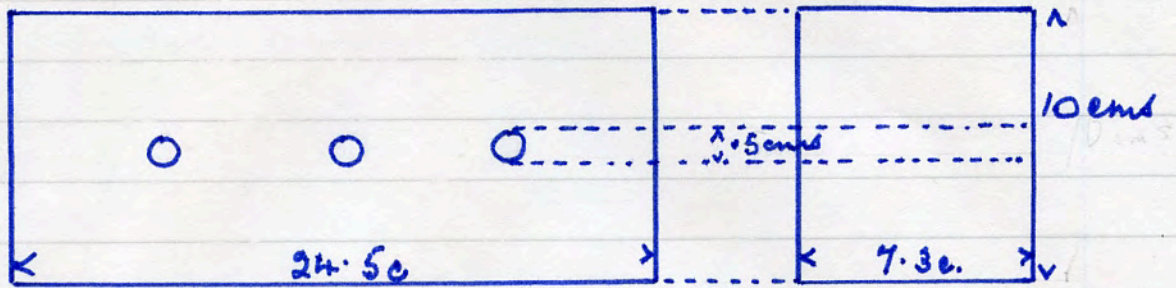

4670

No name. 211TA red T.C. 10 lbs
 Acpton Mori dem. site 16. 7. '90

No name KB. red T.C. 7 lbs moulder's mark TH.

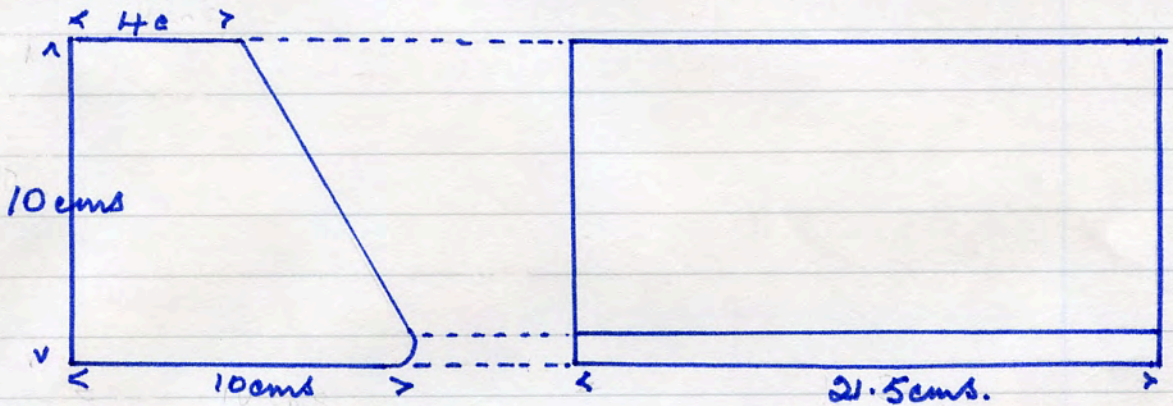

4671

Acpton Mori dem. site 16. 7. '90

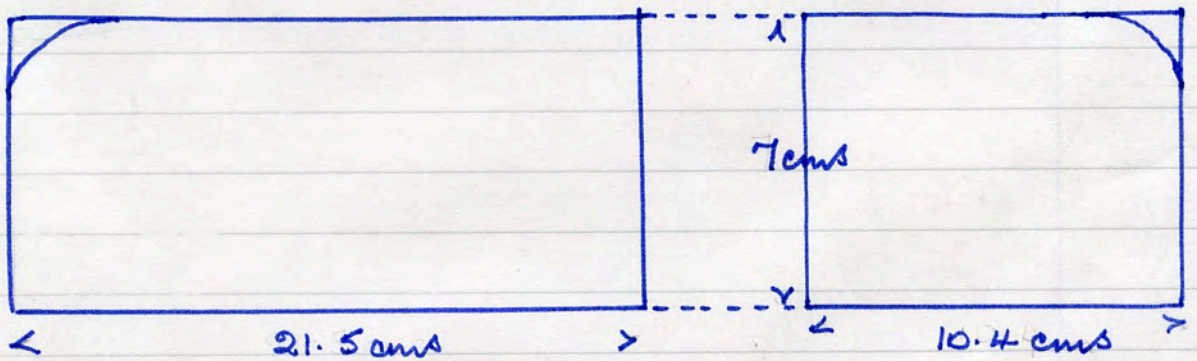

4672.

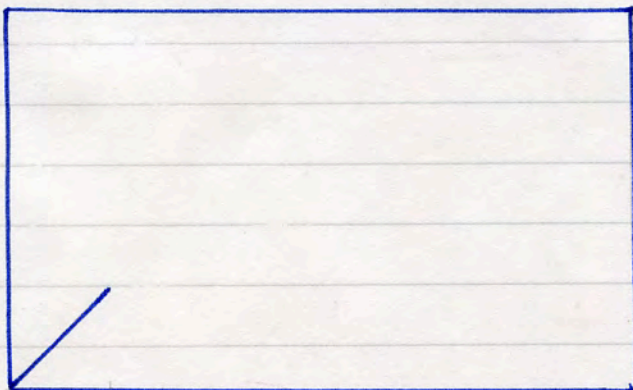

No name PML
 red T.C. 9 lbs

Acpton Mori dem. site
 17. 7. '90

No name PSA red T.C. 14 lbs

4673

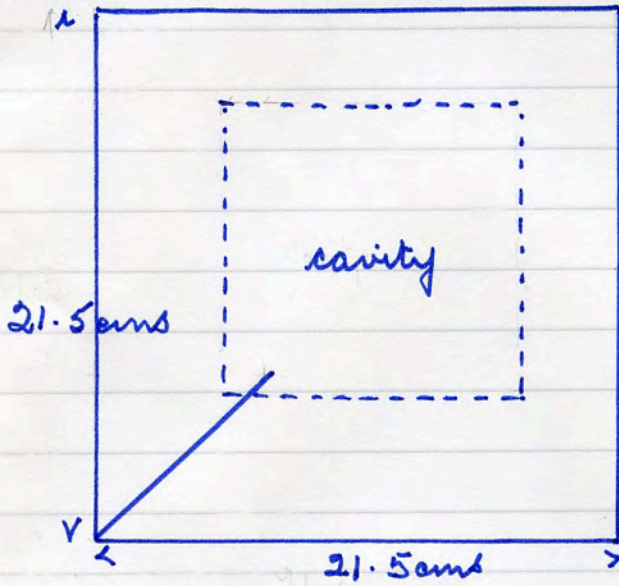

Acpton Mori dem. site
14. 7. '90

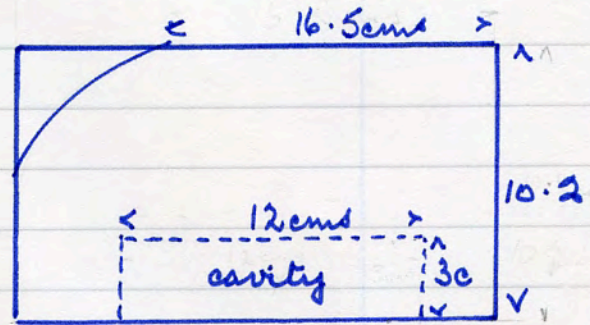

No name SBA red T.C. 15 lbs

4674

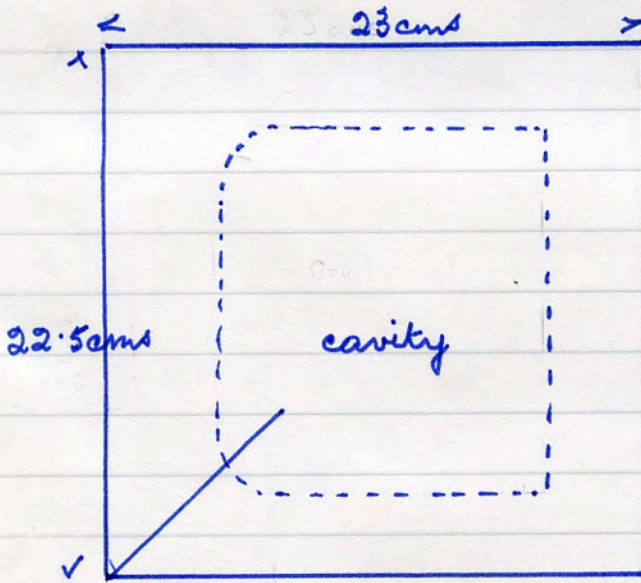

Acpton Mori dem. site 14. 7. '90

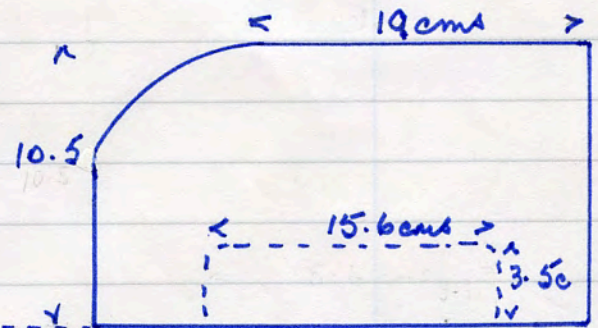

No name PMJ red T.C. 6 lbs

4675

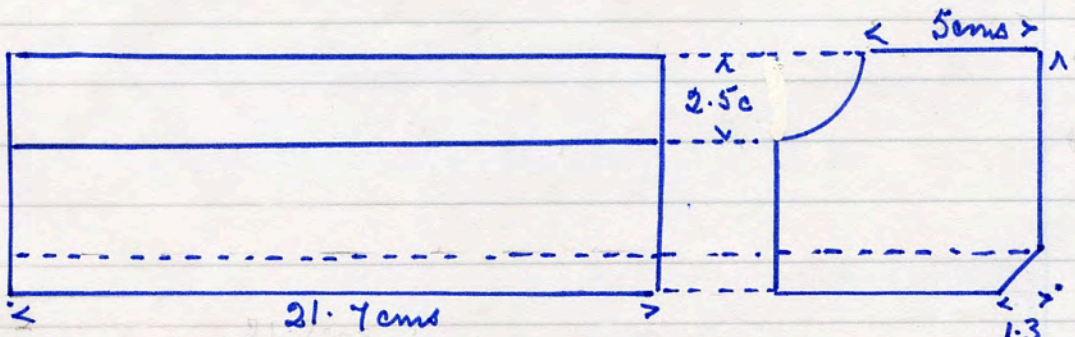

Acpton Mori dem. site 14. 7. '90

4676

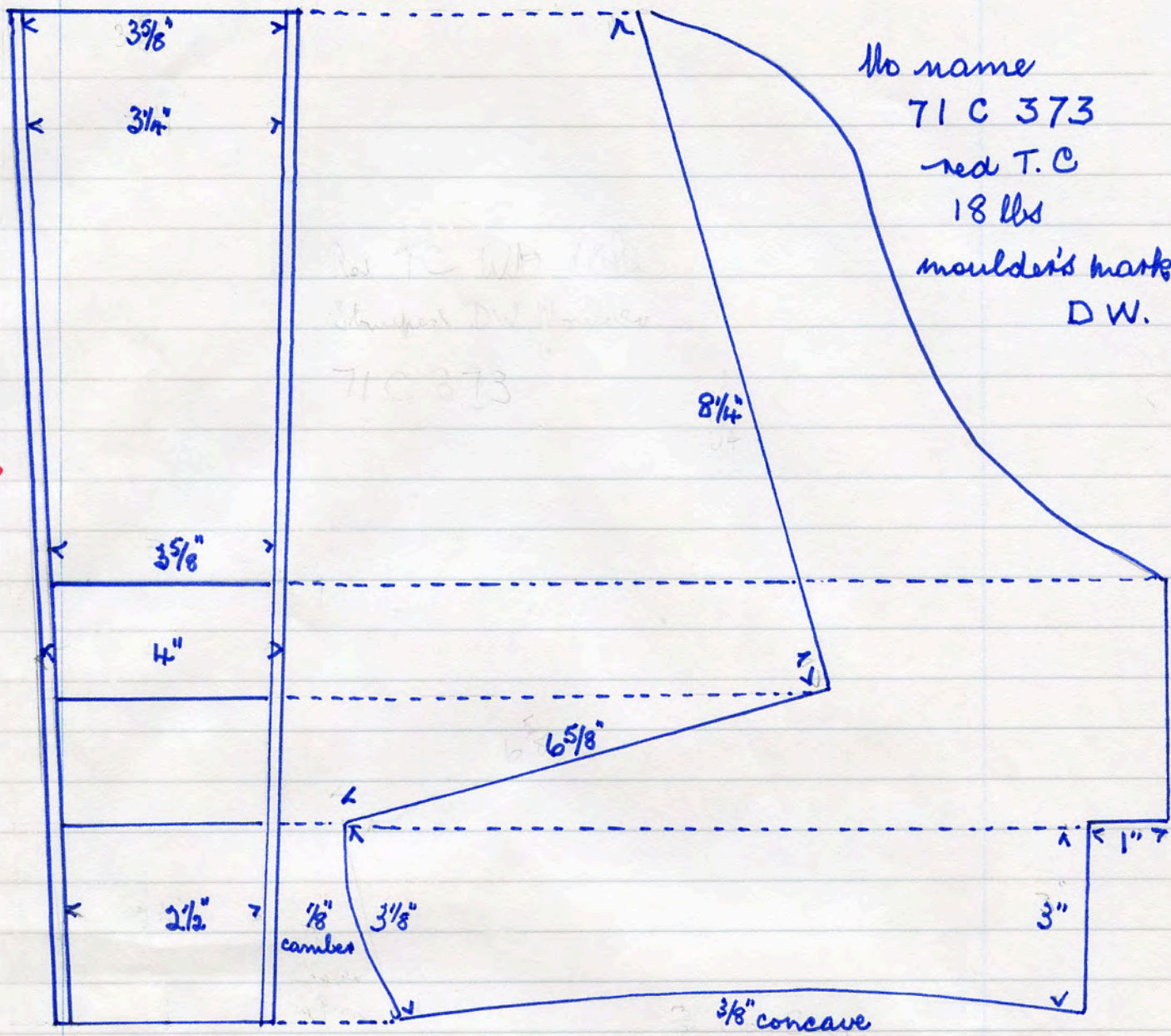

Acpton Mori dem. site 17. 7. '90

4677

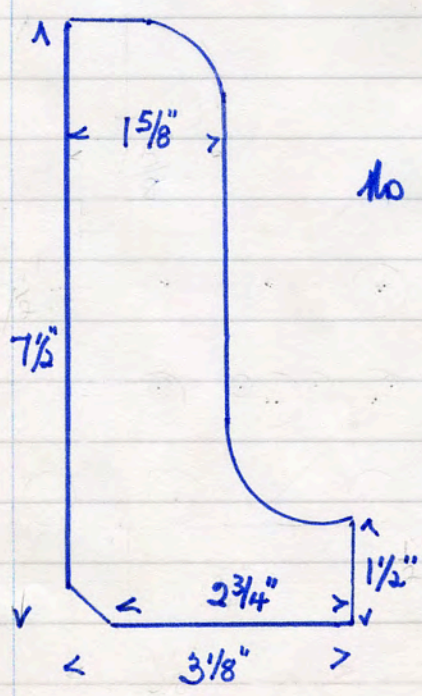

No name 333 V red T.C. 10 1/2 lbs length 8 1/2"

Acpton Mori dem. site 17. 7. '90

No name 24 13C Bowland Brown squint 5 lbs
 Accpton Mori dem. site 14. 7. '90

4678

4678

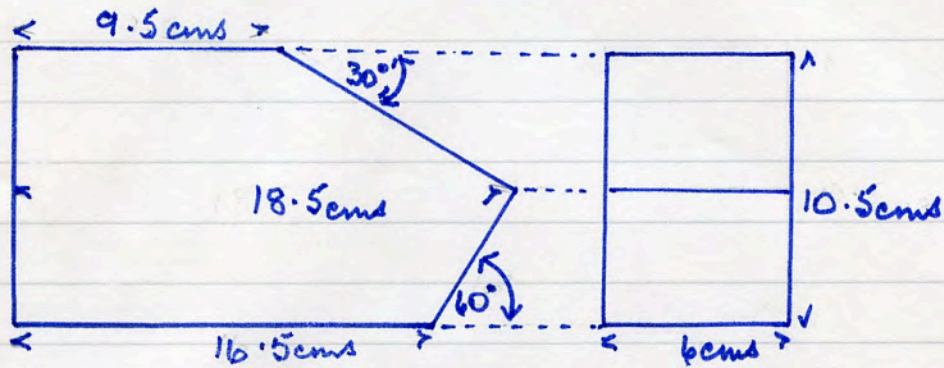

No name, no numbers. Sand faced brick by Acc. B+J 60 lbs
 sand 1 face + 2 ends. 14 x 1.5 cm diam 2 x .5 cm diam perfs.

4679

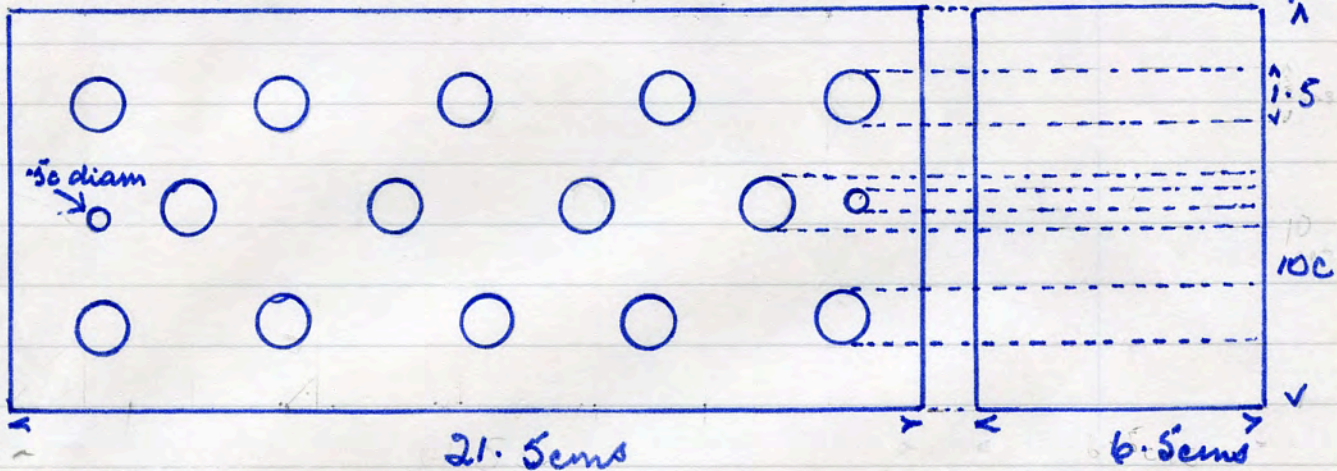

5 lbs Accpton Mori dem. site 14. 7. '90

4680

No name JDS bull nose brick. 8 lbs
 rustic finish 1 face edge and bull nose.

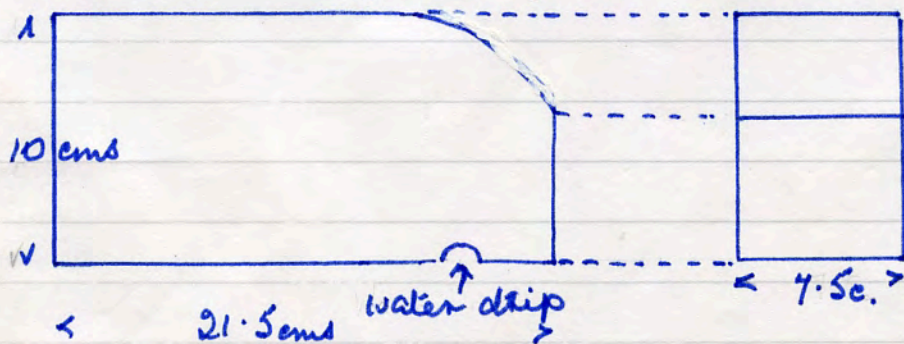

Accpton Mori dem. site 14. 7. '90.

No name 12 H 10X red T.C. 5 lbs.

4681

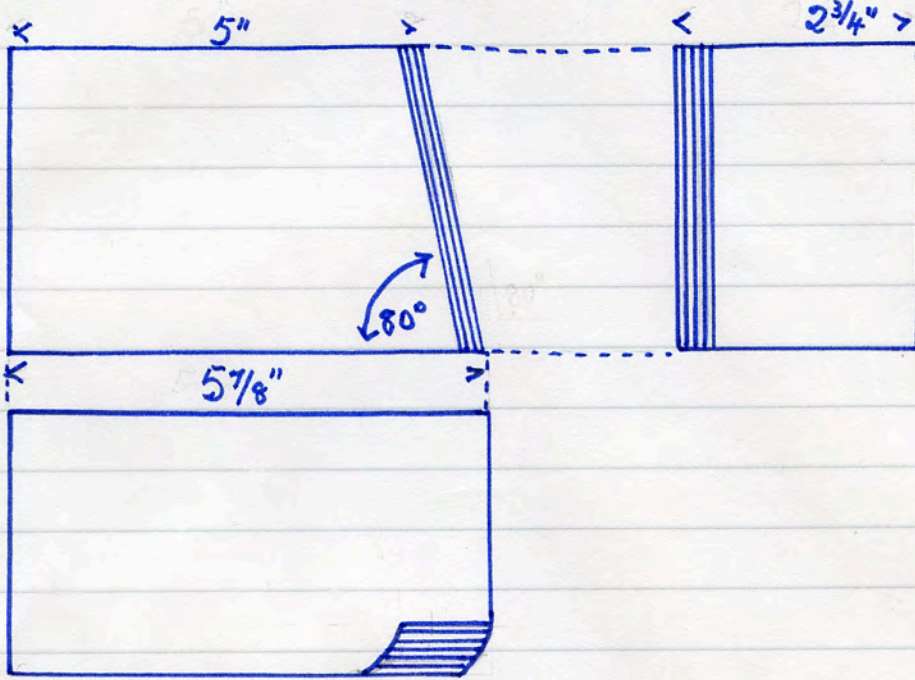

4682 No name PP 17 red T.C trough 8 5/8" long 8 1/2 lbs

Acpton Mossi dem.
site 17. 7. '90

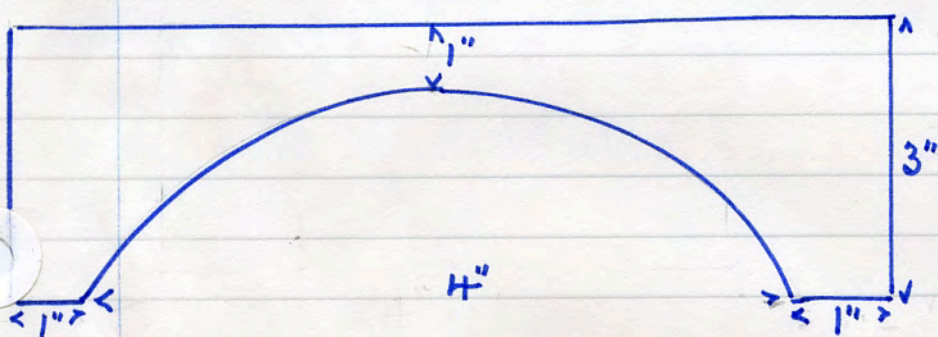

No name 34 H 42 plain red T.C tile 8 3/16" square 8 1/2 lbs

4683

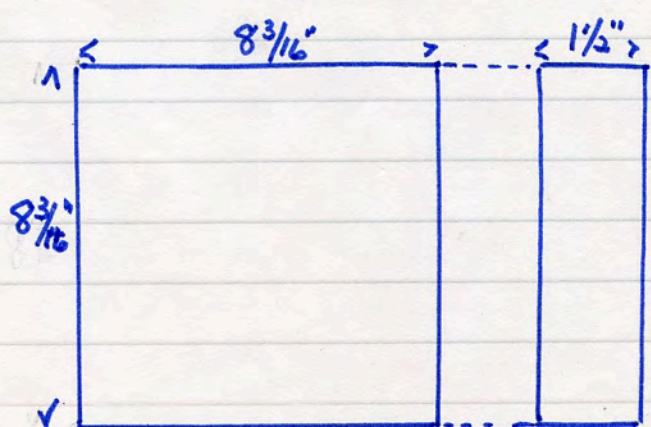

Acpton Mossi dem.
site 17. 7. '90

No name ST 45 red T.C. 8 lbs

4684

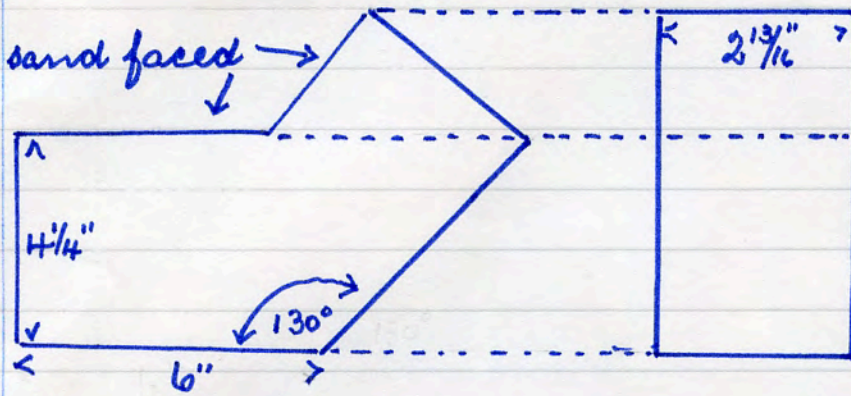

Acpton Mori
dem. site
14. 7. 90

No name no number plain piece of Bowland Brown

4685

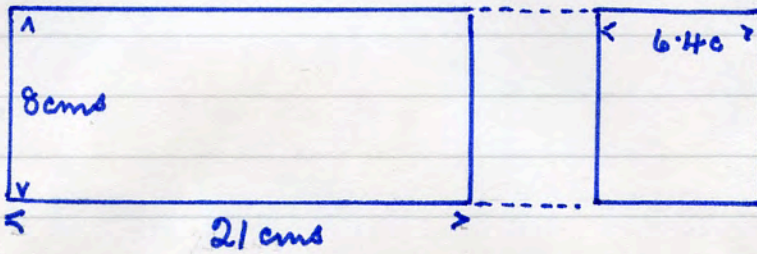

21 cms x 8 cms x 6.4 cms
5 1/2 lbs.

Acpton Mori dem.
site 14. 7. '90

No name 64 U red T.C. 7 lbs exterior edge sand faced.

4686

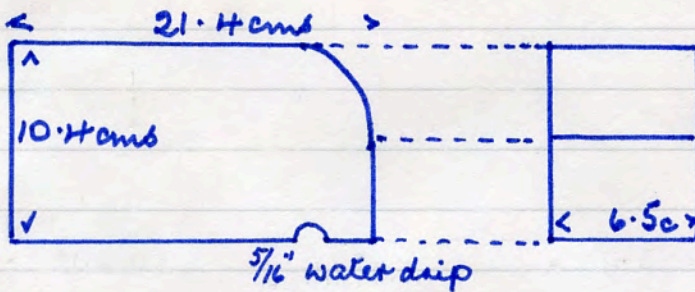

Acpton Mori dem. site
14. 7. '90

4687

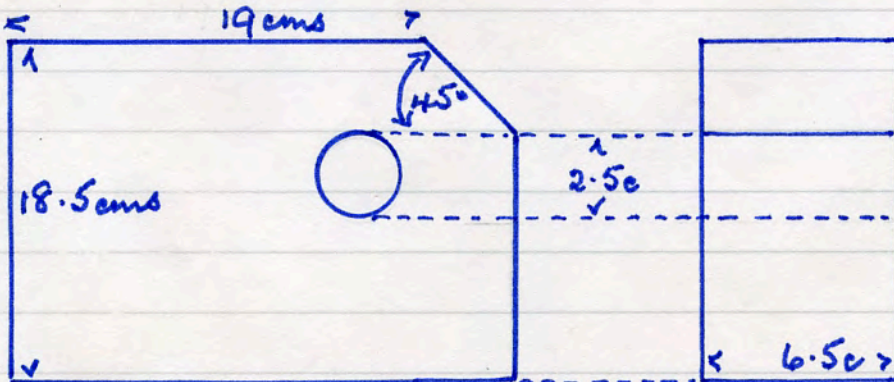

No name 37 RU red T.C 9 lbs
Acpton Mori dem. site 14. 7. '90

4688

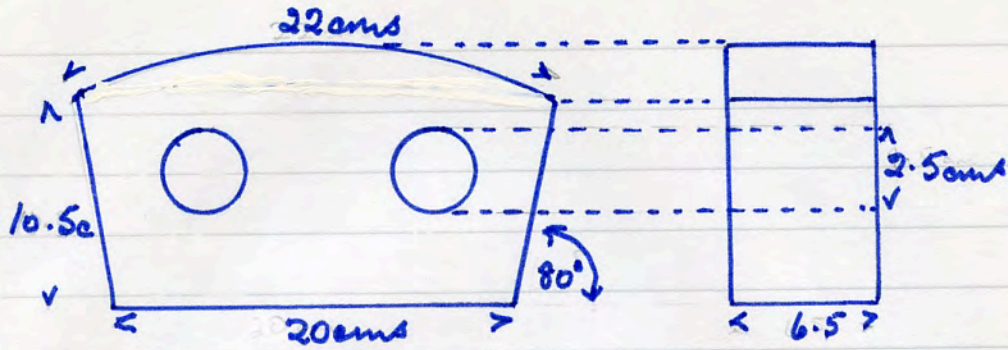

No name 645V red cambered brick 7 lbs
 rustic finish face edge. 2 x 2.5cm diam. perfs
 Acpton Mexi dem. site. 18. 7. '90

4689



No name 24.52 red brick 7 lbs
 2 x 2.5cm diam. perfs. Acpton Mexi dem. site
 18. 7. '90

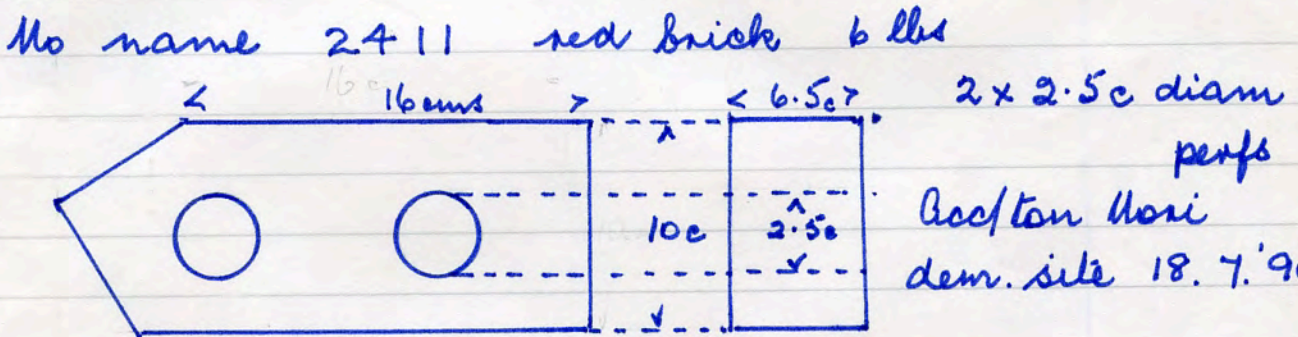

4690

No name 615V rebated red brick 6 lbs
 nosed edges.

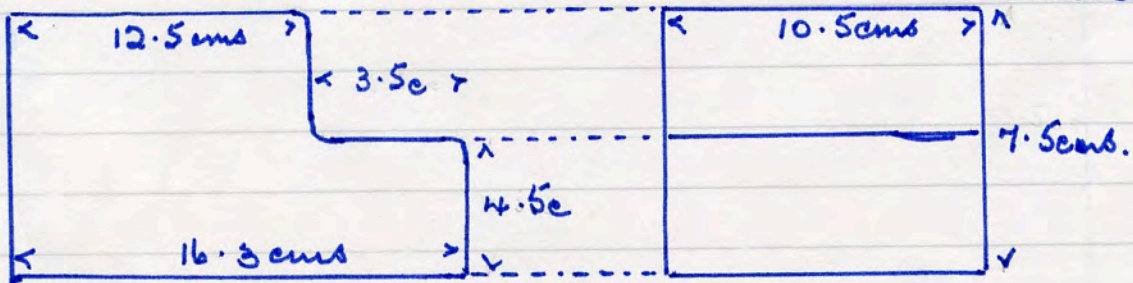

4691

Acpton Mexi dem. site 18. 7. '90

4692

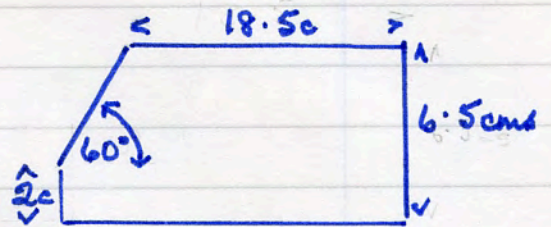
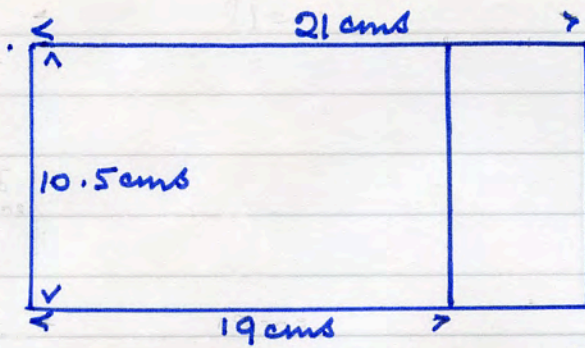

No name 14 R 2 red bricks 7 lbs.

Acpton Mori dem. site 18. 7. '90

No name 868 VC red brick 6 lbs

Acpton Mori dem. site 18. 7. '90

4693

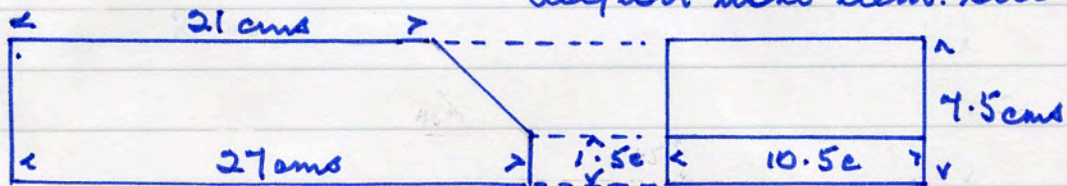

No name 14 R PA5 red T.C. square return 7 lbs

Acpton Mori dem. site 18. 7. '90

4694

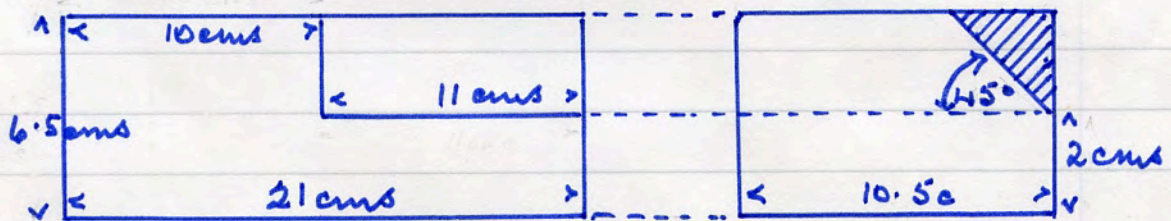

No name PL7 9H red T.C 3 lbs. nosed edges

4695

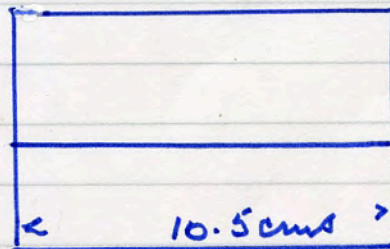
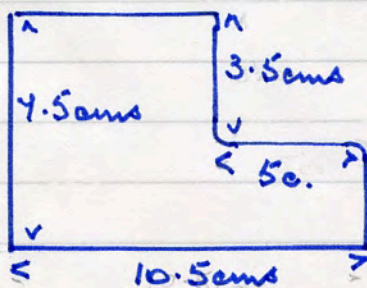

Acpton Mori dem. site 18. 7. '90

No name CTX red T.C 2 lbs

all corners eased

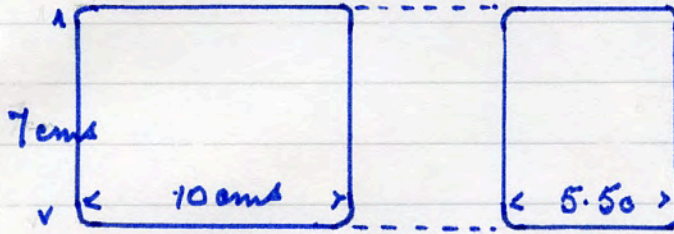

Acpton Mori dem. site
18. 7. '90

4696

No name. 93 H 9X

red T.C. 5lbs

Acpton Mori dem. site

18. 7. '90

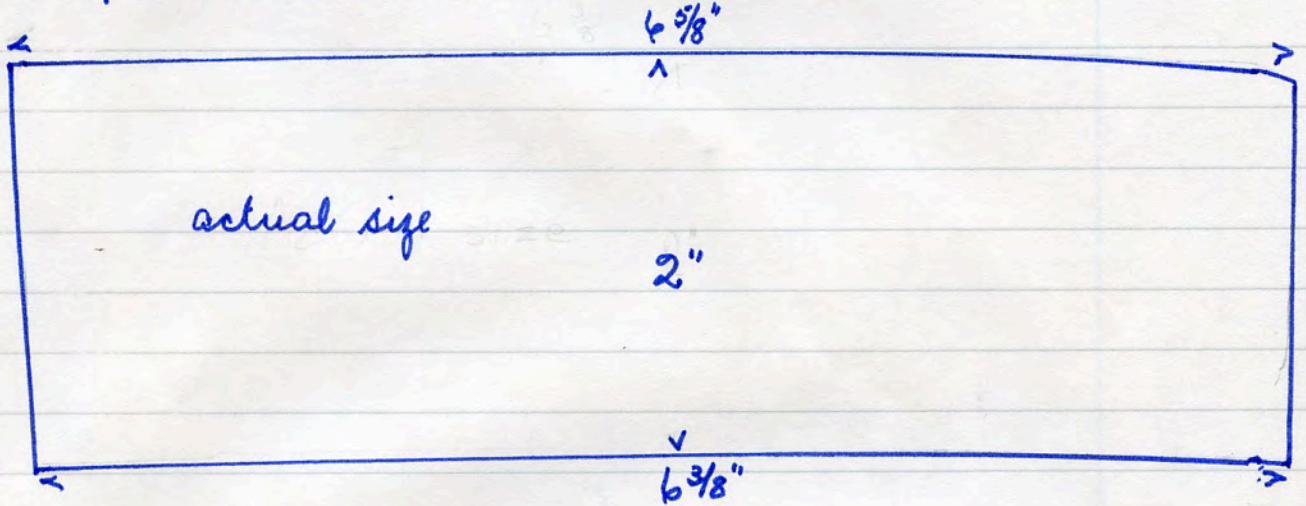

actual size

2"

4697

Manila Shovel Head

Wt 15.26

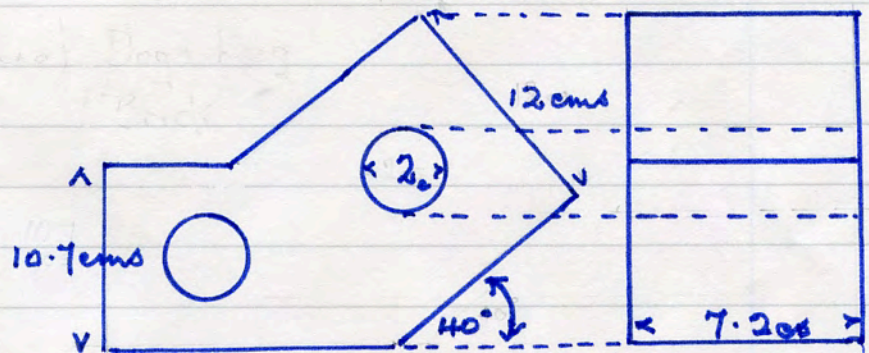

4698

No name. no number. special dog leg brick
6 1/2 lbs. red.

Acpton Mori dem. site 18. 7. '90

4699

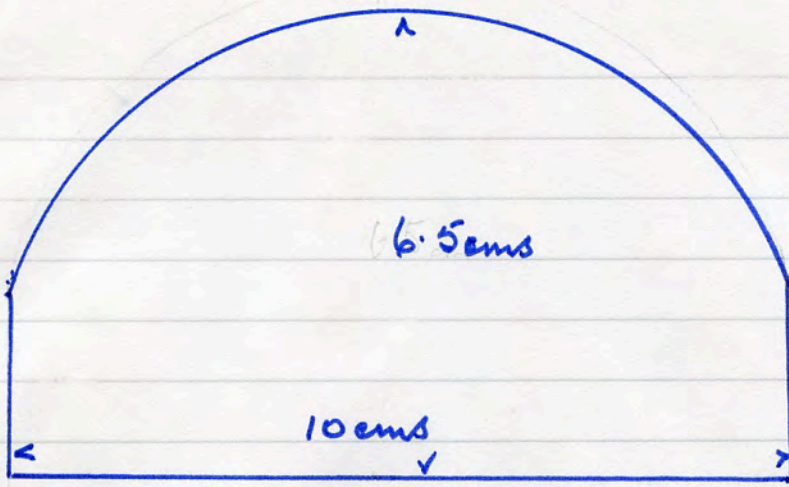

No name 231 42 red T.C. 6 lbs .21.5cms long.
 Wall coping for single brick thickness
 Acpton Mori dem. site 18. 7. '90

4700

No name 231 51 C Bowland Brown moulded wall
 16 lbs cap return

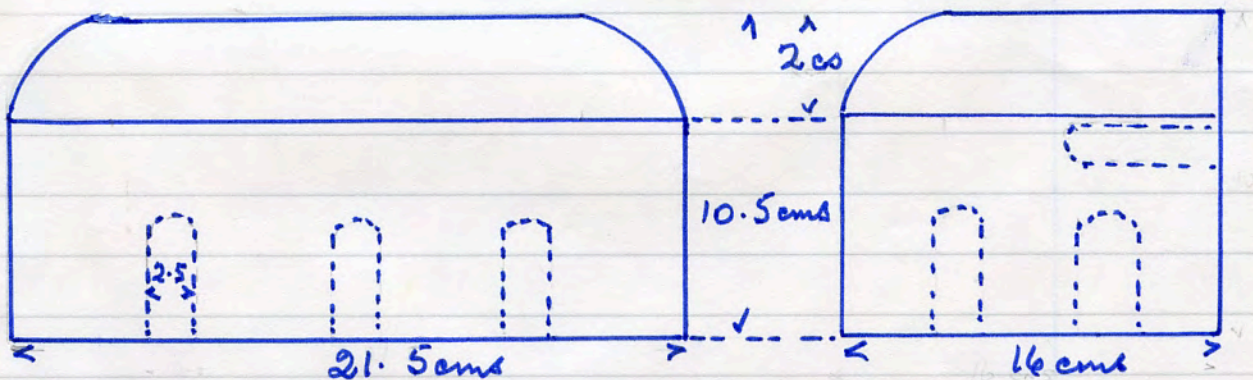

Acpton Mori dem. site 18. 7. '90

No name. no number. plain Bowland Brown tile.
 could be used as a closer. 4 lbs

4701

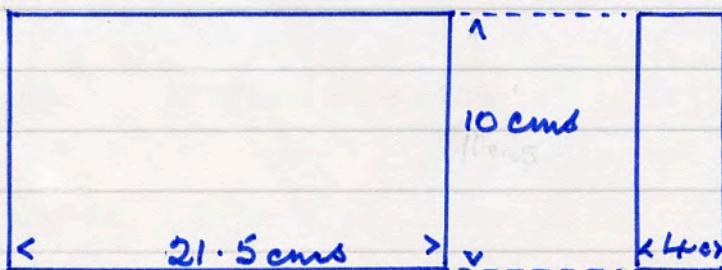

Acpton Mori
 dem. site 18. 7. 90

No name. 231 1C Bowland Brown nosed bricks 7lbs

4702

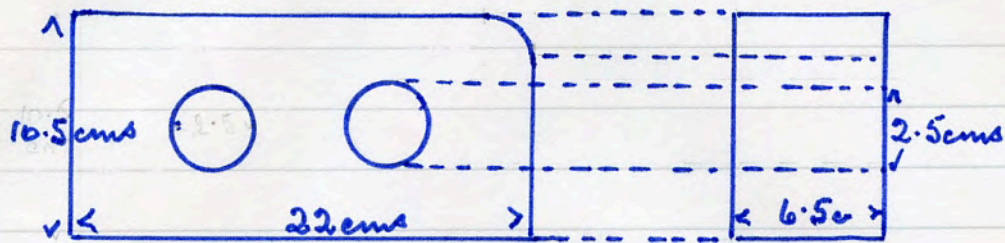

Acpton Mori dem. site 18. 7. '90

No name 231 2C Bowland Brown 1/2 bull nose
Acpton Mori dem. site 18. 7. '90 7lbs

4703

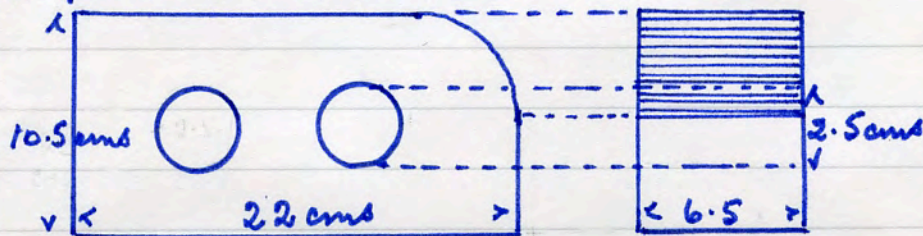

No name 23 62 Bowland Brown nosed capping 6lbs
Acpton Mori dem. site
18. 7. '90

4704

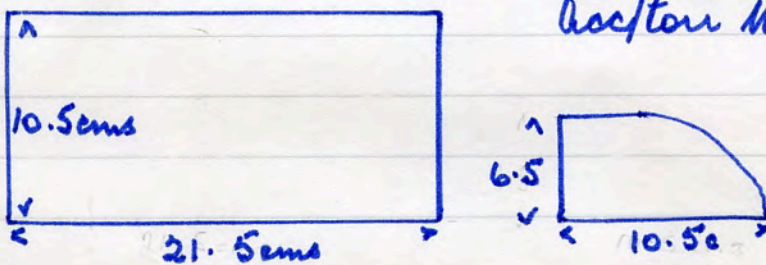

No name 2372 RD Bowland Brown. 7lbs
Acpton Mori dem. site. 18. 7. '90

4705

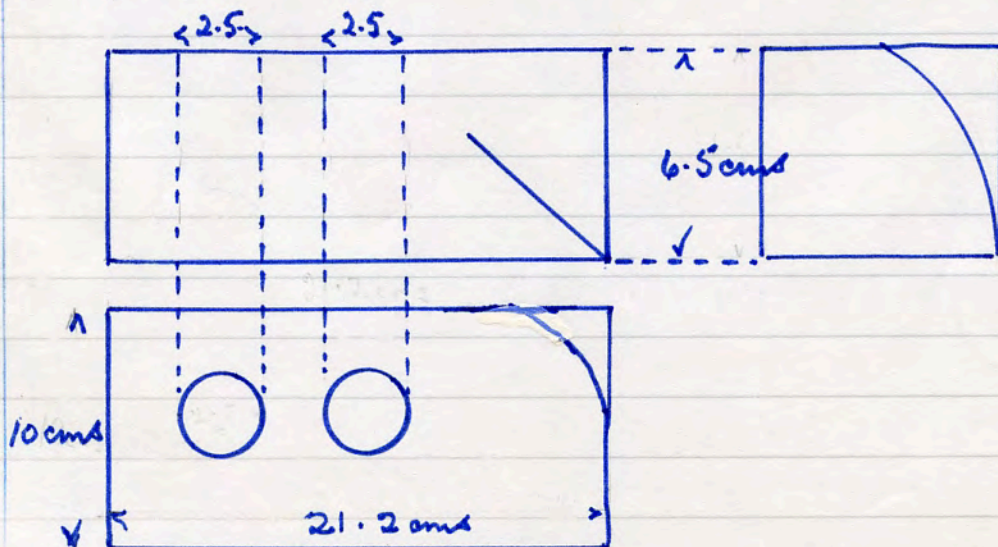

No name 978 VA red T.C. 21 lbs
 2 ends 1 edge 1 face side wise finished
 Acpton Maxi dem. site 18. 7. '90

4706

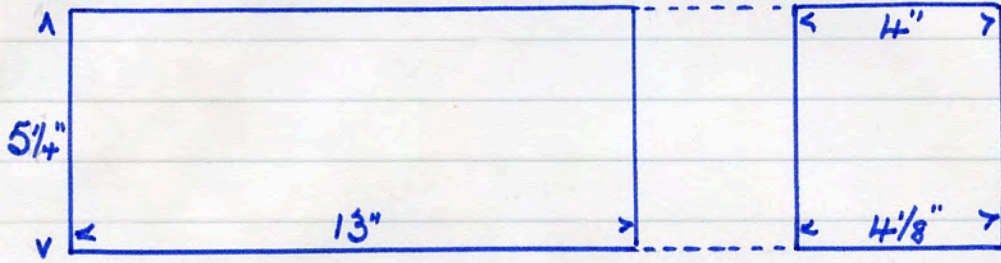

No name 12H red T.C. 8 lbs. 6" long.

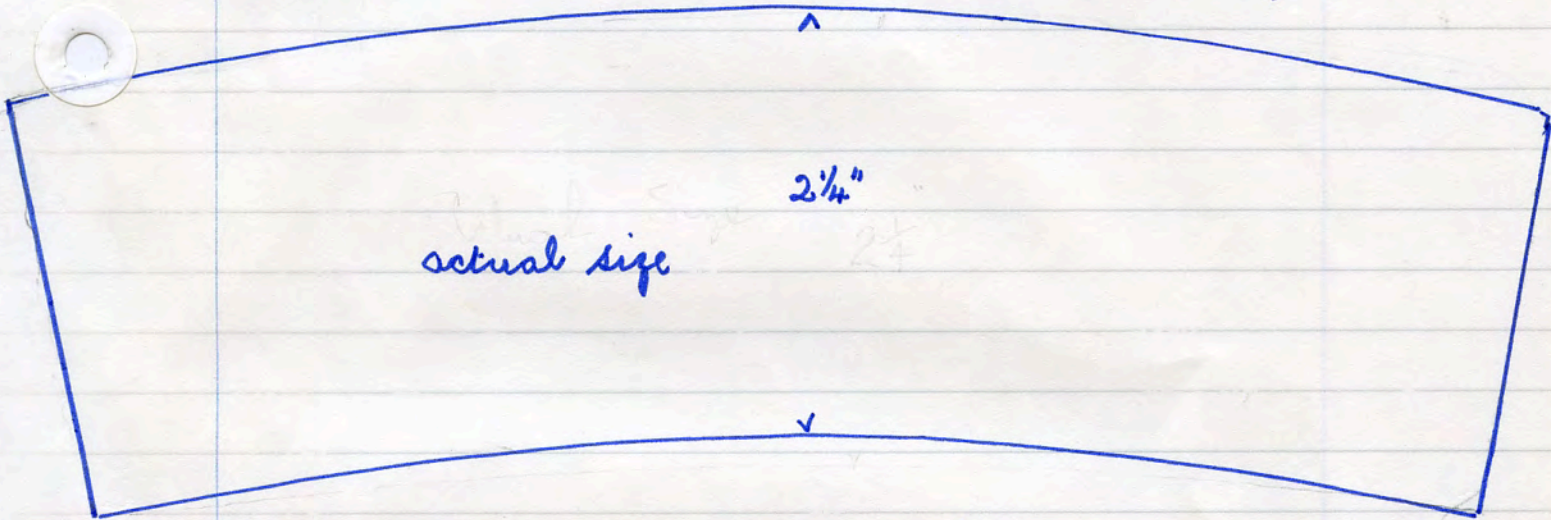

4707

Acpton Maxi dem. site 19. 7. '90

4708

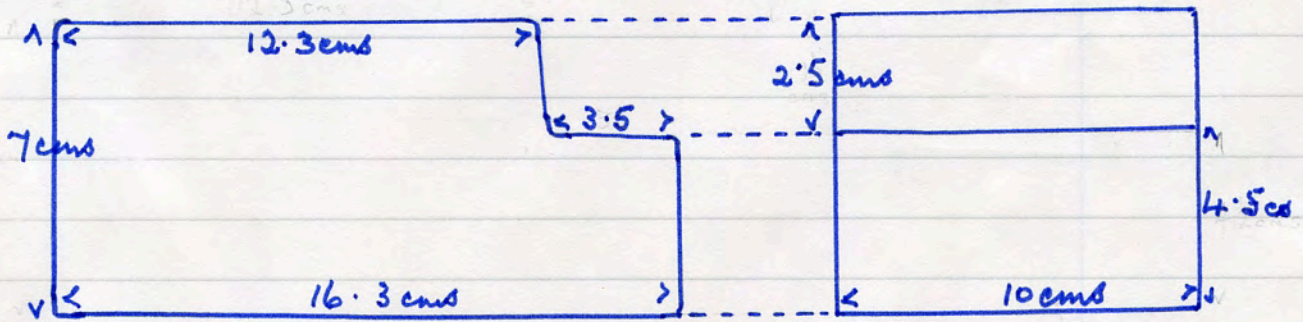

No name 615 V red T.C 6 1/2 lbs 10 cms long.
 Acpton Maxi dem. site 19. 7. '90

No name 60 PR wire cut rustic 5 lbs

Accpton Mori dem. site 19. 7. '90

4709

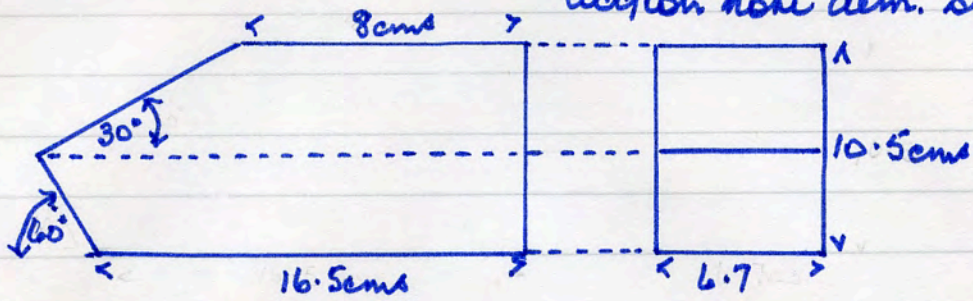

No name PN5 red T.C. 12 lbs

Accpton Mori dem. site 19. 7. '90

4710

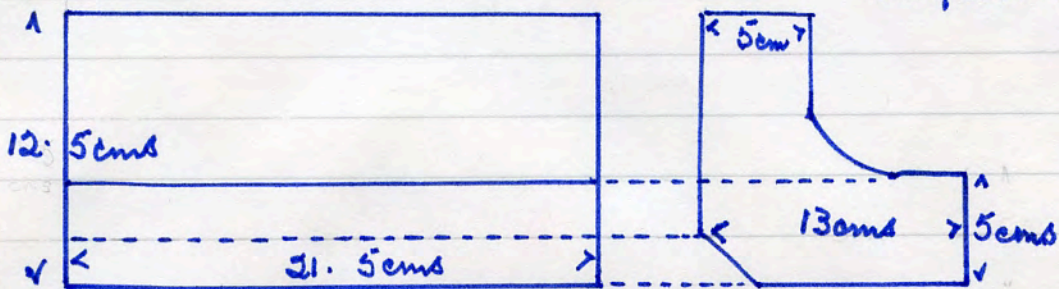

No name 1C1 red T.C 1/4 bull nose 8 lbs.

Accpton Mori dem. site 19. 7. '90

4711

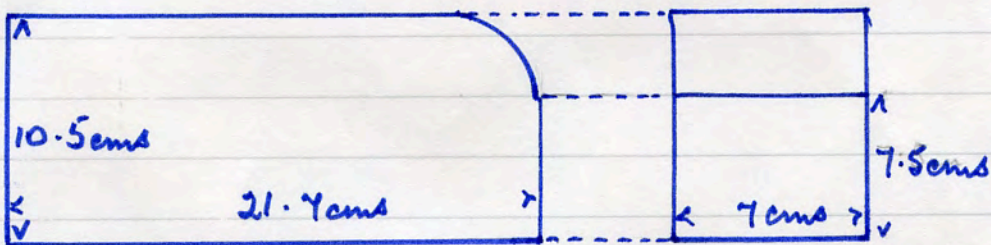

4712

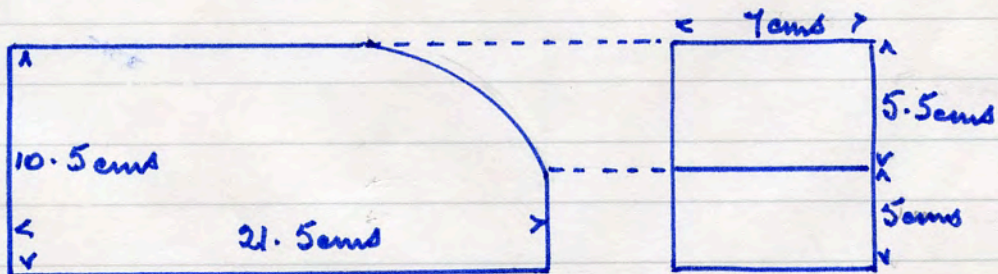

No name 1C2 red T.C 1/2 bull nose 8 lbs

Accpton Mori dem. site 19. 7. '90

No name 237 1LA red T.C. moulded mitre on edge 7 lbs

4713

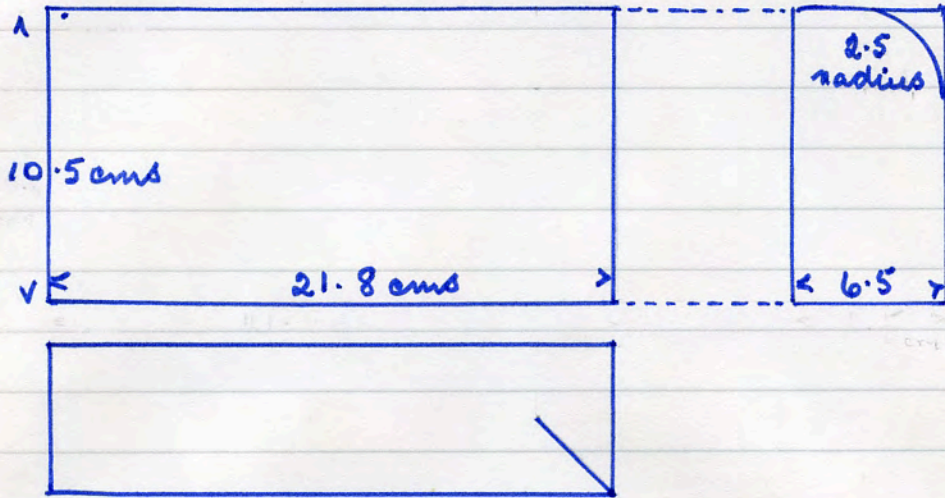

No name 237 1RA red T.C. moulded mitre on edge 7 lbs

4714

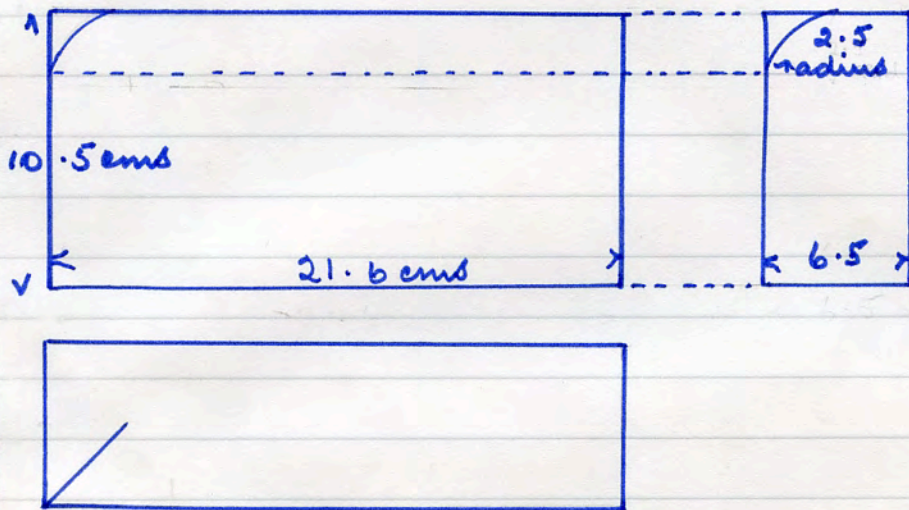

No name 17 5. red T.C. 7 lbs

4715

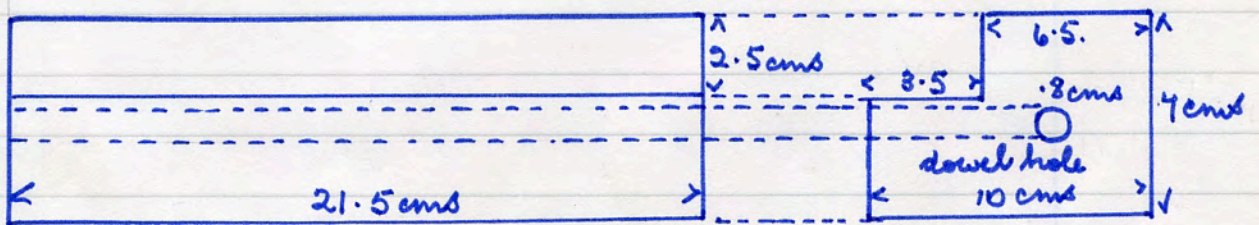

All above - Accpton Mori dem. site 19. 7. '90

No name 902VB red T.C. 14 lbs

4716

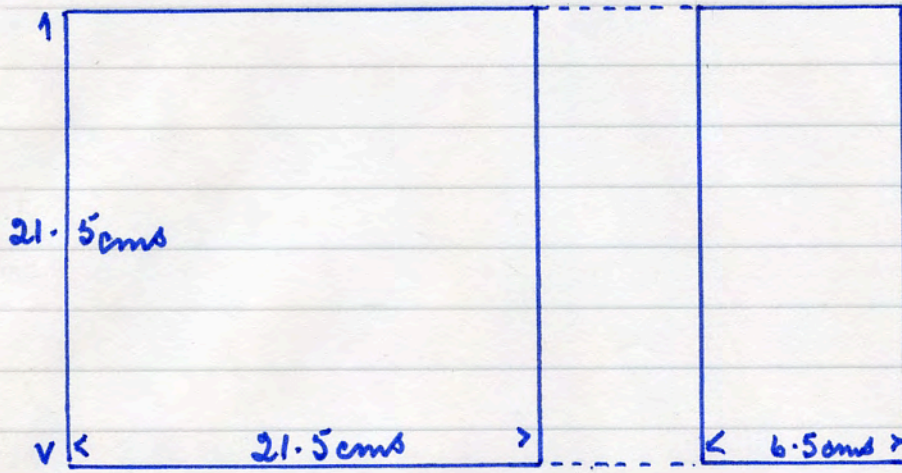

No name. no number red T.C. 7 lbs

4717

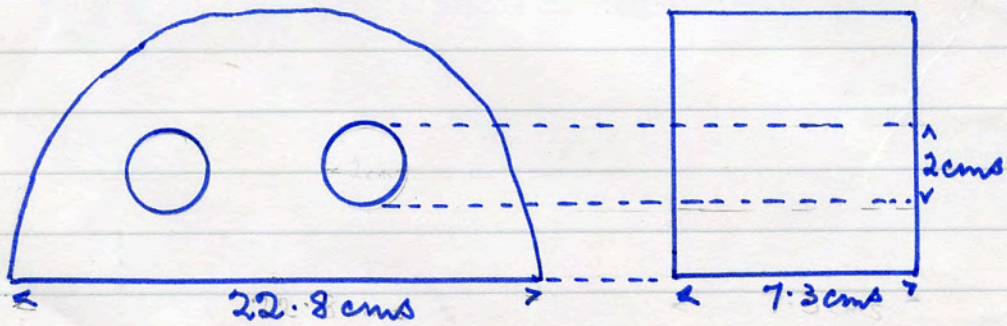

No name 30 red T.C. 7 lbs

4718

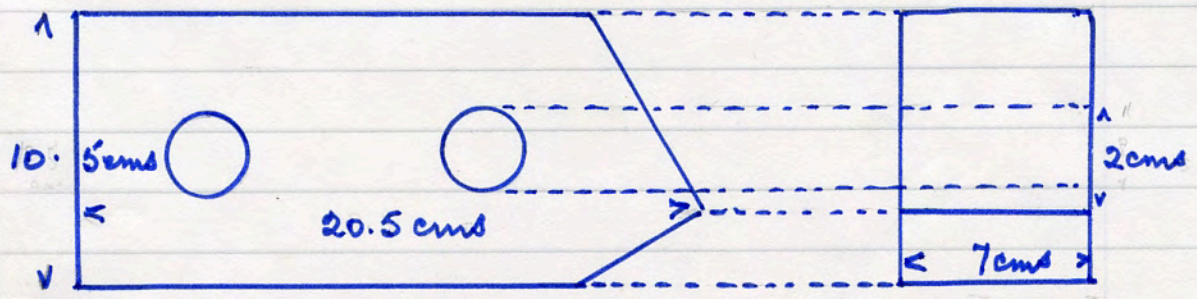

No name 30-5 red squint brick 6 lbs

4719

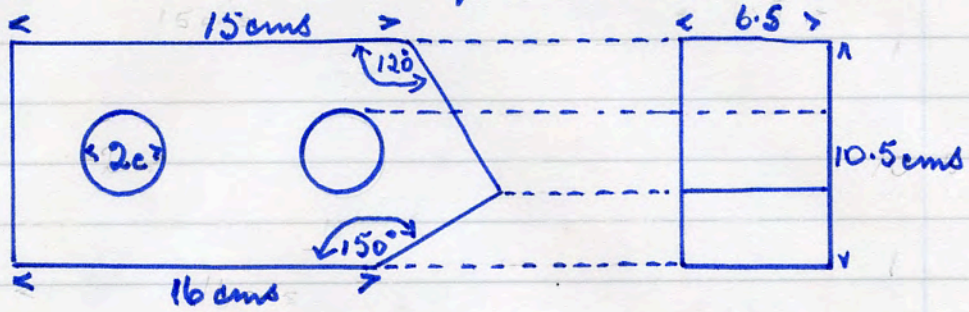

No name 45-5 red dog leg brick 7 lbs

4720

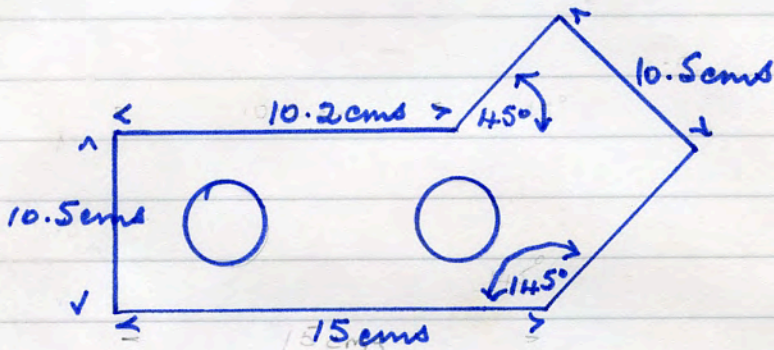

No name 21 R 4 red special shape brick 7 lbs

4721

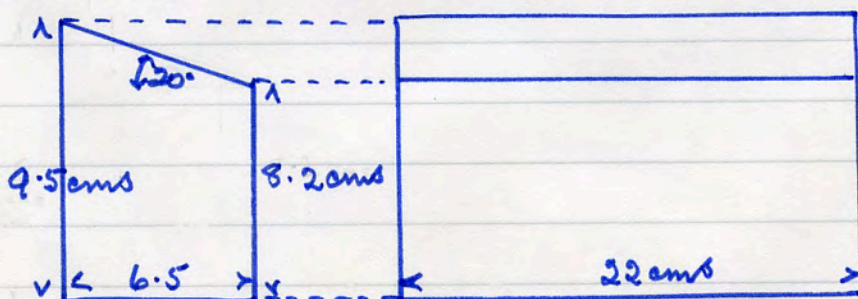

No name 84 9U red special shape brick 6 lbs

4722

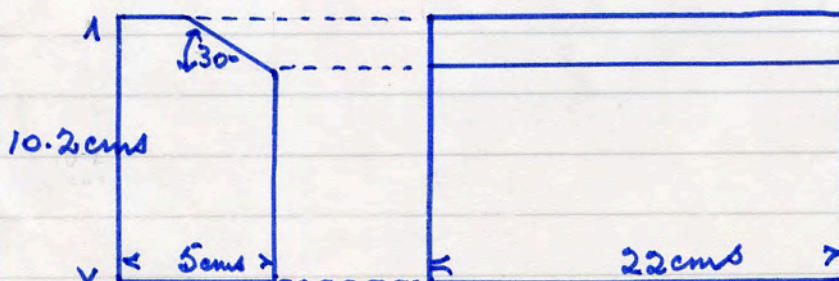

All above - Accpton Mori dem. site 19. 7. '90

No name C 2472 C Bowland Brown wall cap return

14 lbs.

4723

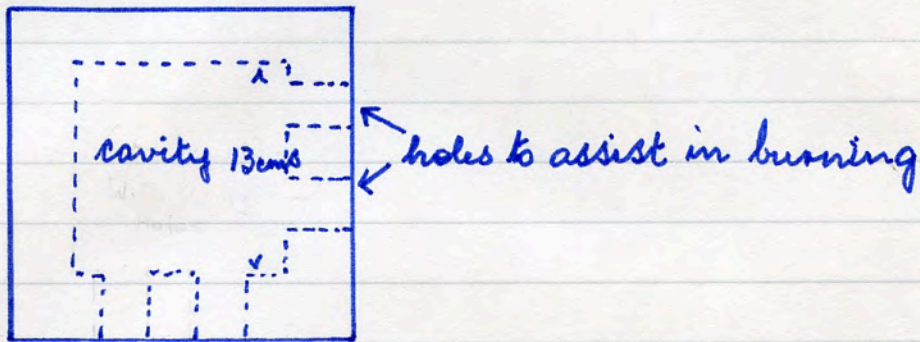
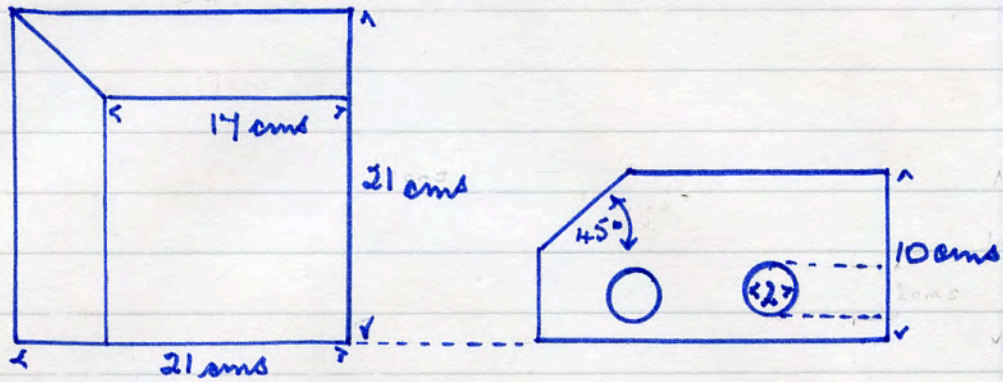

No name. 2461 XC Bowland Brown wall cap - internal & external return

16 lbs

4724

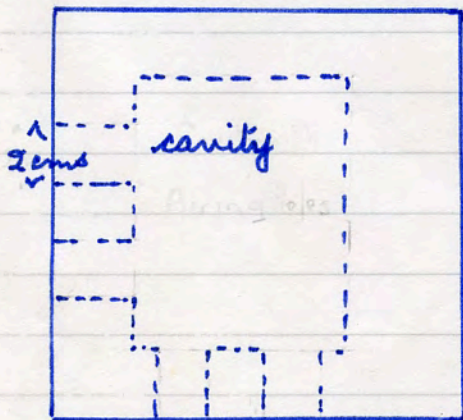
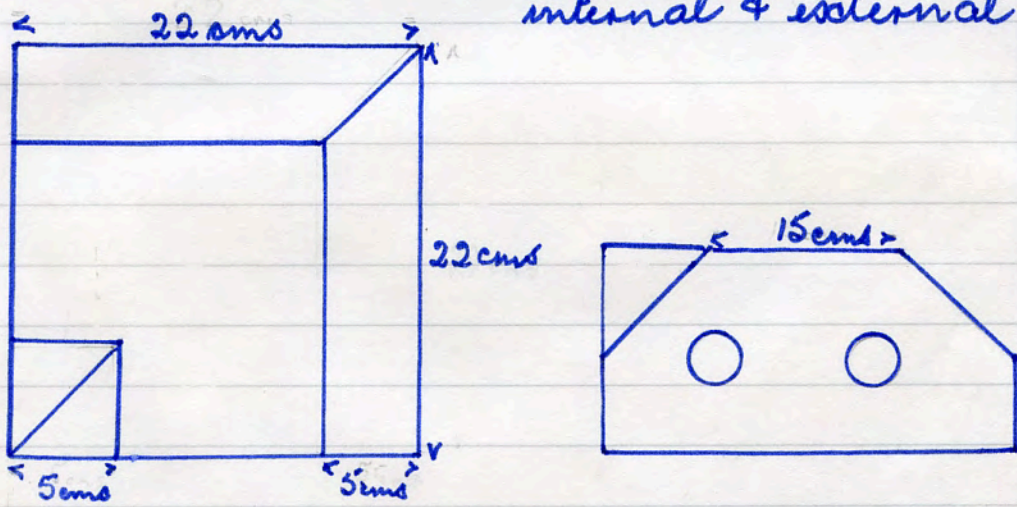

Both above - Accpton Mori dem. site - 20. 7. '90

H725

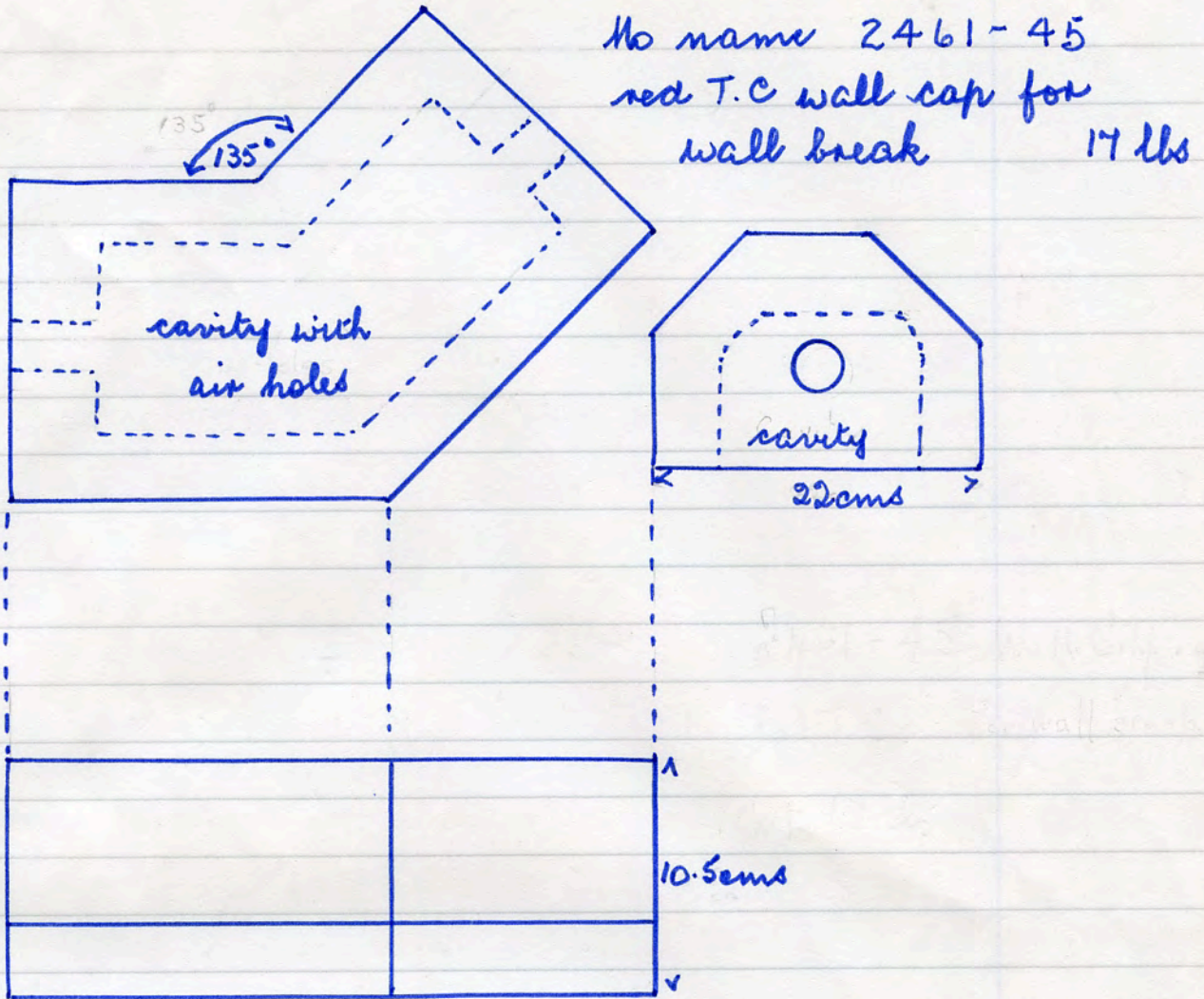

H726

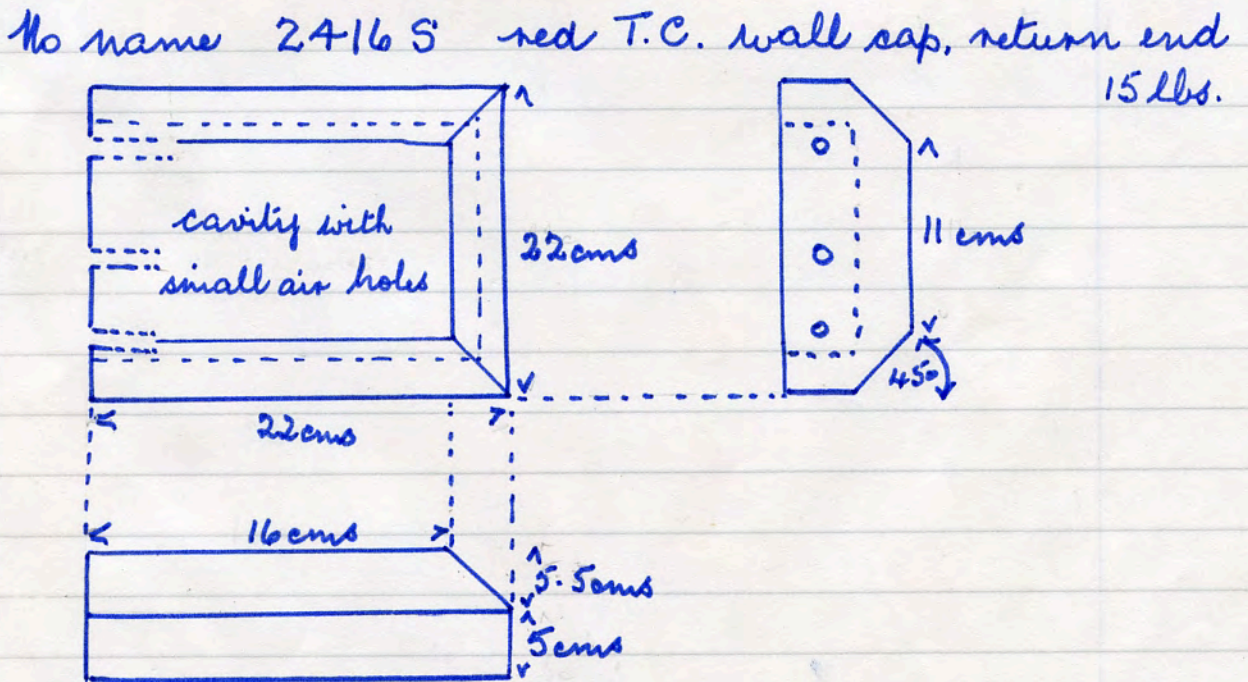

Both above - Accpton Mori dem. site 20. 7. '90

No name. 251 2RB rustic brick for jamb work 7 lbs

4727

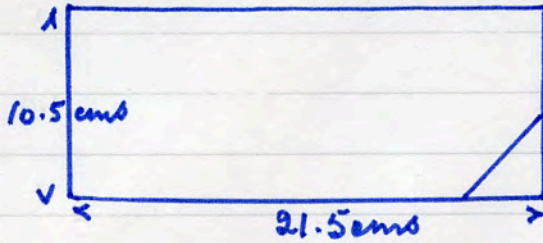

rustic 2 end 1 face edge

4728

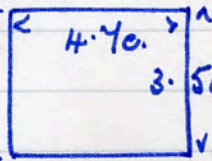
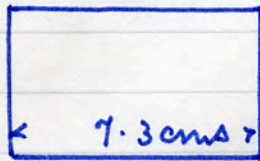

No name, no number
special small closer brk.
red T.C. 1 lb.

4729

No name EX7 small piece red T.C 1 1/2 lbs.

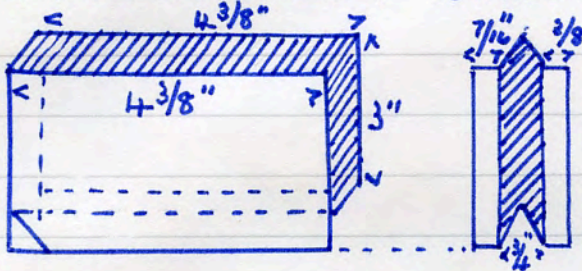

4730

No name CP2 red T.C. 5 1/2 lbs

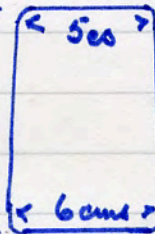
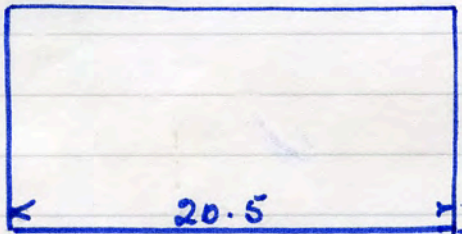

GIBBONS (DUDLEY) SPECIAL fire brick from Acc. B + J. Kilns

9" x 4 1/2" x 4 1/2"

10 lbs

letters stamped

4731

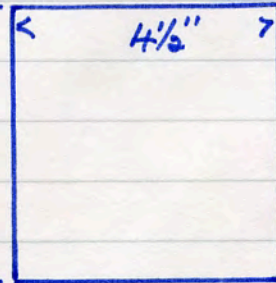
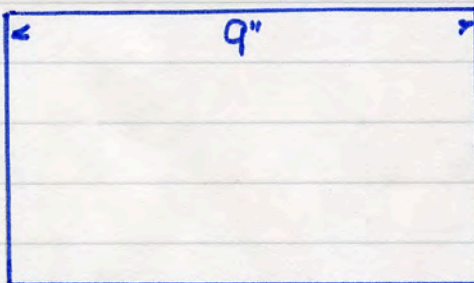

4 1/2"

All above - Acc/ton Mori dem. site 23. 7. '90

No name PP7 red T.C trough · 15lbs
length 8³/₄"

4732

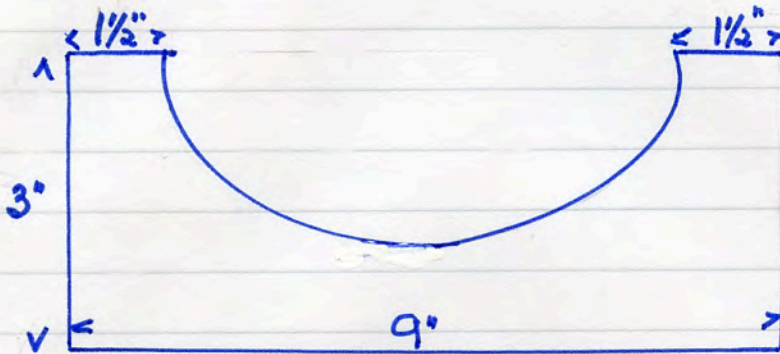

No name 37 RU red T.C. 9lbs

4733

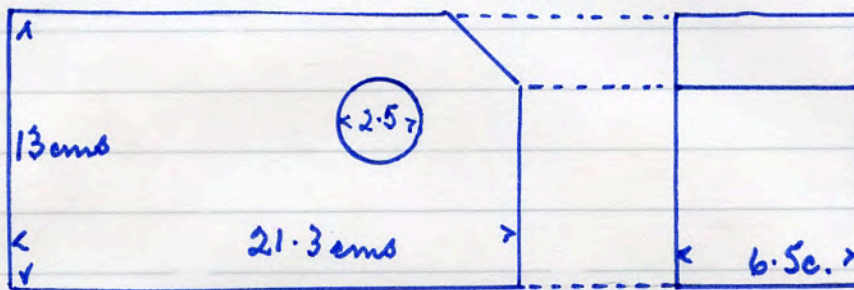

No name 2937 red T.C (broken) 28 x 2mm diam perfs
9lbs number on edge in each row.

4734

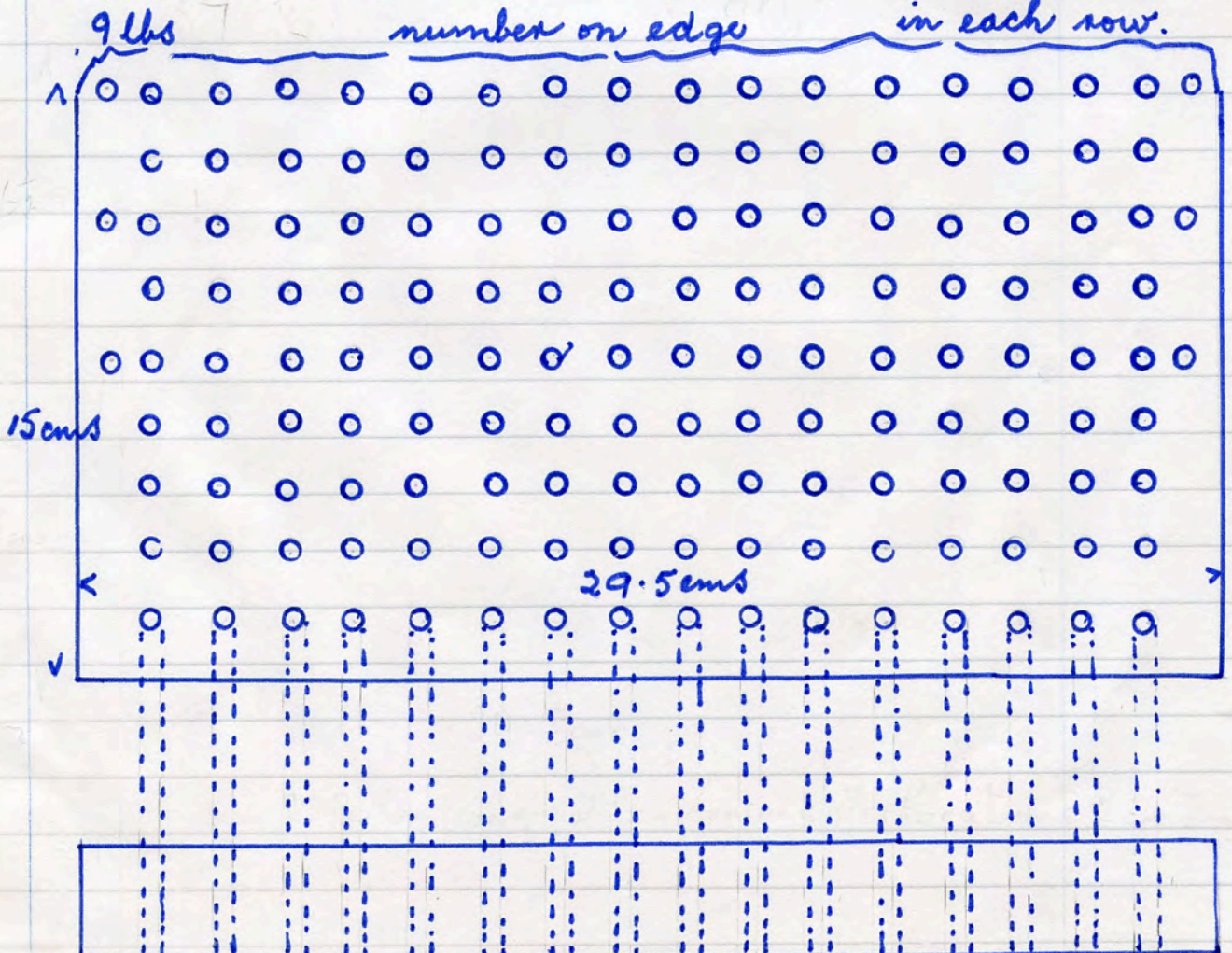

All above - Boston Hori dem. site 23. 7. 90

4735

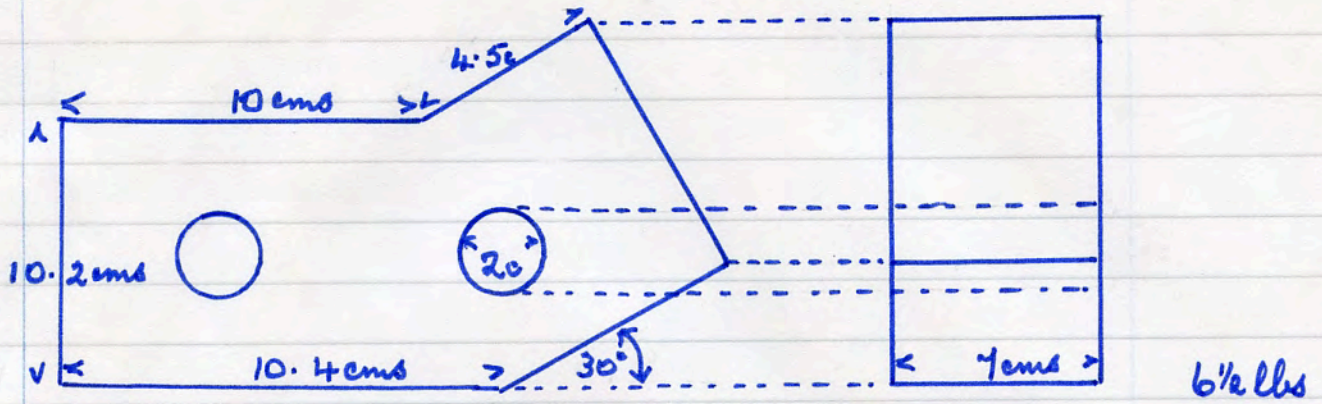

No name 30 red dog leg brick 2 x 2 cm diam perfs.

4736

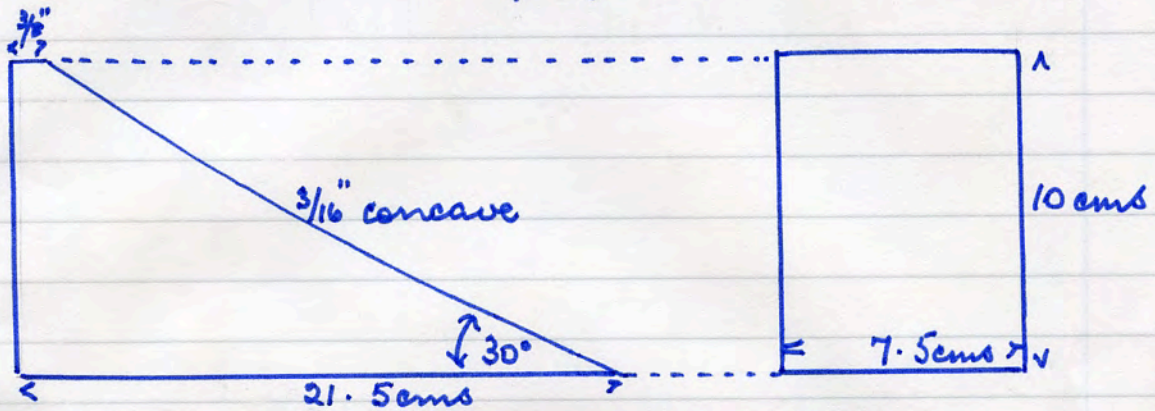

No name 14 P 135 red T.C. 5 lbs

No name 7 FBB red T.C. 2 lbs

4737

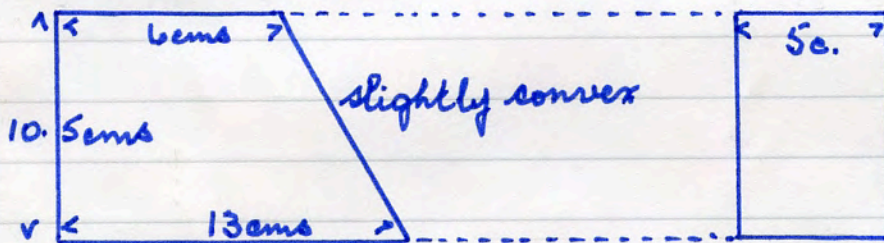

No name 450 376 red T.C. 5 lbs

4738

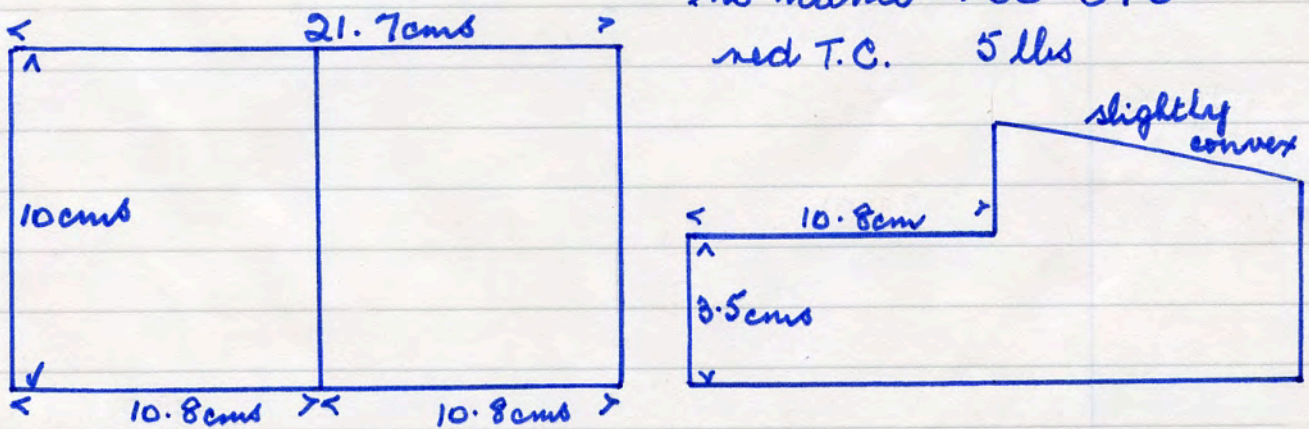

All above - Acpton Mexi dem. site 24. 7. '90

4739

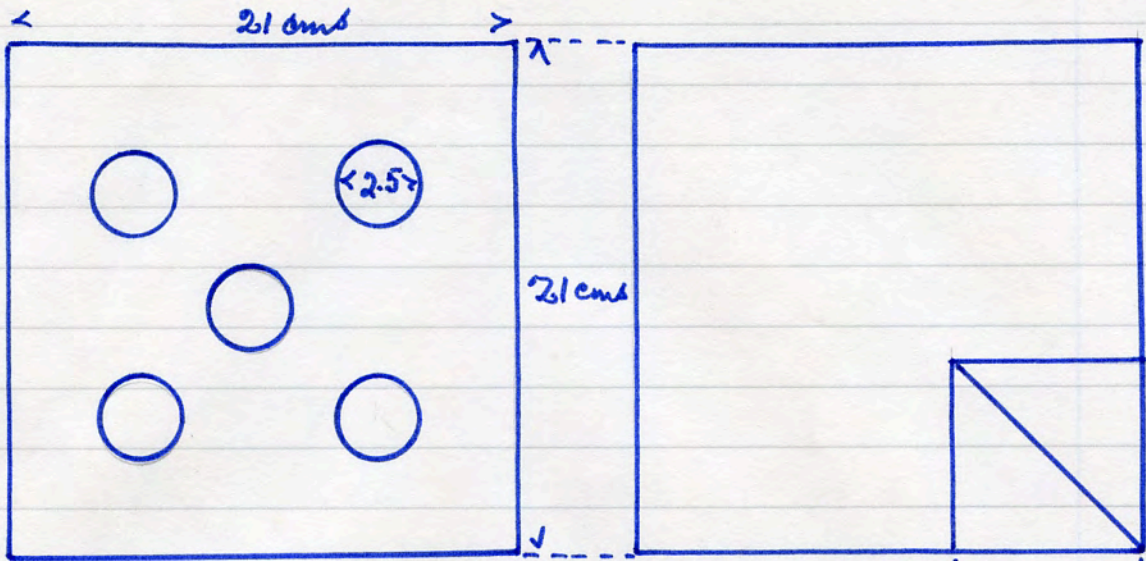

No name 231 041 D
 Bowland Brown mitred return
 21 lbs

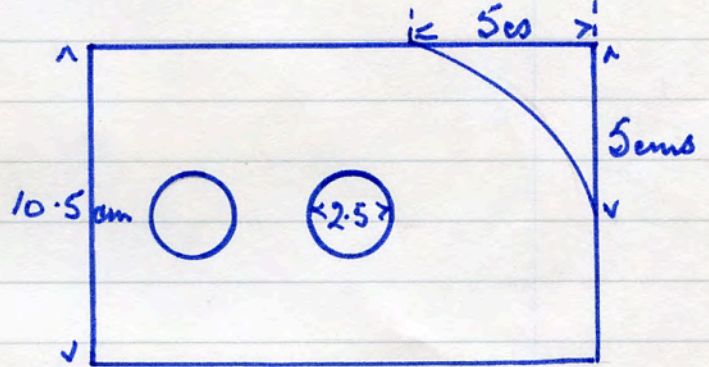

4740

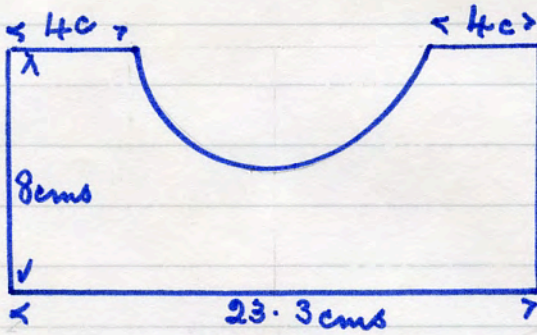

No name PP75 red T.C
 7 lbs length 22.5 cms

Both above - Acception Mori dem. site 25. 7. '90

No name 53 R1 red T.C. 8 lbs.

4741

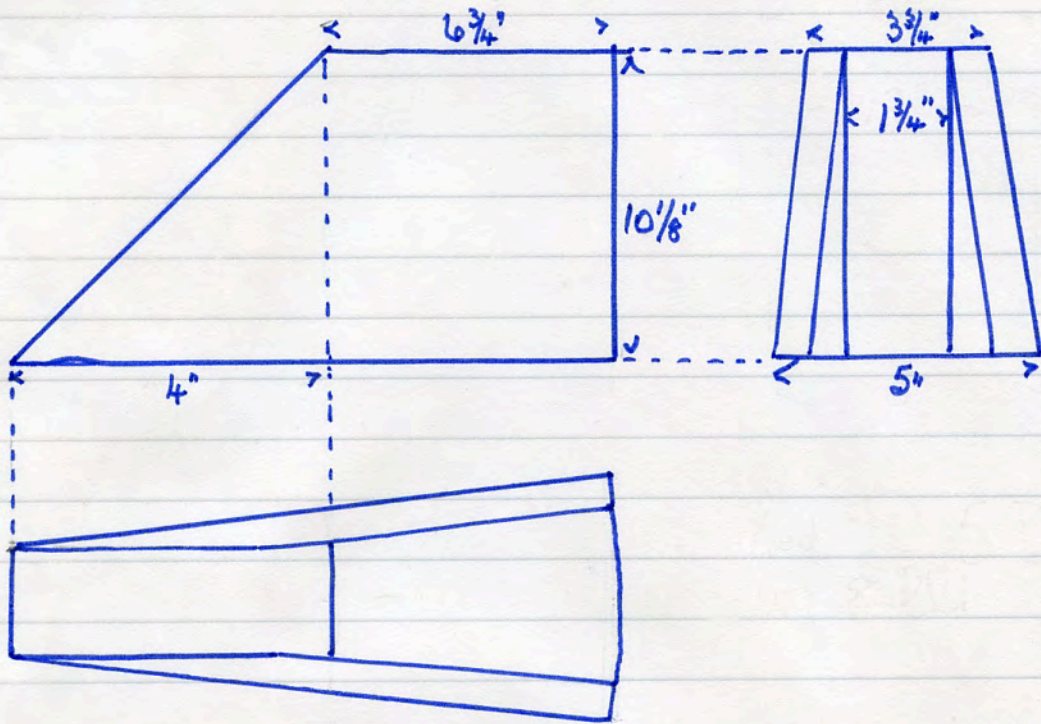

No name 2AM red brick 8 lbs

4742

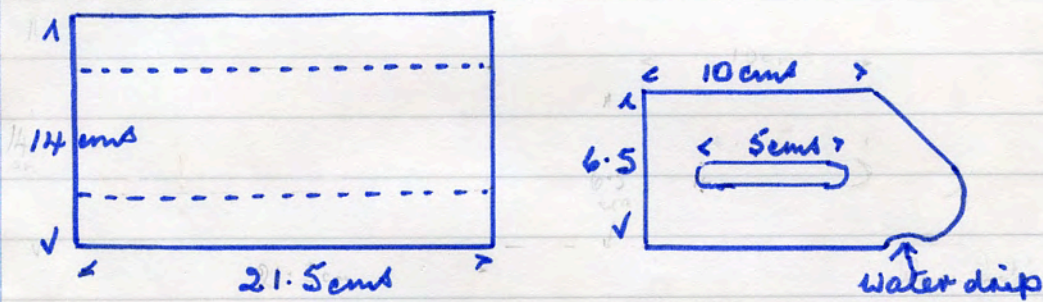

No name 2AM Bowland Brown 7 1/2 lbs.

4743

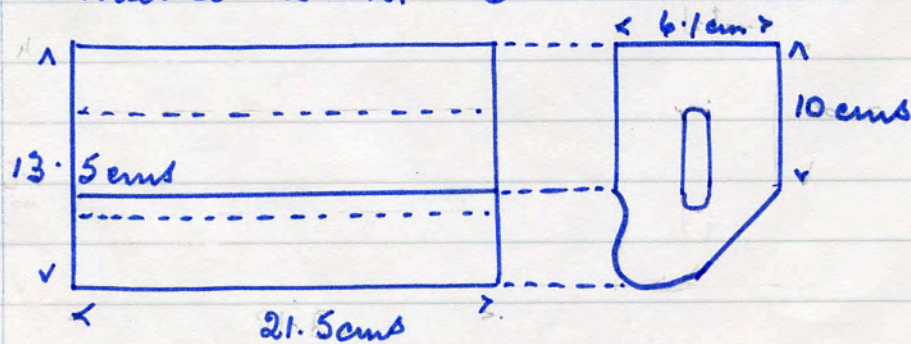

All above Acpton Noni dem site. 25. 7. '90

4744

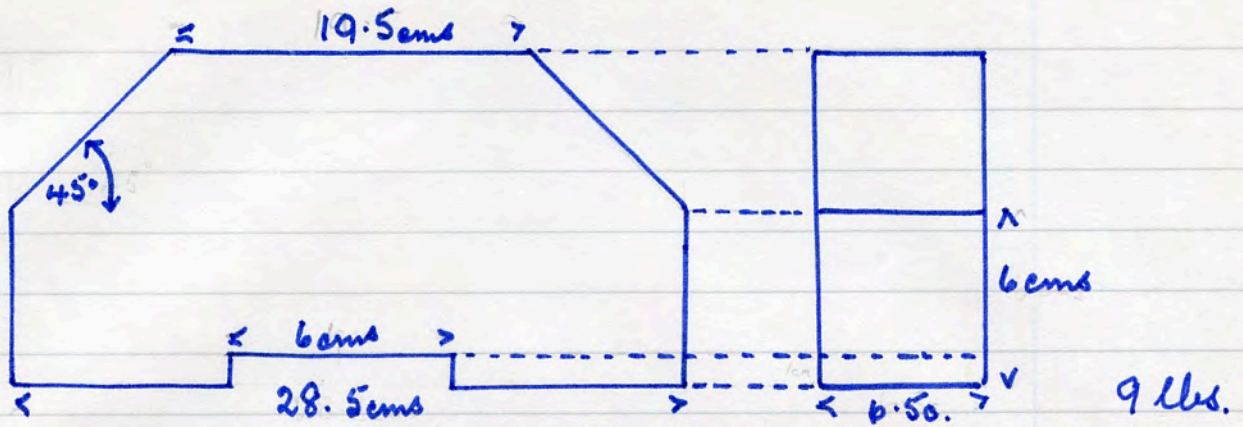

No name, no number. wall cap in red brick shale

No name 31 R 15 red gauged blk with T.C. finish 6 1/2 lbs

4745

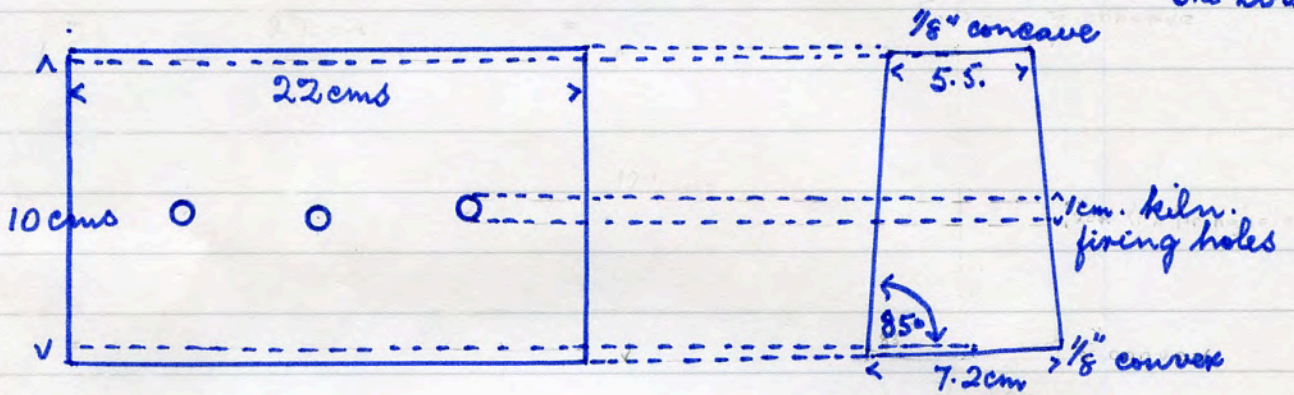

4746

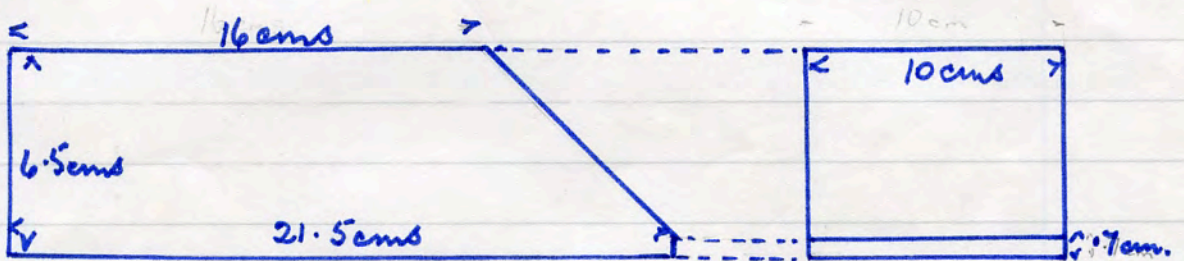

No name 25 1A red brick shale wire finish 6 1/2 lbs

4747

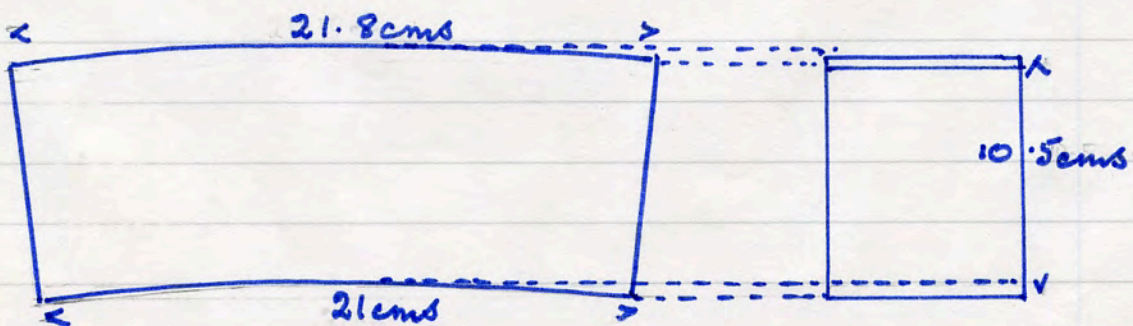

No name 8 red brick shale. wire finish 8 lbs

All above, Acclton Mexi dem. site 35. 7. '90

No name CSO red brick shale wise cut

8 lbs

4748

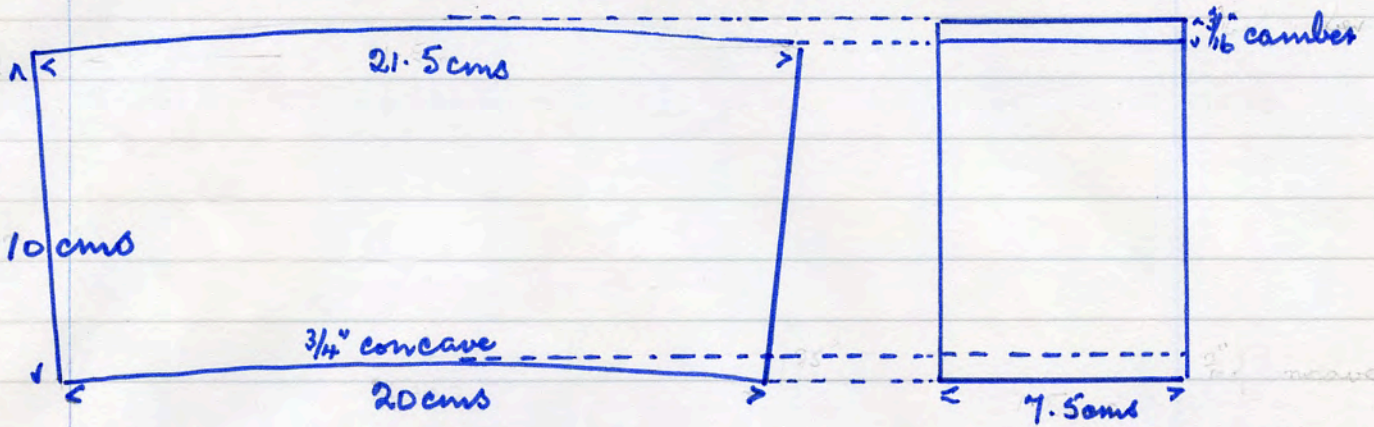

No name 2AH red brick shale wise cut

7 1/2 lbs

4749

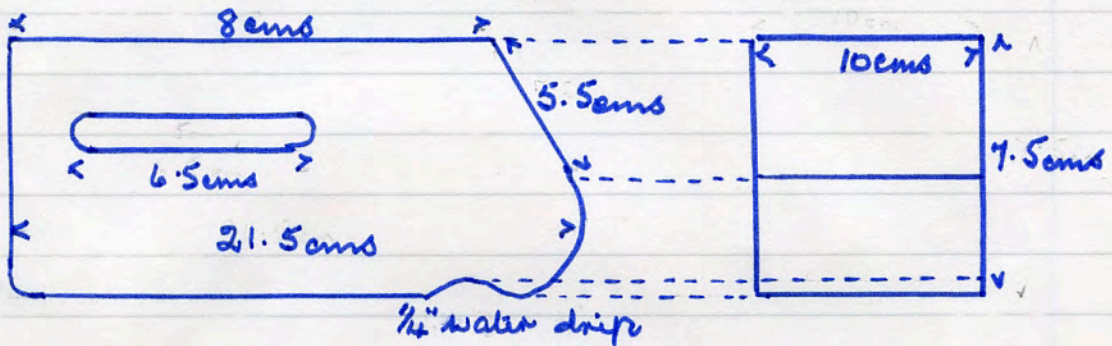

No name 45-7 red brick shale squint wise cut 8 lbs

4750

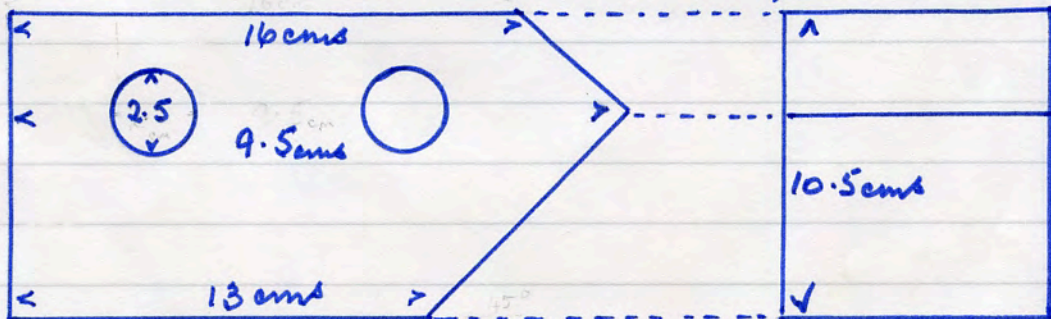

No name 537A red brick shale wise finish 7 lbs

4751

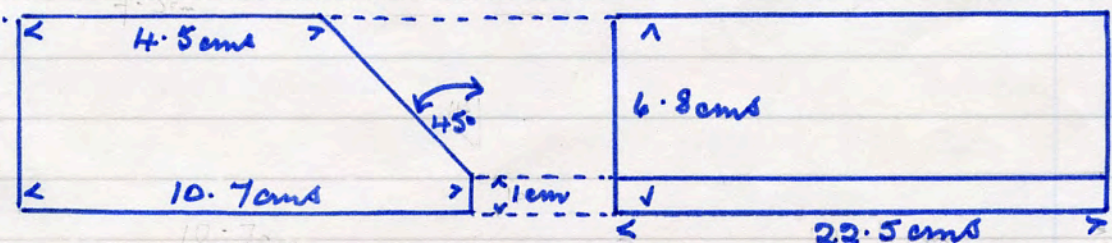

All above - Acceptor Hari dem. site 25. 7. 90

4752

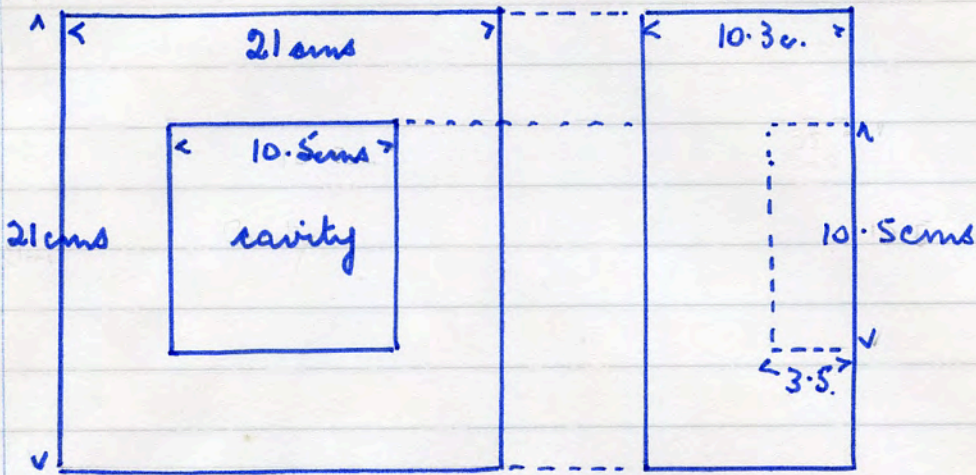

No name 284 T 23 square cap, no decoration
 red brick shale T.C finish 19 lbs

4753

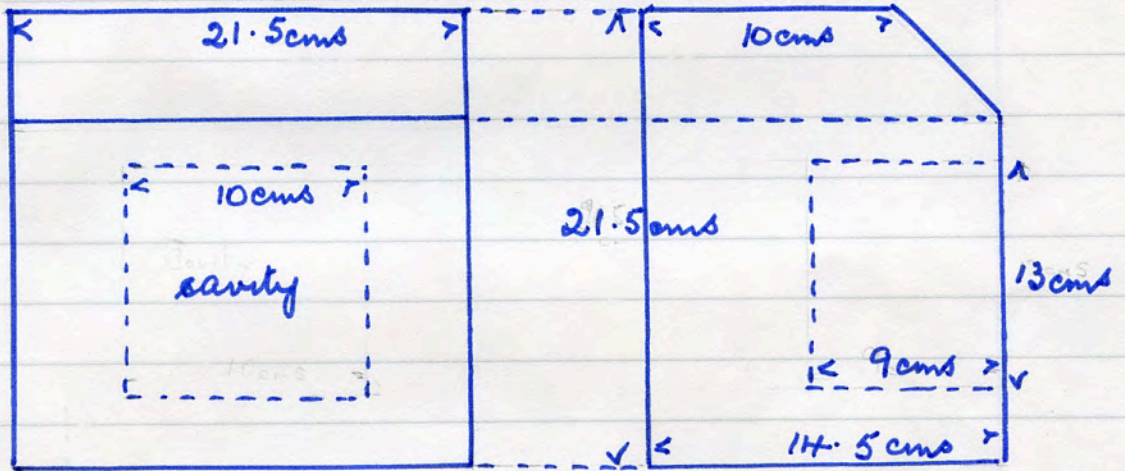

No name 284 T 7 square wall surround 26 lbs
 red brick shale T.C finish 1 face side

4754

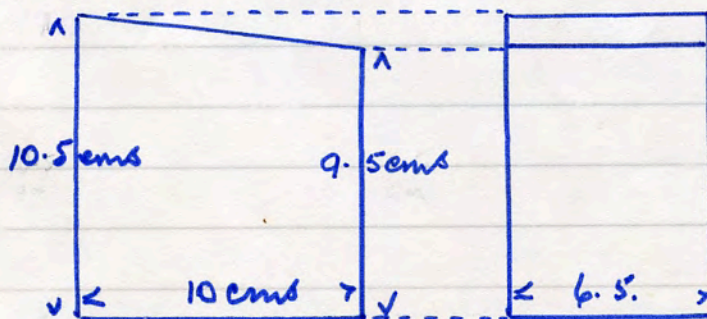

All above - Acc'ton Mori dem. site 26. 7. '90

4755

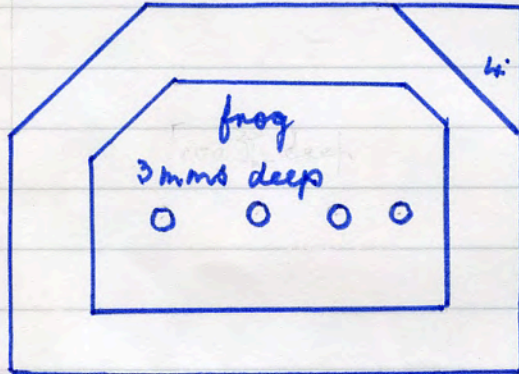
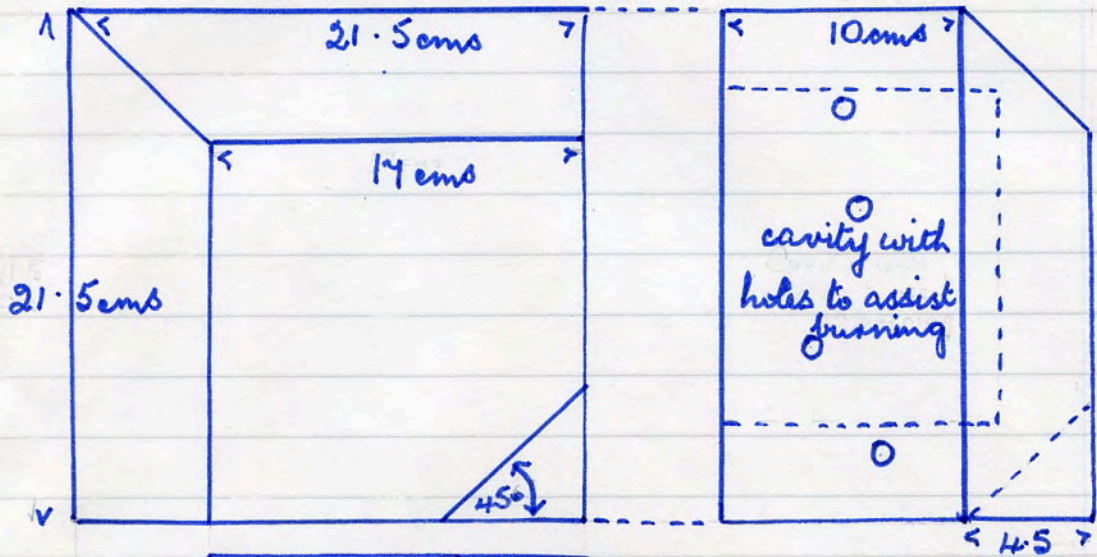

No name 284 T 26
 red brick shale
 T.C finish face side
 22 lbs

4756

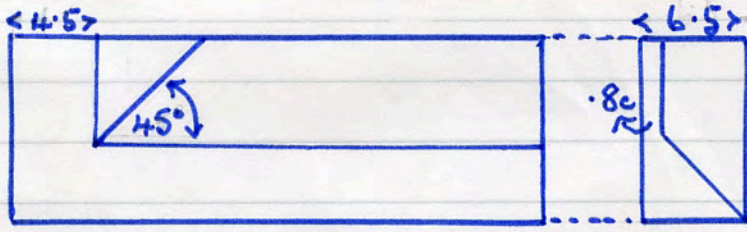

No name. 254 IRA
 red. wire finish
 6 1/2 lbs

4757

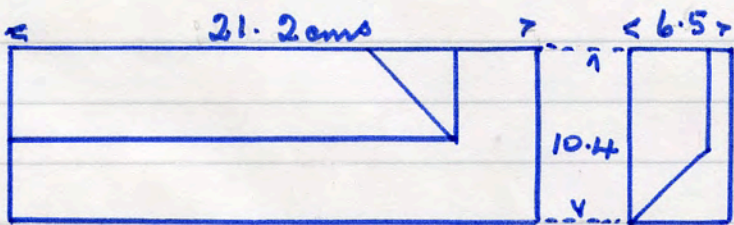

No name. 254 1L
 red. wire finish
 6 1/2 lbs

All above - Acceptor No. 1 dem. site 26. 7. '90

No name 263 TA red from brick shale. wire run 5 lbs

300
4758

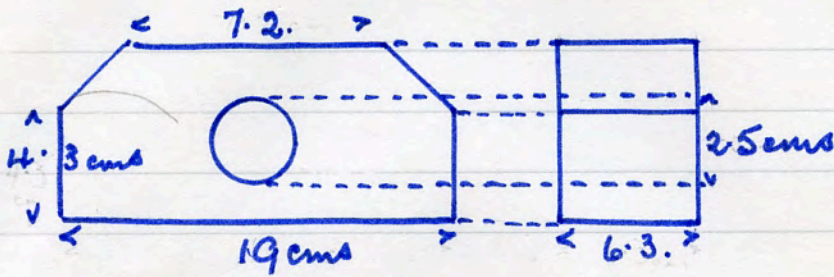

No name 284 T5 red from brick shale. wire run 7 1/2 lbs

4759

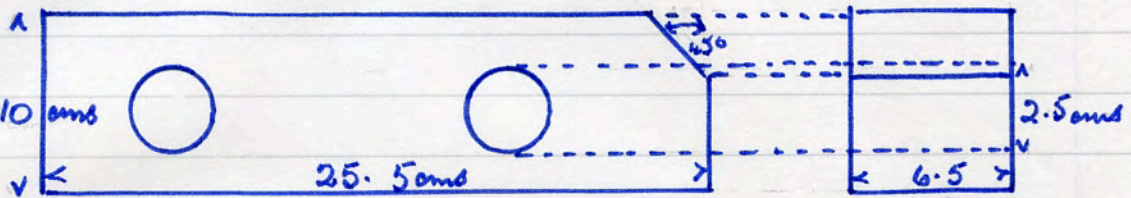

No name 862 Y red from brick shale T.C. finish 19 lbs

4760

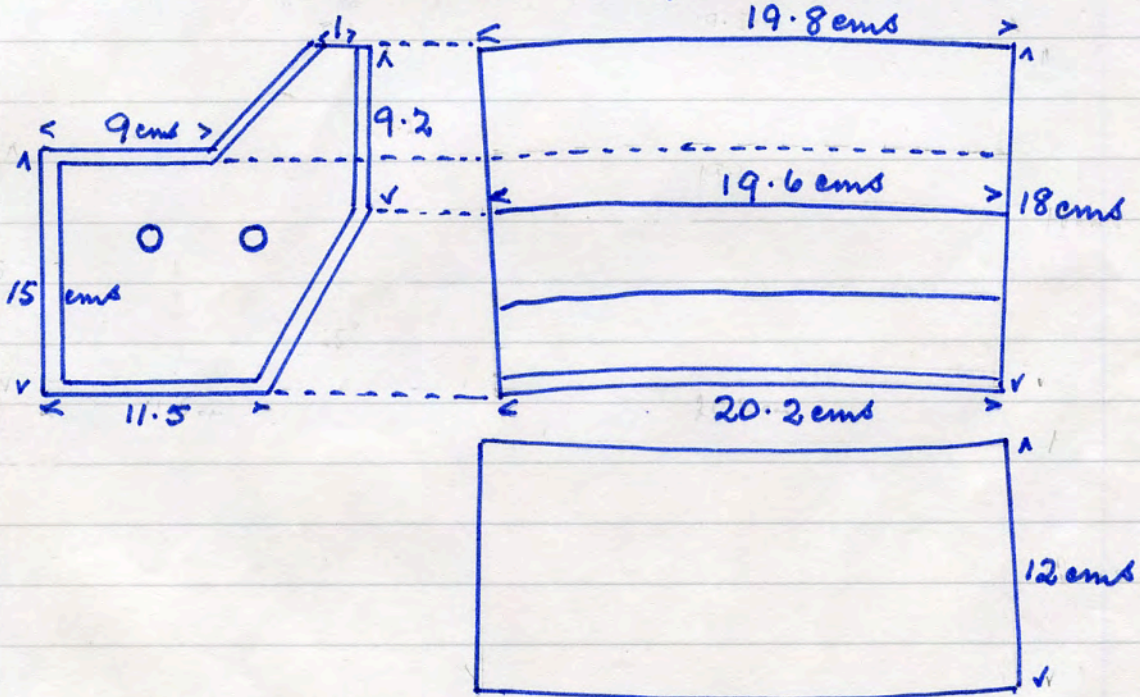

No name 769 YH red T.C finish.
external corners to rebate $\frac{1}{4}$ " round.

3 1/2 lbs

4761

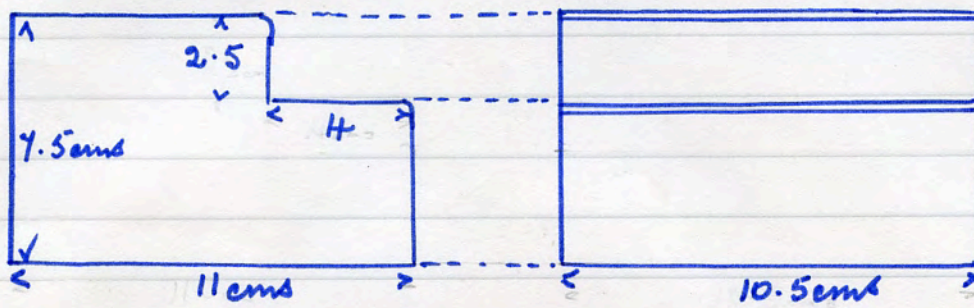

No name 39 RJX red T.C. tile

5 lbs

4762

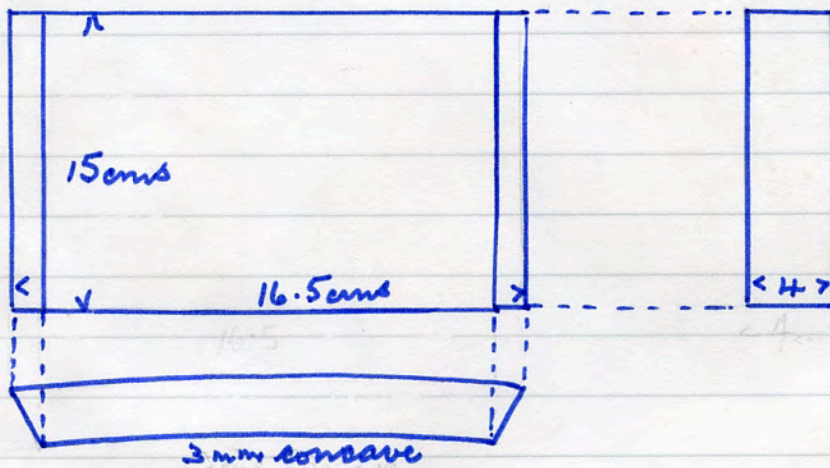

No name 2462 FE red T.C.

7 lbs

4763

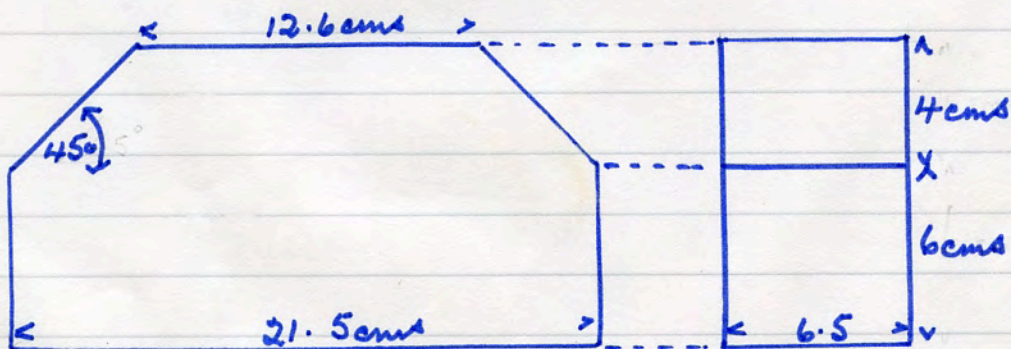

All above - Acpton Mori dem. site 26. 7. 90.

No name 39 RK red T.C. 3lbs

4764

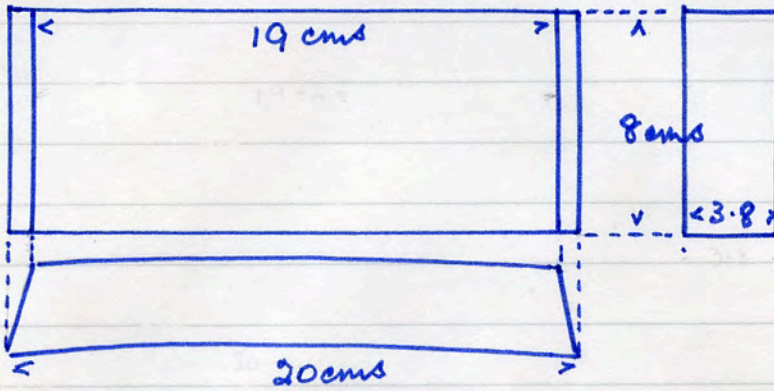

No name 250 TBR red T.C. 7lbs

4765

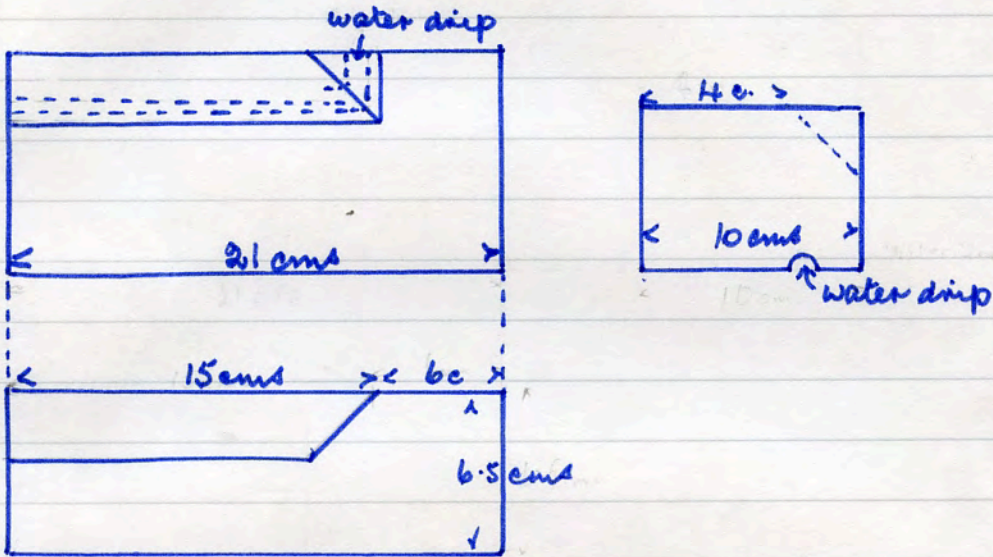

No name 255 IR red from brick shale. T.C finish

4766

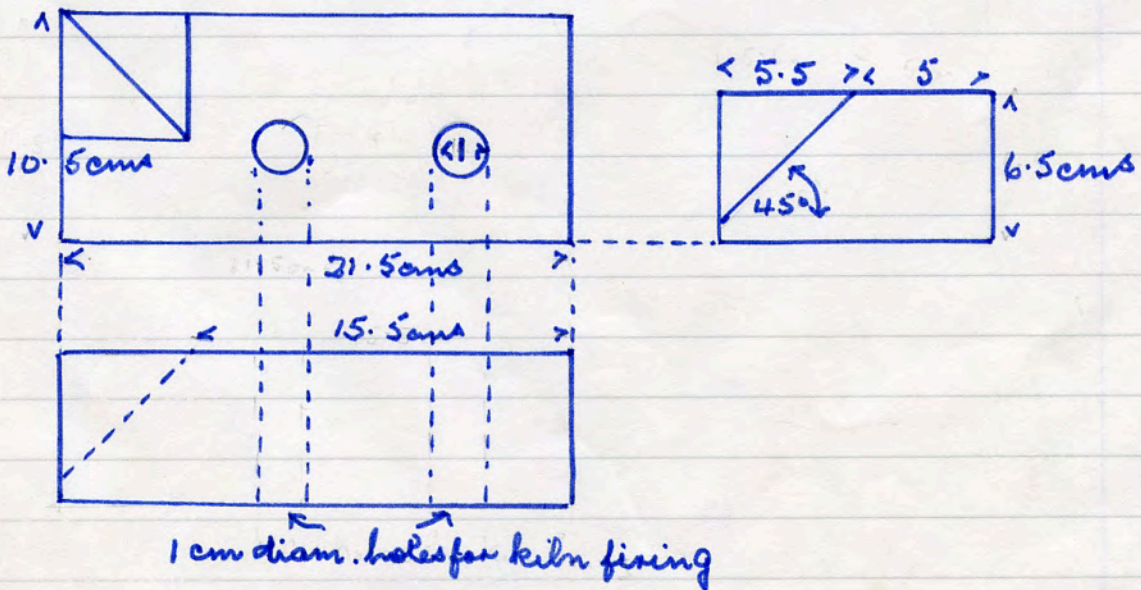

7lbs

All above - Acpton Moss dem. site 26. 7. '90

No name 255 1L red from brick shale T.C finish
7 lbs

4767

4767

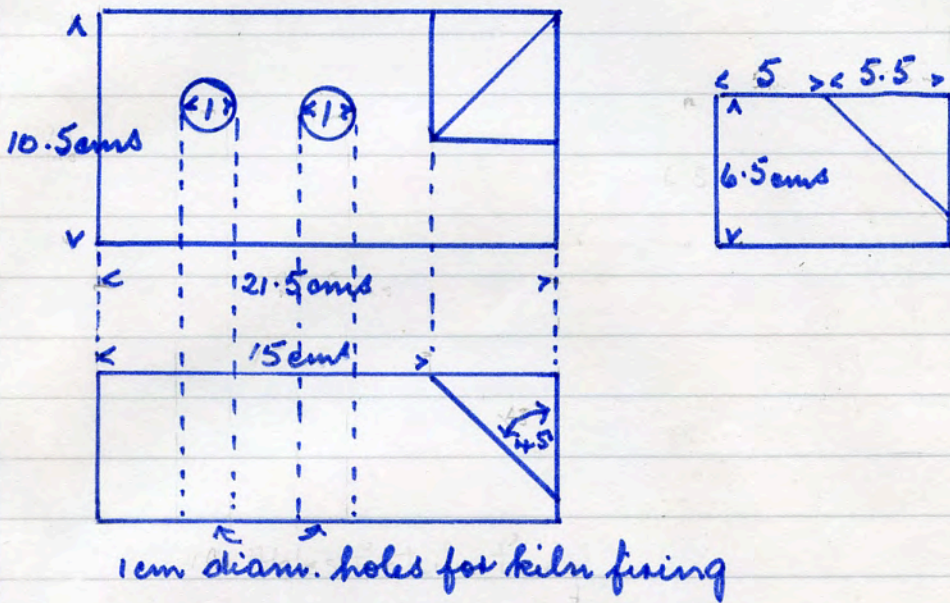

No name 2586 R red T.C. finish 6 lbs

4768

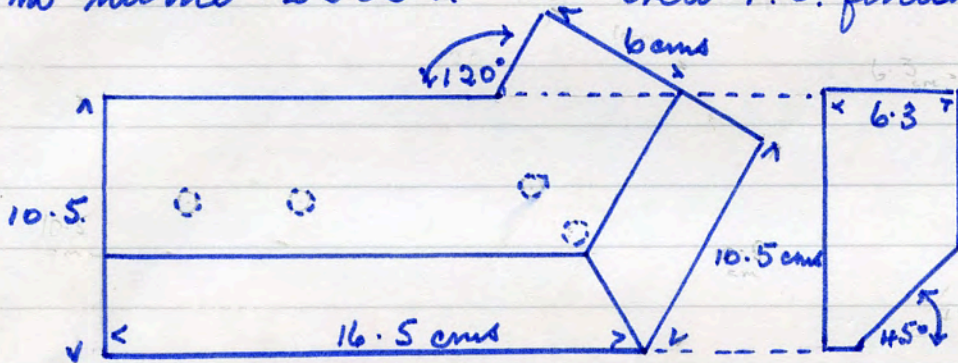

No name 2586 L red T.C. finish 6 lbs

4769

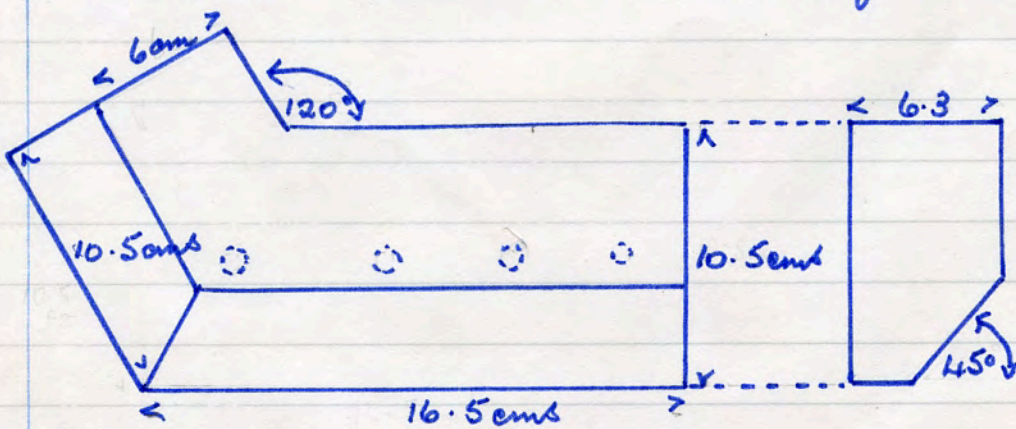

All above - Acpton Mexi dem. site. 26. 7. '90

No name 2566 R red from brick shale
T.C. finish 8 lbs

4770

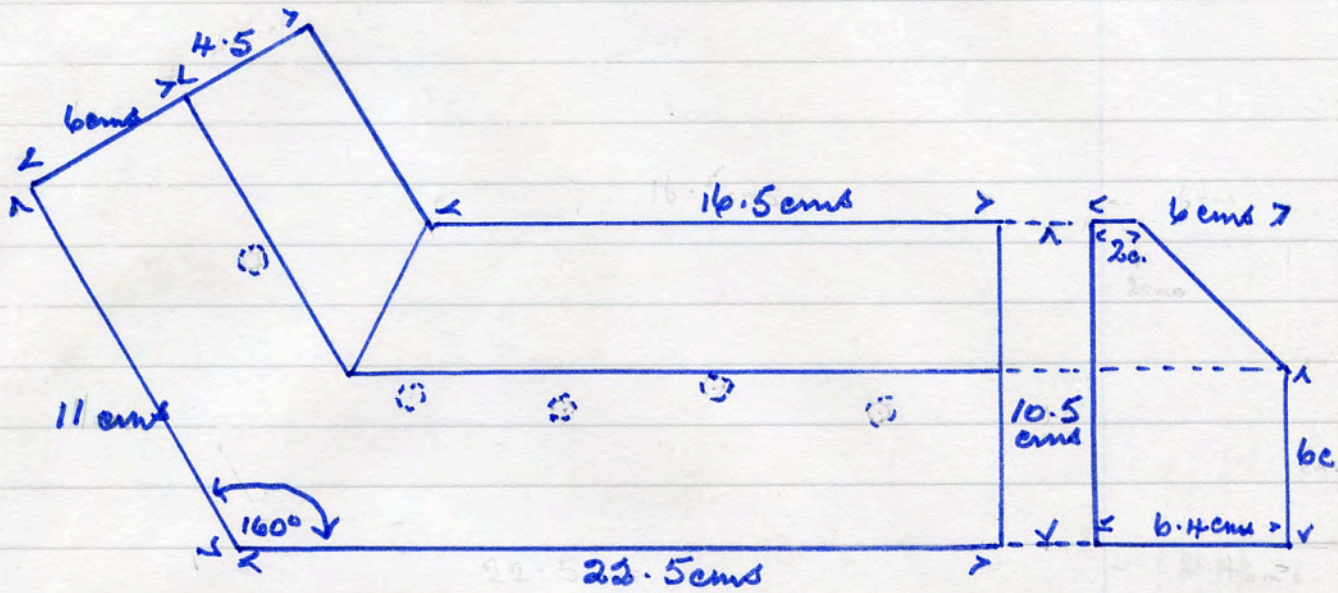

No name. 2566 L red from brick shale
T.C. finish 8 lbs

specification as above.

4771

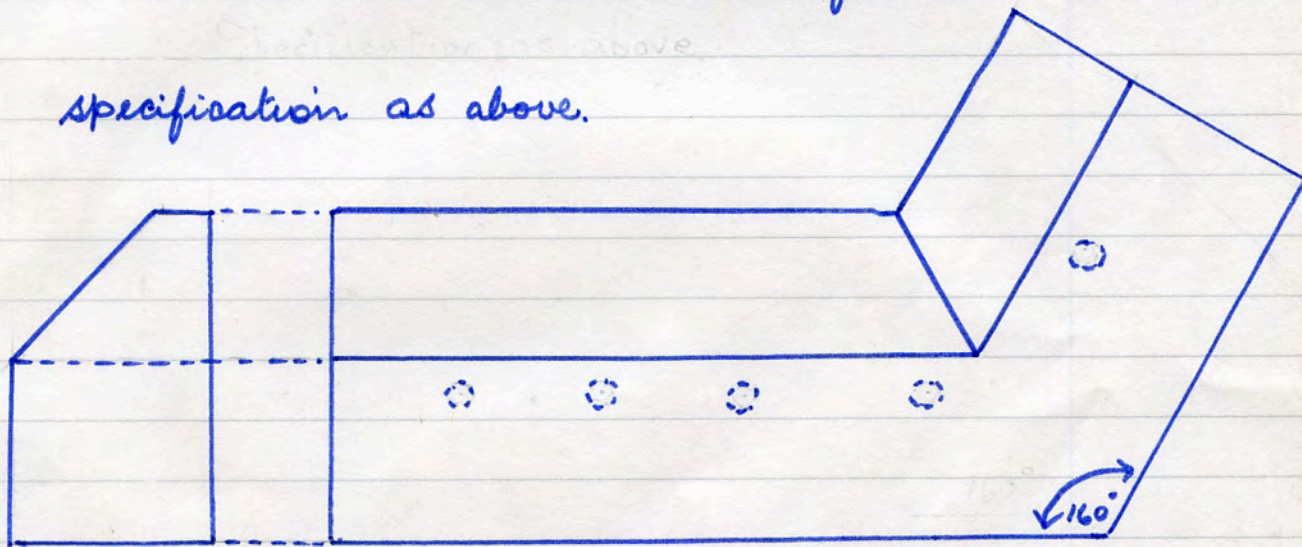

No name 2371 L red from brick shale. T.C. finish
7 lbs

4772

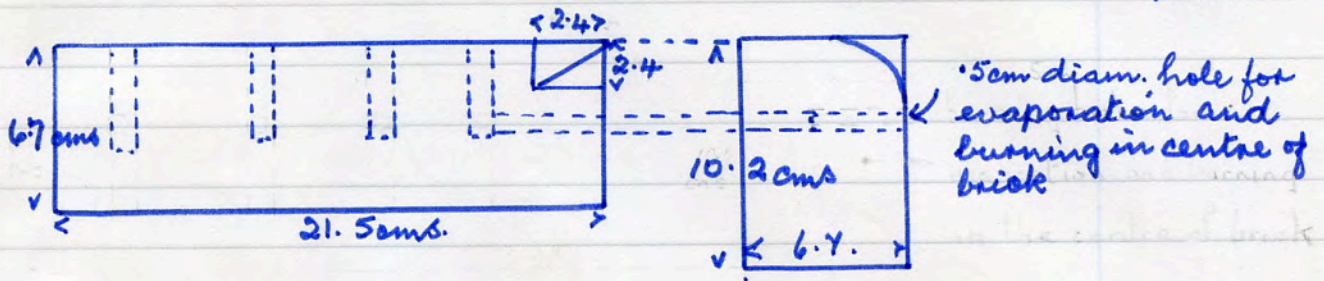

No name 2371 R red from brick shale. T.C. finish
specifications as above. 1.5 cm diam. holes
7 lbs

4773

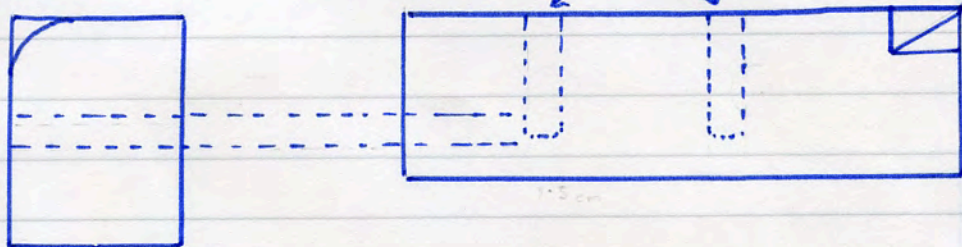

No name FE red from brick shale. T.C. finish
8 1/2 lbs

4774

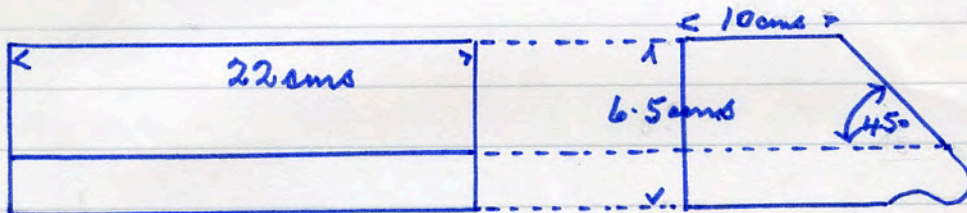

No name 138 TB red wire run 1 face edge 1 face
side

4775

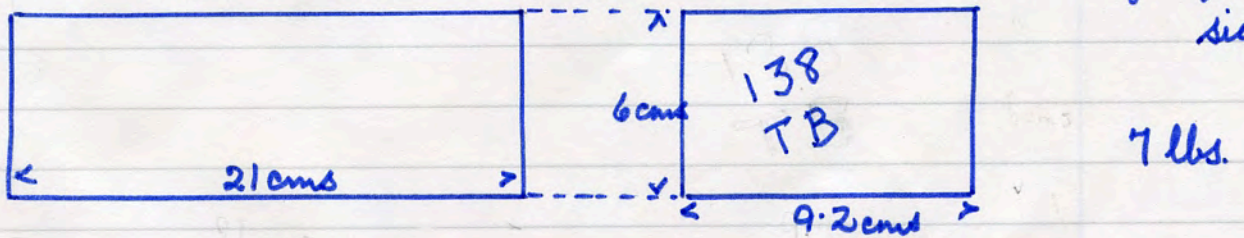

All above - Accpton Mori dem. site - 27. 7. '90

No name 2471 D Bowland Brown splayed return.

16 lbs

4776

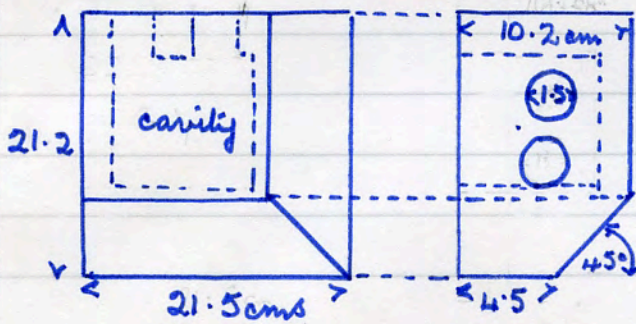

No name. 2471 A red from brick shale prepared

for coating with
T. C. mix.

15 lbs.

4777

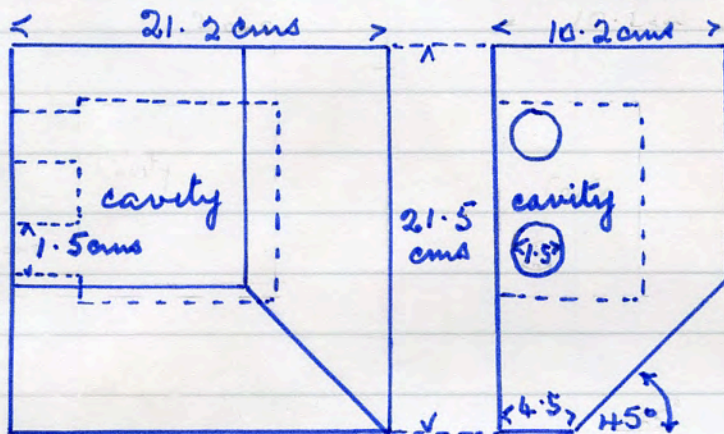

No name 2322 XS red 18 lbs

4778

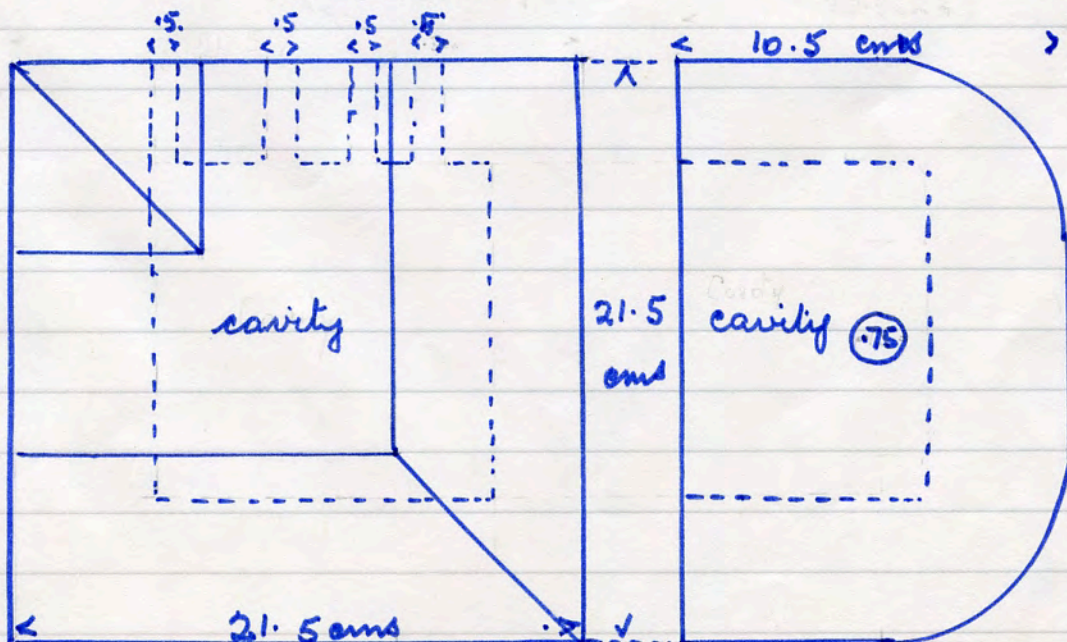

All above - Acclton Moss dem. site

28. 7. '90

No name 2321 D Bowland Brown wire run rustic 7 lbs

4779

4779

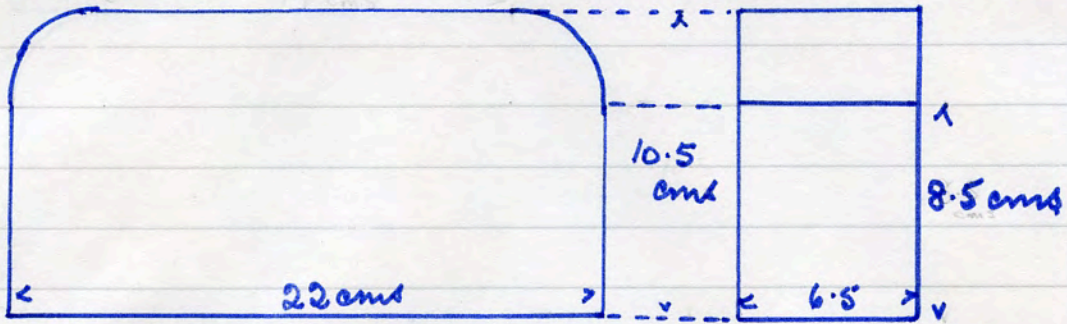

No name 2422 D Bowland Brown wire run 7 lbs

4780

4780

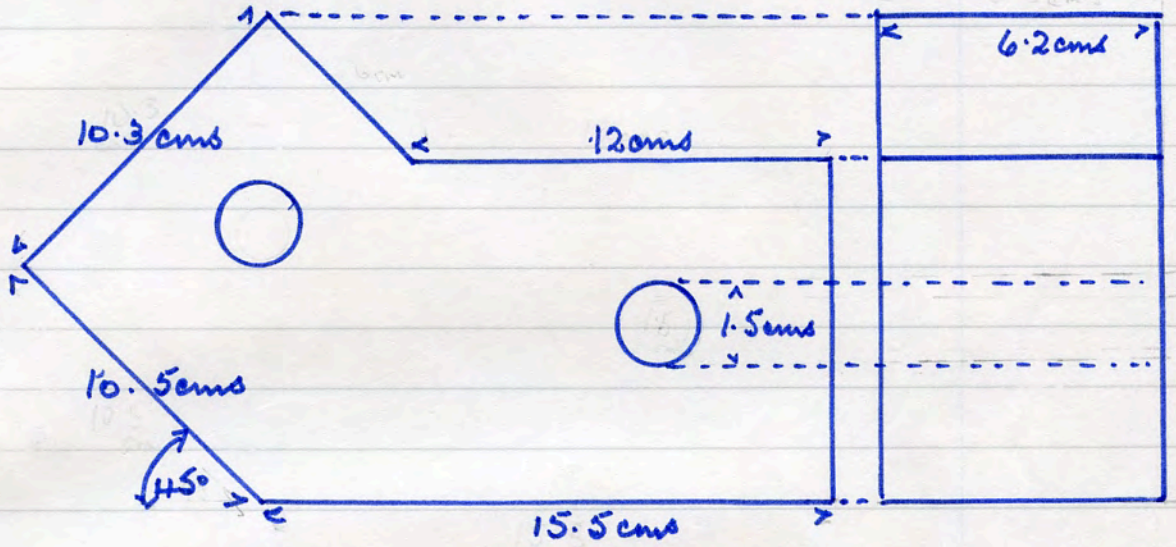

4781

4781

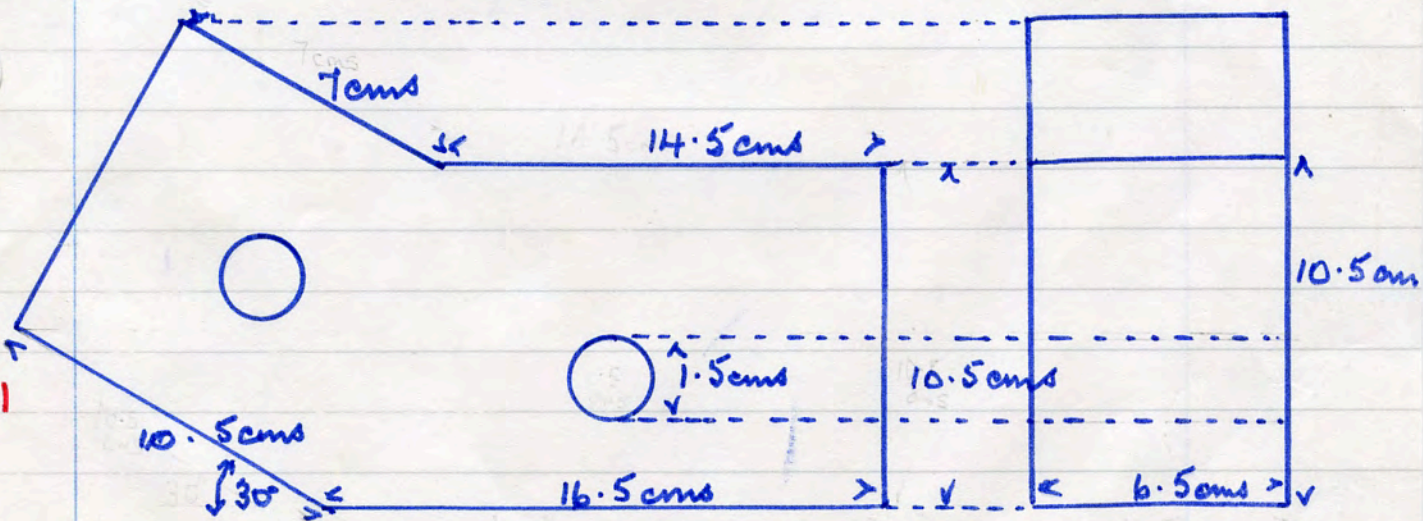

No name 2242 IC Bowland Brown. wire run 8 lbs

No name. 2411A red wire run squint 6 1/2 lbs

4782

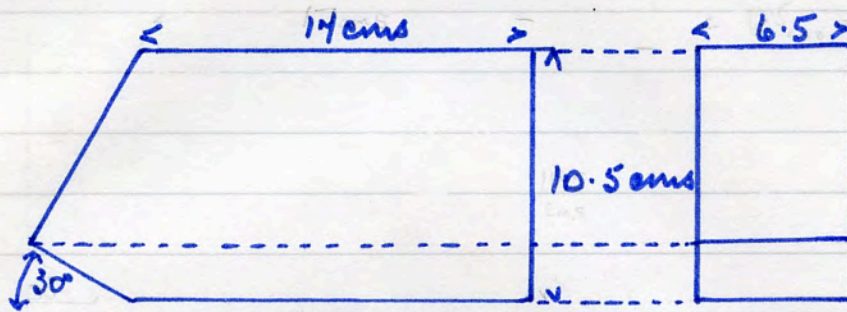

No name 37 RF red. face edge & 2 ends T.C. finish 7 lbs

4783

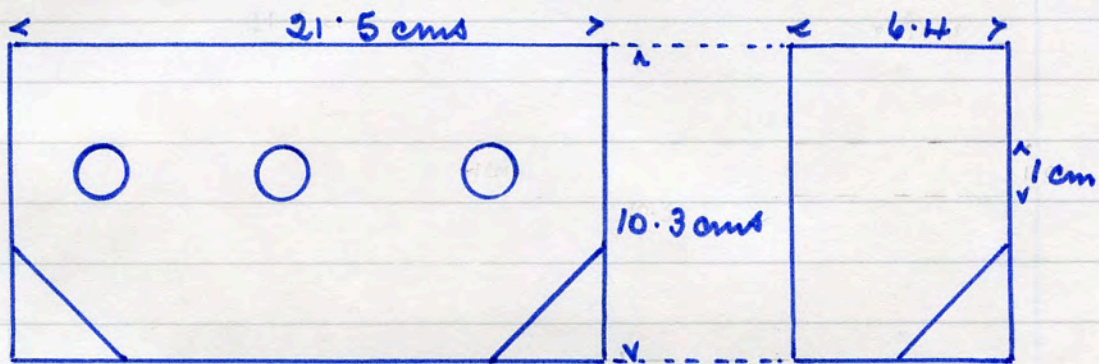

ACCRINGTON NORI stamped obv. red closer brick 8 lbs
2 3/4 in relief rev.

4784

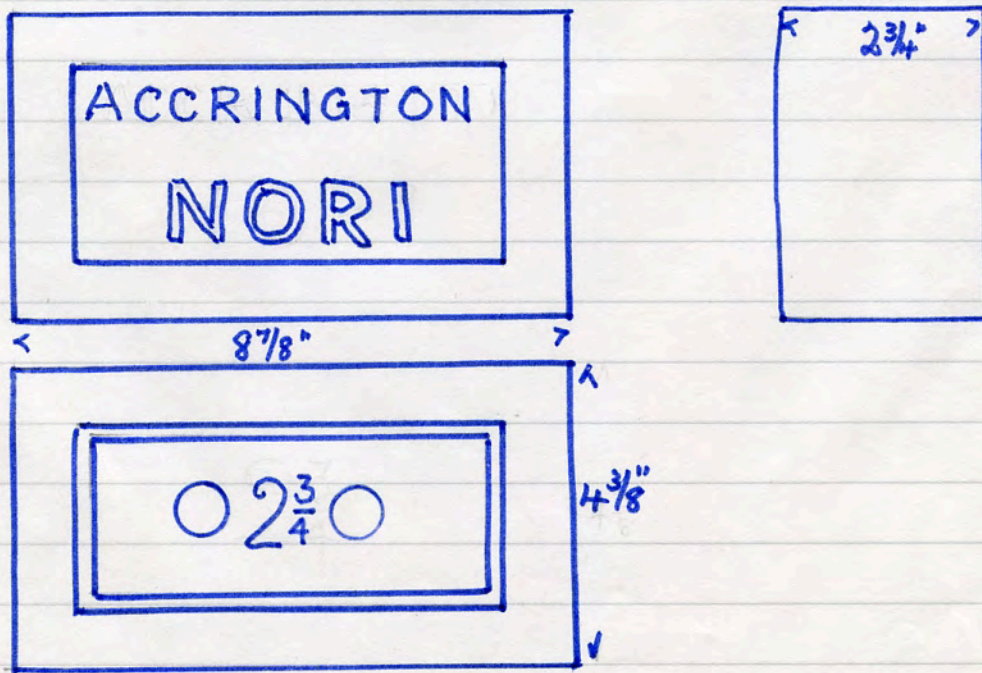

All above - Accrington Nori dem. site 28. 7. '90

4785

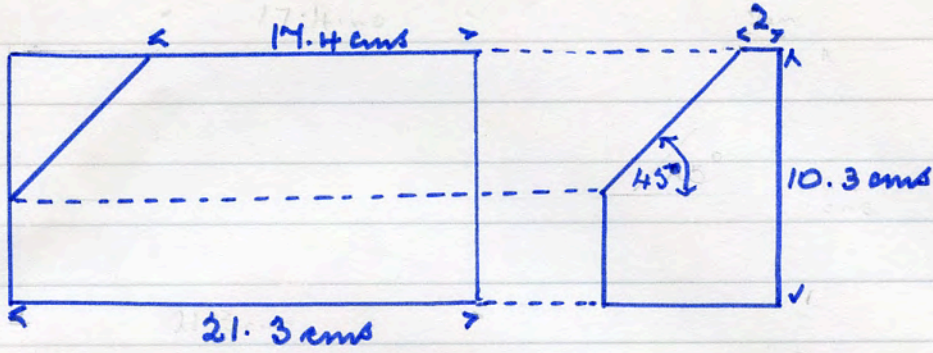

No name 2512 AL red. wire run finish 8 lbs

No name 36 R 21 red. T.C finish dressed 1 face 9 lbs

4786

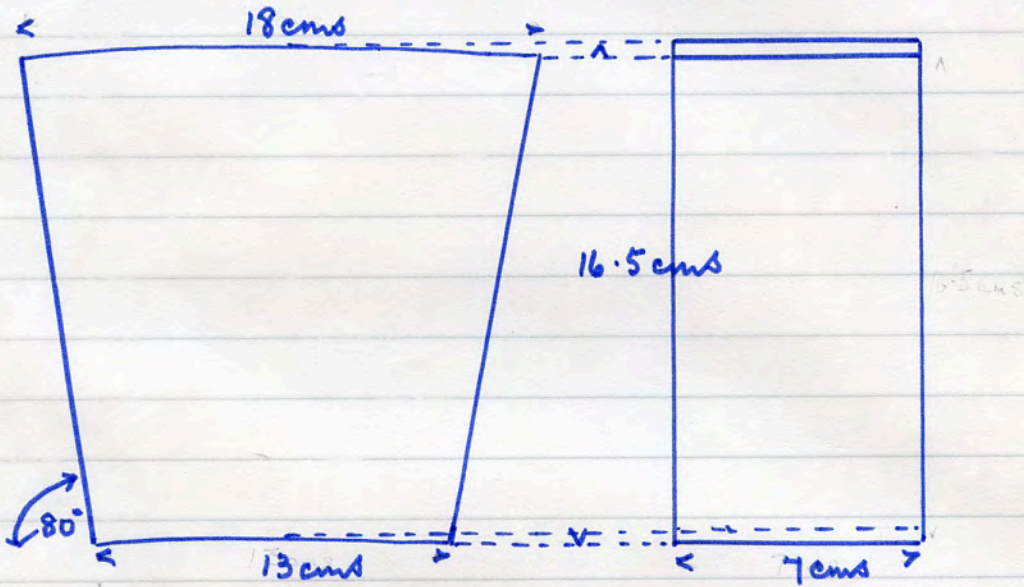

No name BT 91 red dressed face side T.C. finish

15 lbs

4784

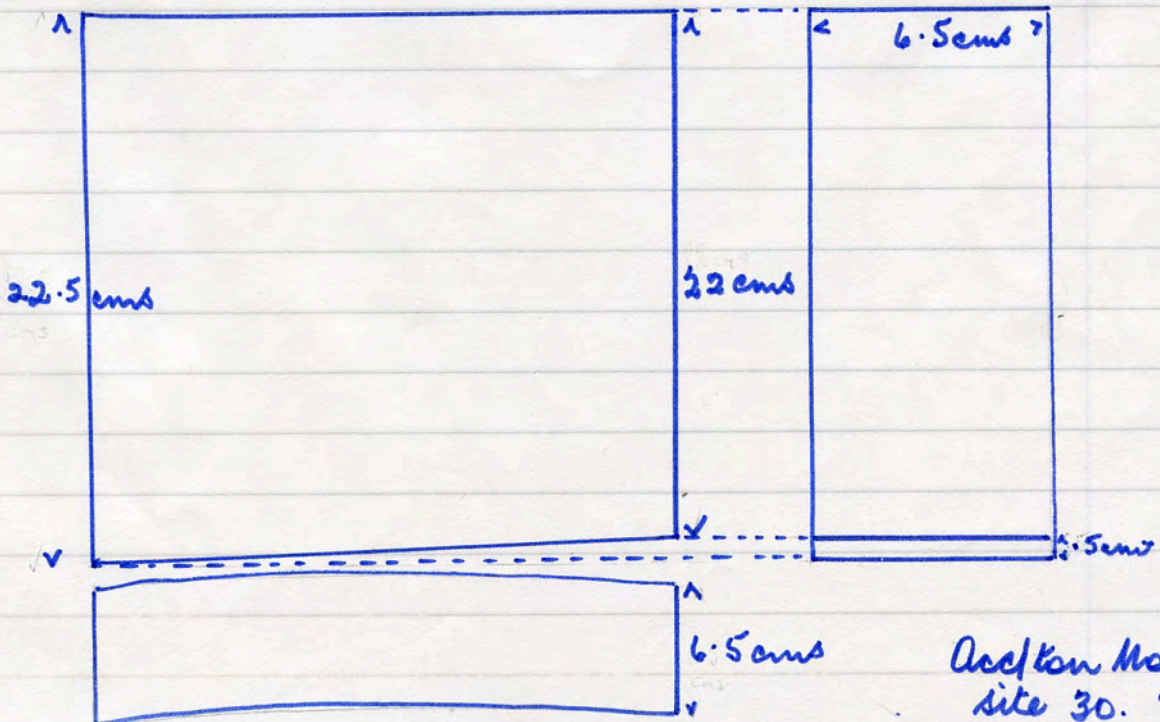

Auction Moni dem.
Site 30. 7. '90

No name 24 22C Bowland Brown dog leg 7 lbs
wire finish 1 face edge

4788

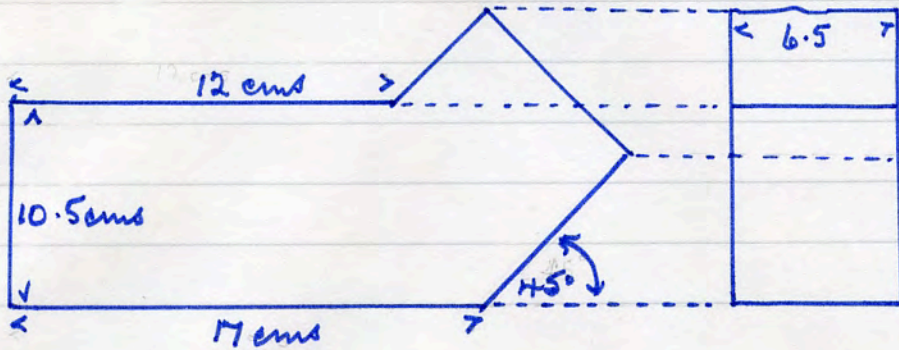

No name 89 N 18 red brick shale. face side & edge
T.C. finish. 3 lbs

4789

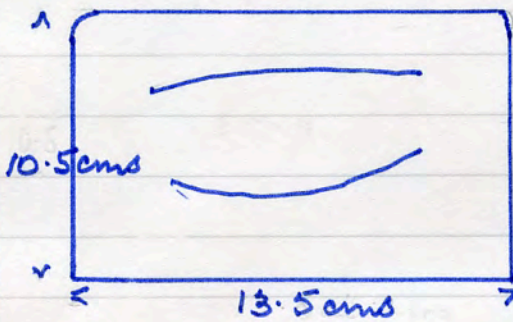

moulder's mark & cuneiform shape
.2 cms camber

No name 175 Z red brick shale. face side & edge T.C. finish
7 lbs

4790

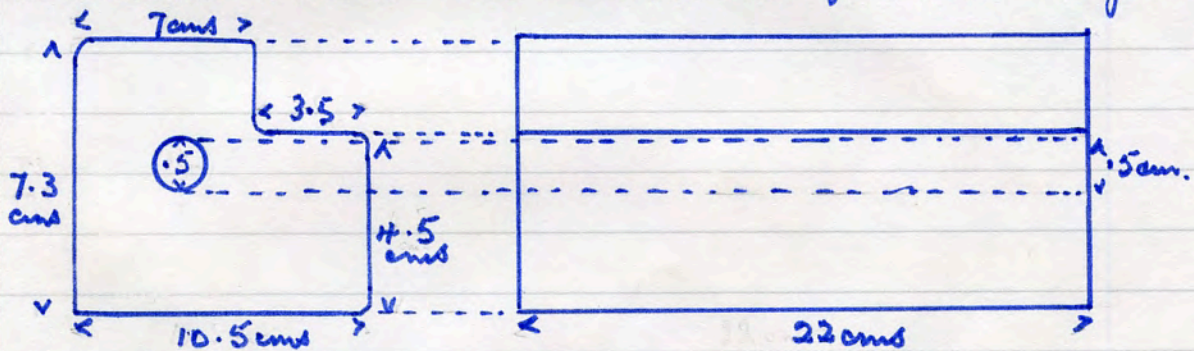

No name 66 4B red brk shale. top & bottom edge T.C. finish
7 1/2 lbs

4791

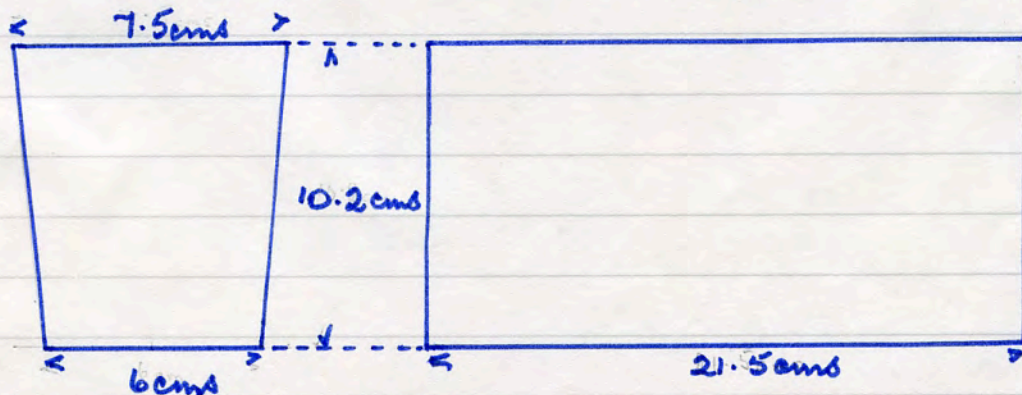

All above - Acpton Mori dem. site 30. 7. '90

4792

No name 24 62 red shale, wire run 7 lbs

4792

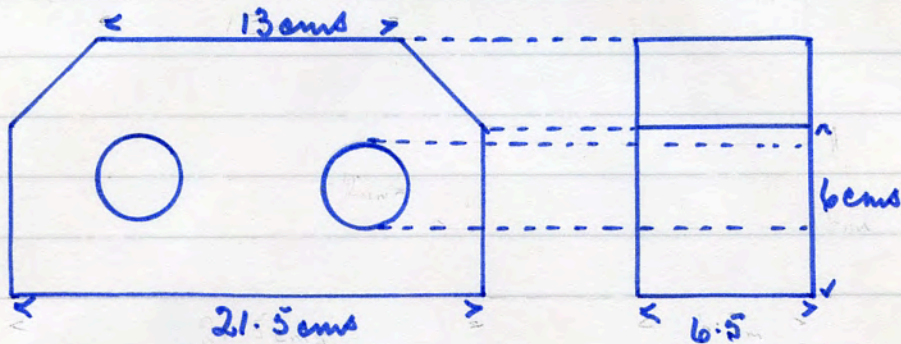

No name WW red closer, wire run 5 lbs

4793

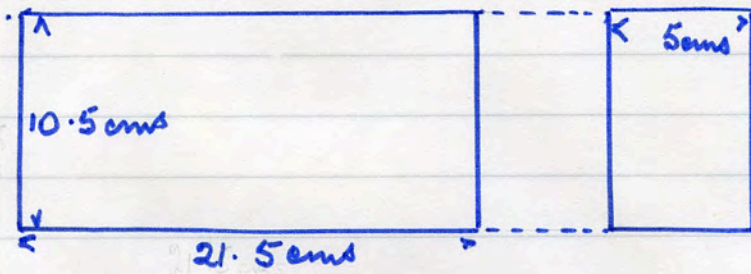

4794

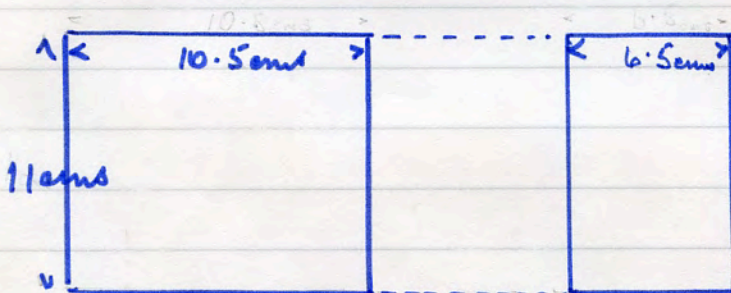

No name 11 5T red, wire run 3 lbs

No name 275 TF red, all faces finished T.C.

4795

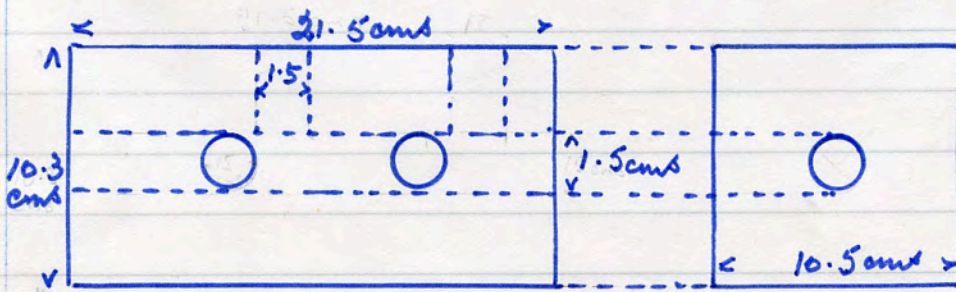

All above - Acceptor Mori dem. site 30. 7. '90

No name D. arch brick. red brick shale. wire run. 8 lbs

4796

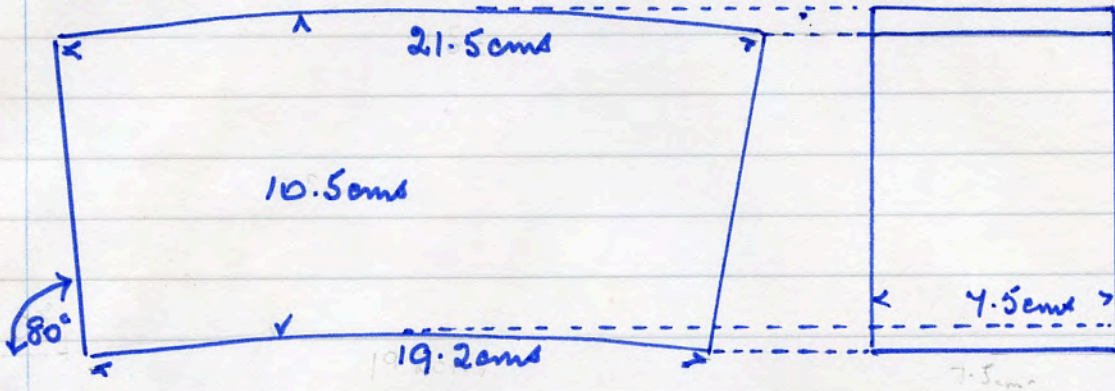

No name 271 50 red wire run gauged

4797

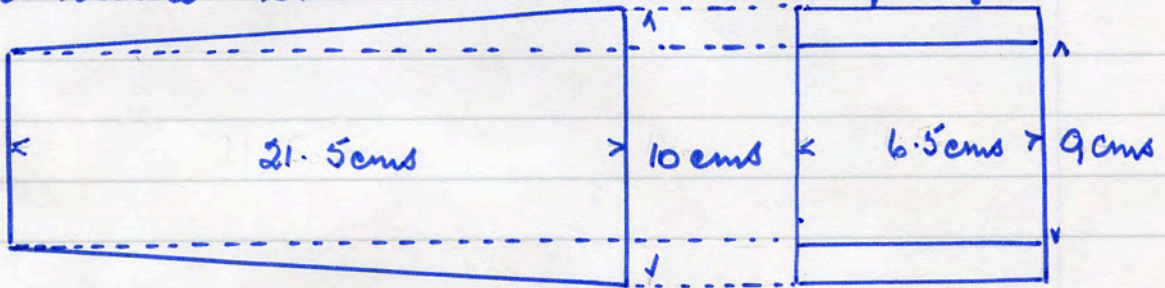

No name 54L 13
red wire run

4798

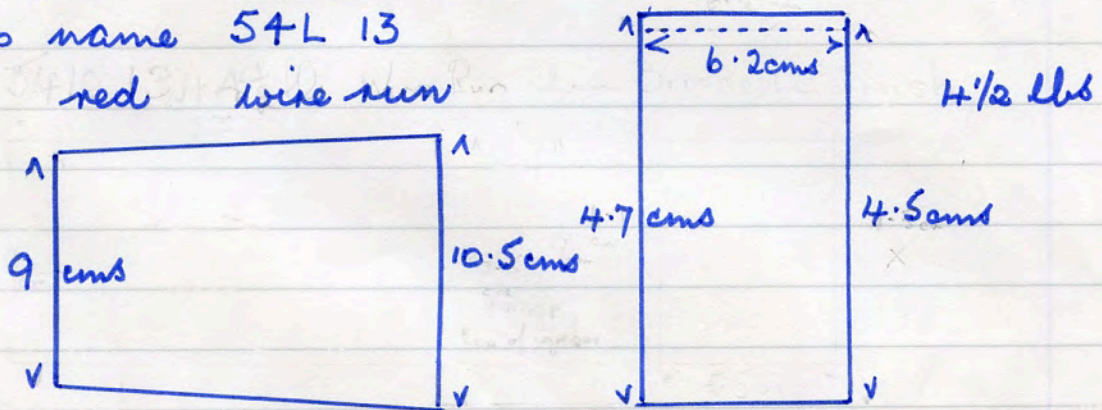

4799

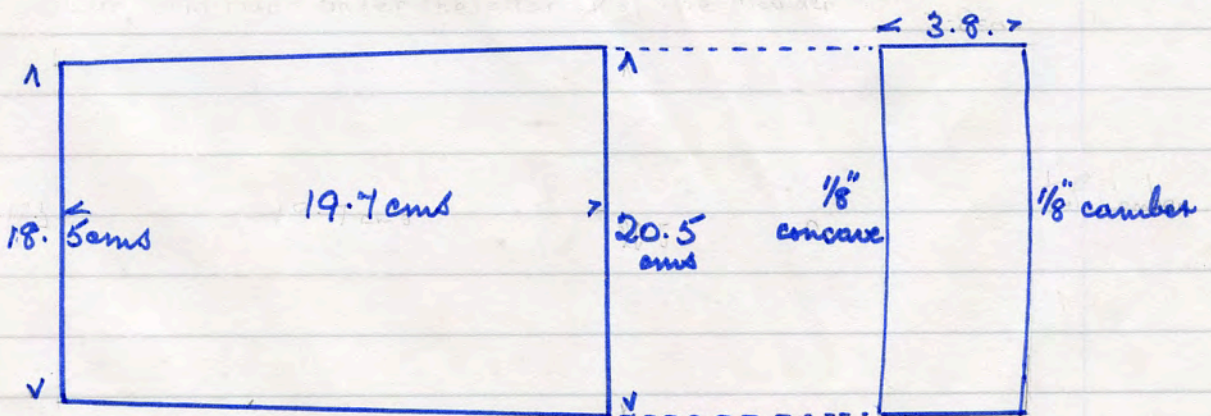

No name. 12 Q 8 plain red cambered tile 7 lbs
not finished in T.C. moulder's mark D under letter Q

All above - Acpton Harri dem. site 30. 7. '90

4800

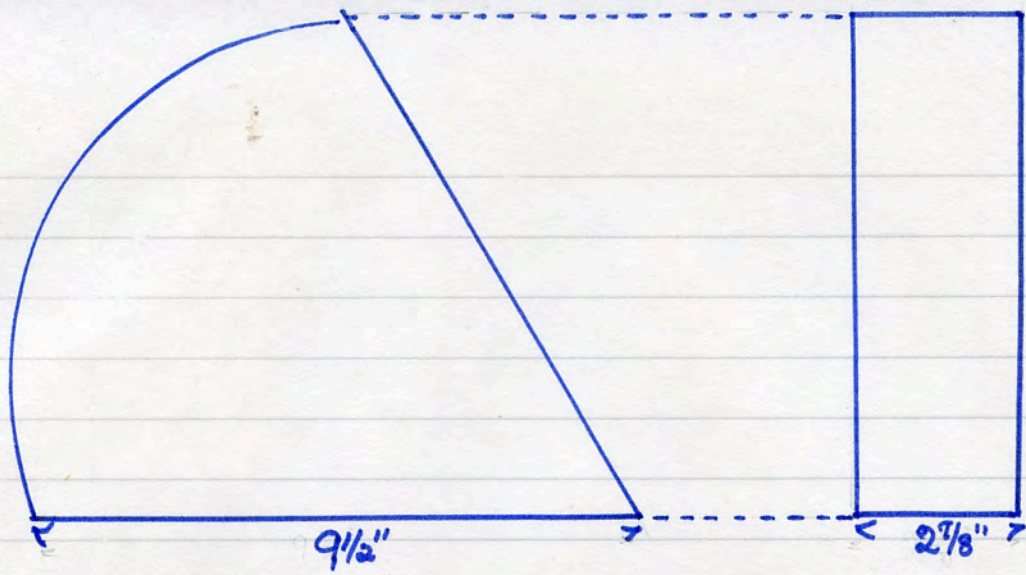

No name 27 G 4 red. unfinished T.C 11 1/2 lbs
 moulder's mark HB

4801

No name 190 D red gauged. T.C finished 1 face
 2 ends

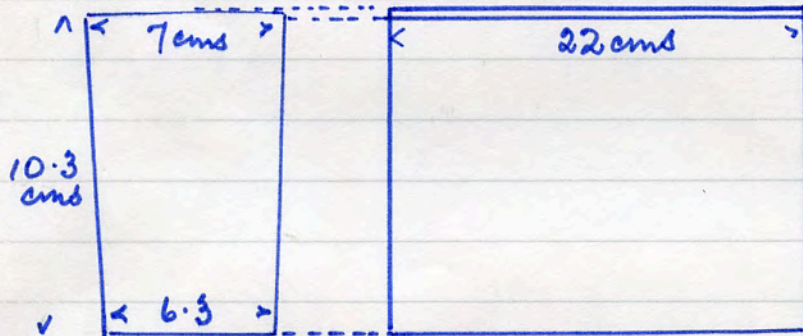

4802

No name 45 red squint

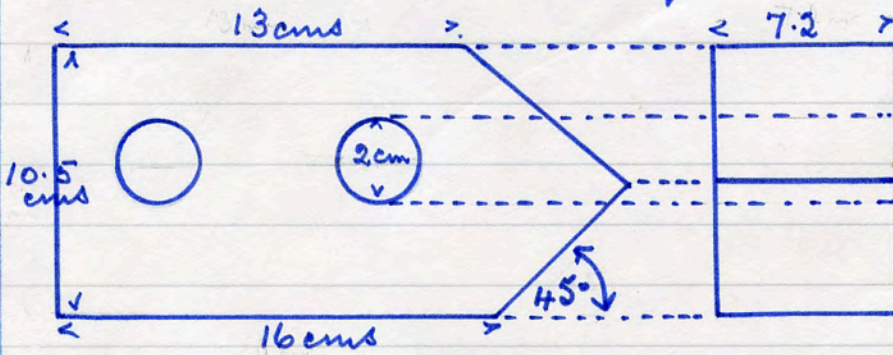

H803

No name AS red wire run 6 lbs

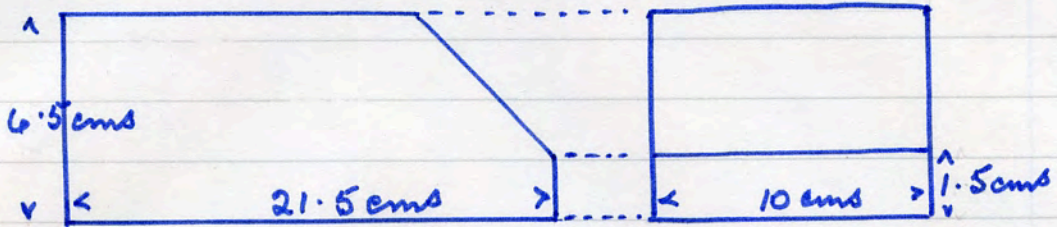

H804

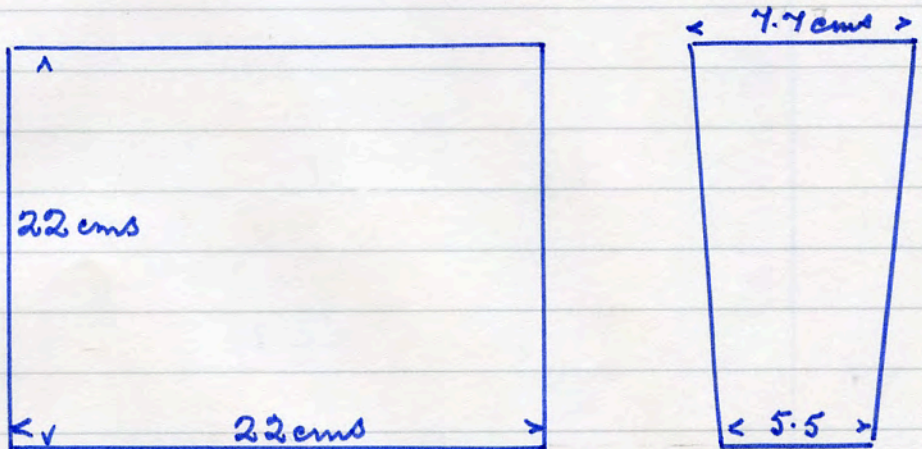

No name 56 H 58 red. all edges dressed T.C. 14 lbs

H805

No name 130 D red. 1 face side + face end T.C. dressed

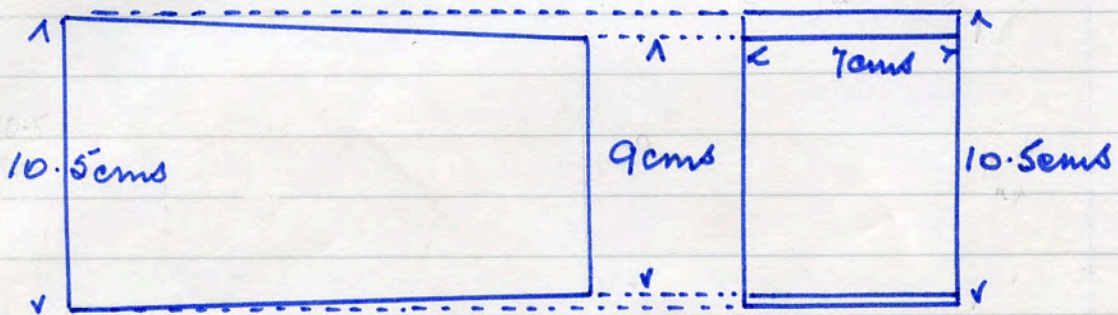

H806

No name 982 VZ red. wire run all round 5 lbs

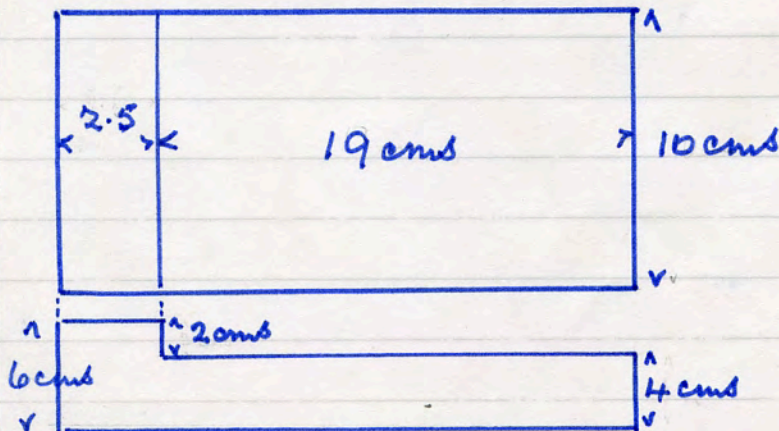

No name 78 UR Bowland Brown. very coarse cut on all face edges. 7 lbs

4807

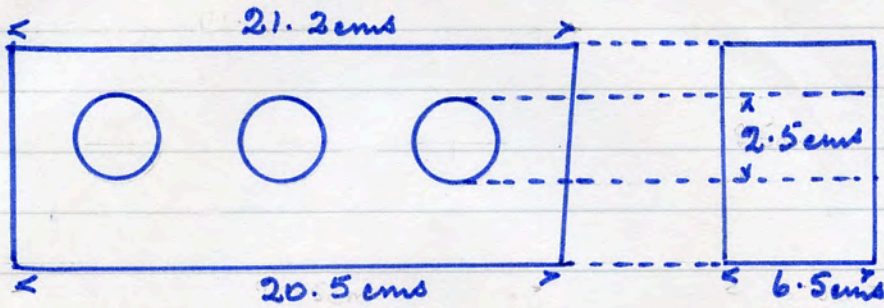

No name 115 T red wire cut 4 lbs

4808

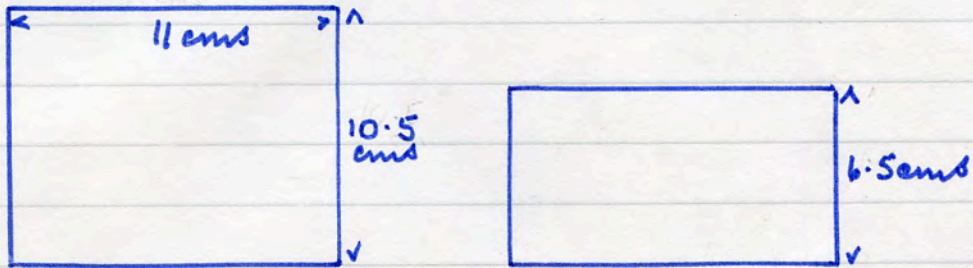

No name 169 T9 red blk shale. wire run 14 lbs

4809

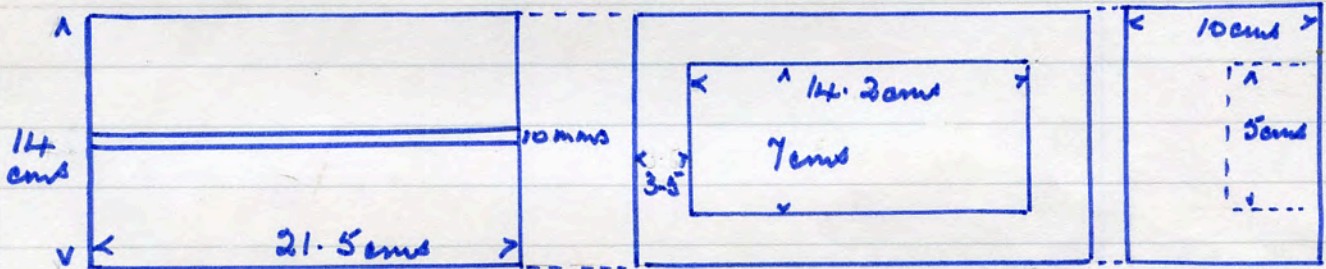

4810

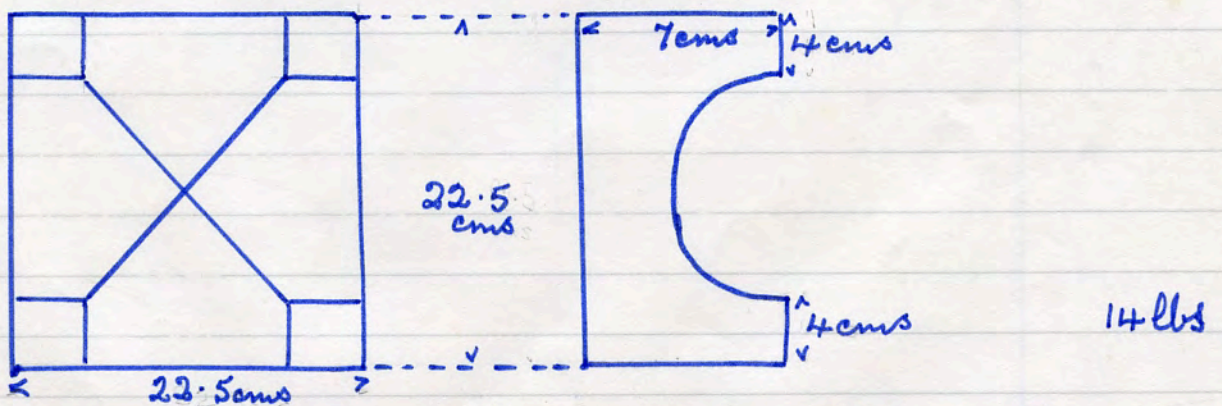

No name 47 W3 red. 4 way liquid crossing all interior area T.C.

All above - Acceptor Moni dem. site 30. 7. '90

No name 91 F 91 red T.C. 4 lbs

4811

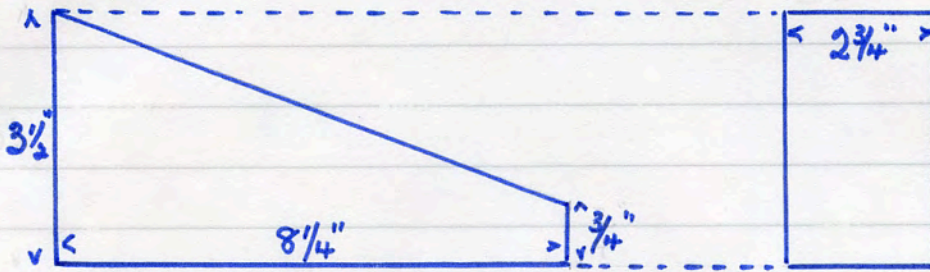

91 F 91 Red TC wt 4 lbs

No name 12
red T.C. 1 1/2 lbs

4812

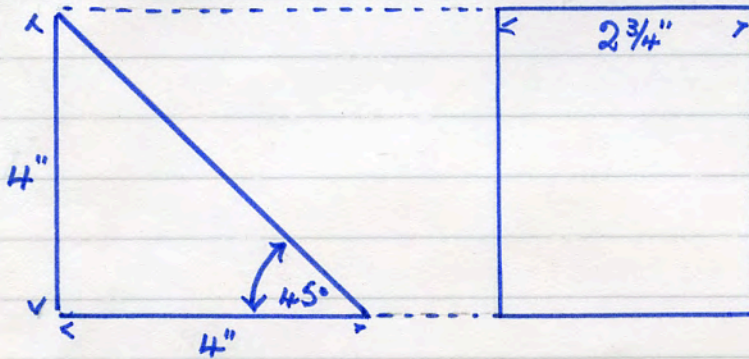

No name 351 TBL red. chamfered return. all surfaces dressed.

4813

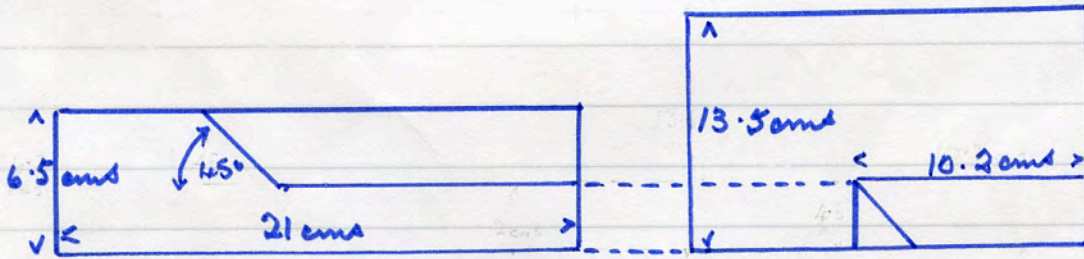

8 lbs

No name FE 4 red T.C. 2 face sides

4814

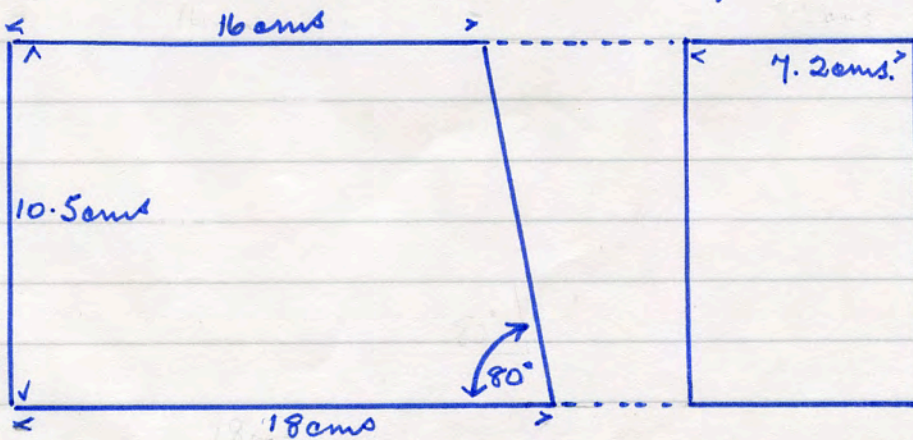

7 lbs

All above - Acclton Mori dem. site - 31. 7. 90

No name 84 Q 23 red T.C. internal faces only dressed.

4815

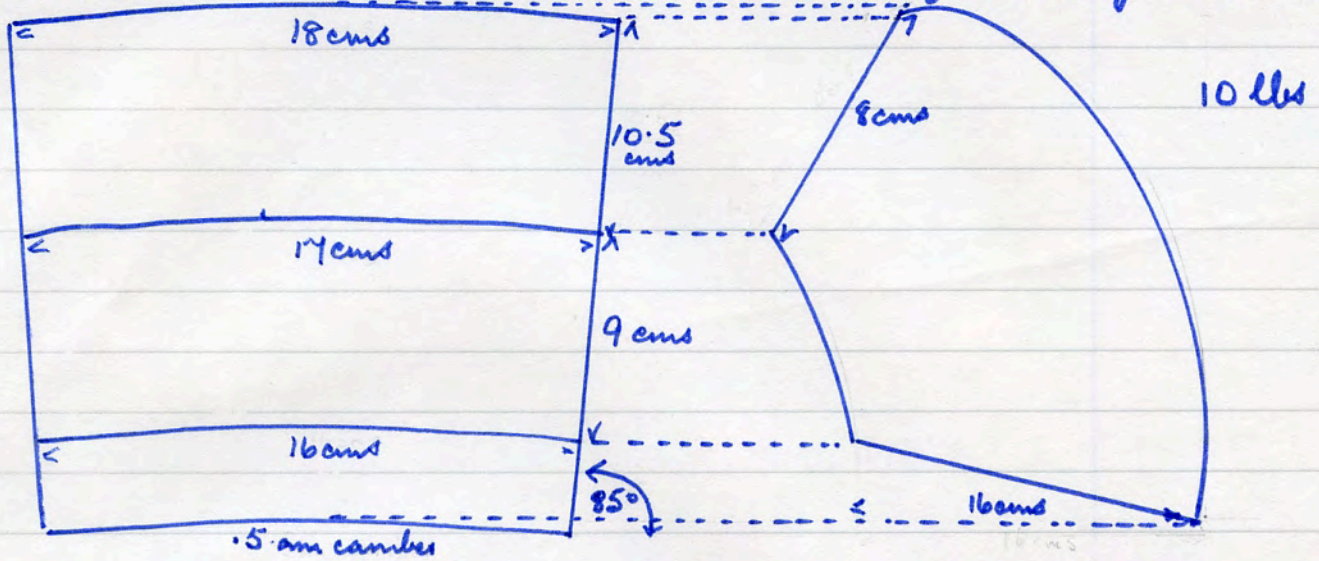

No name CTF red wire cut all over. 8 lbs

4816

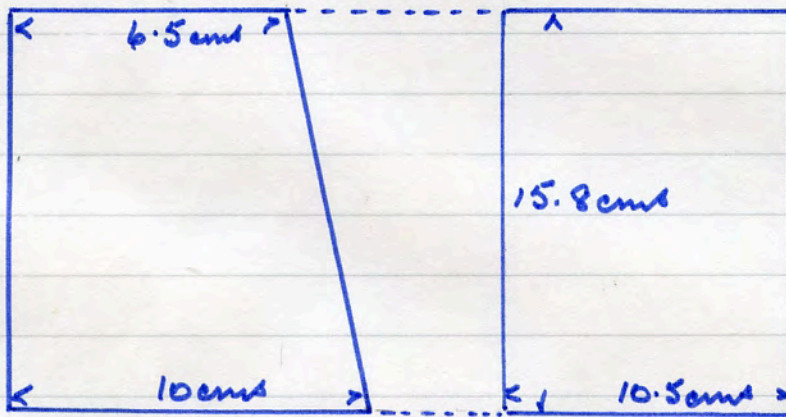

No name 193 VA red T.C. trough 8 5/8" long

4817

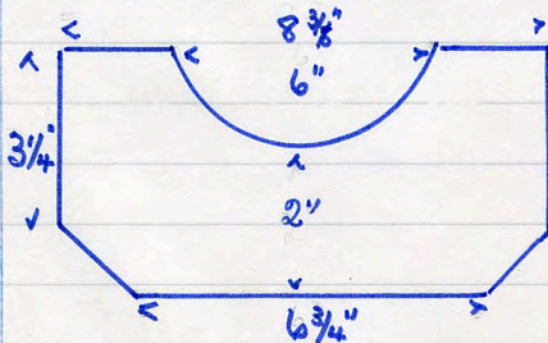

moulder's mark II 17 lbs.

All above - Acpton Harri dem. site 31. 7. '90

4818

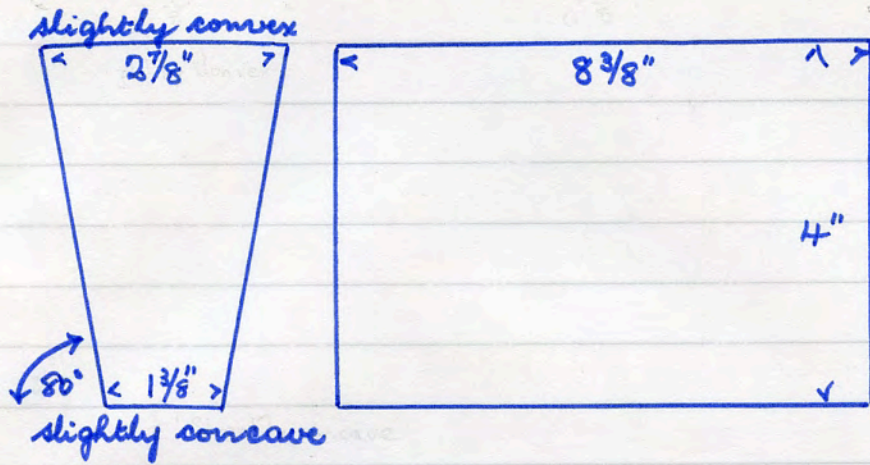

7 lbs

No name 66 UR red T.C. face edges only dressed.

No name 40 R1

1 face side dressed T.C.

9 lbs

4819

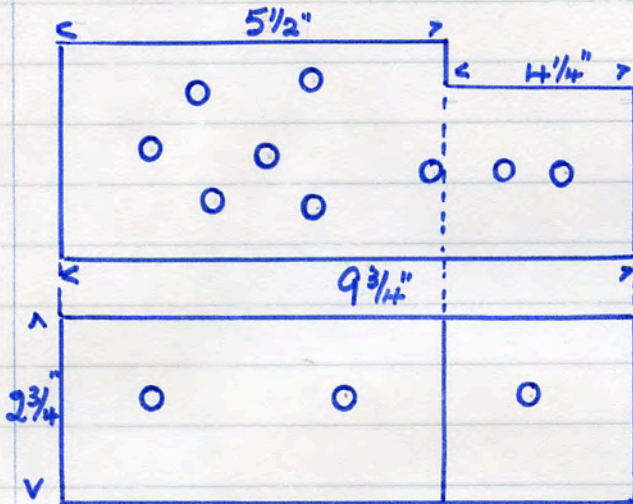

slightly concave.

No name FDD 12 red. 2 sides + the edge dressed T.C.

7 lbs

4820

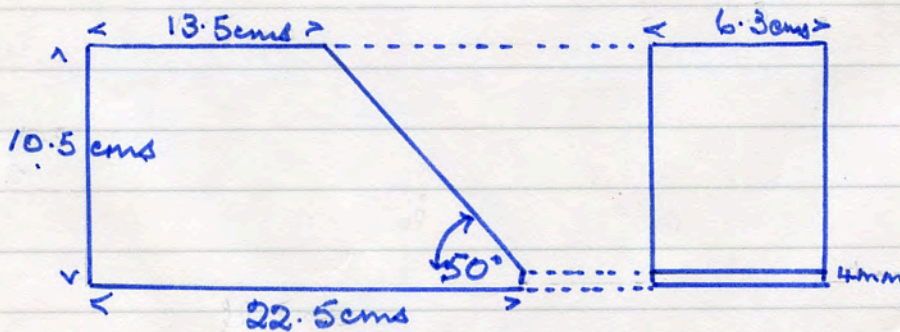

All above - Acpton Mori dem. site. 31. 7. '90

4821

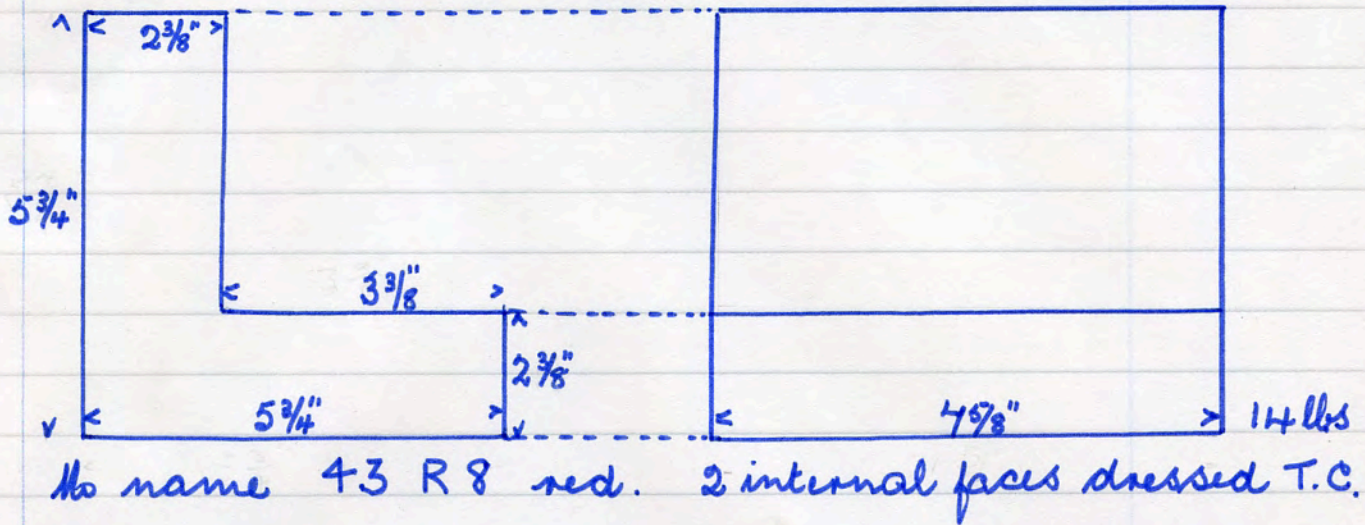

No name 43 R 8 red. 2 internal faces dressed T.C.

No name 891U red. square wall cap. 3 face edges & top T.C finish

4822

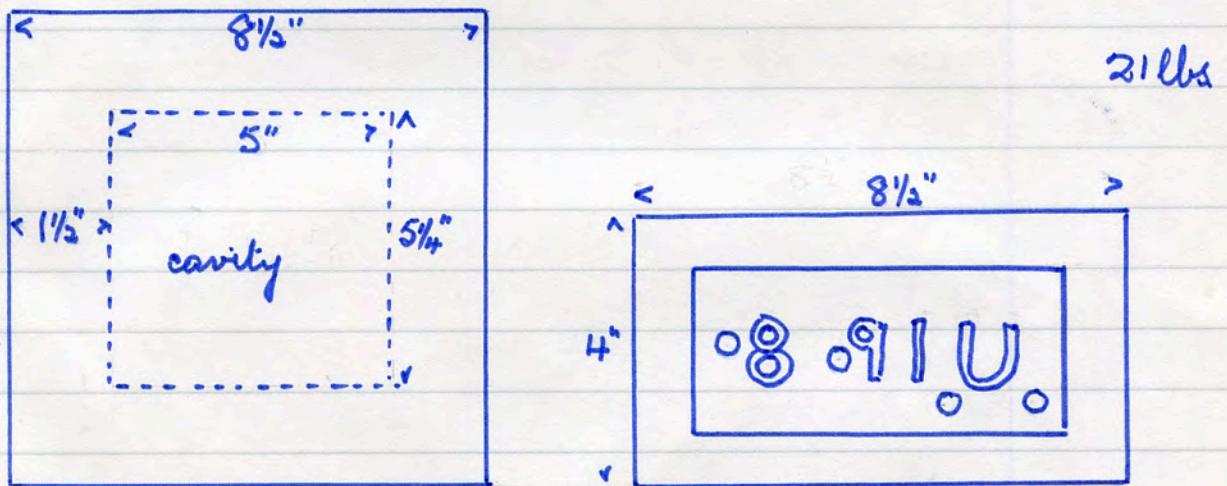

No name 772 U. red. base only without T.C. finish 7 lbs

4823

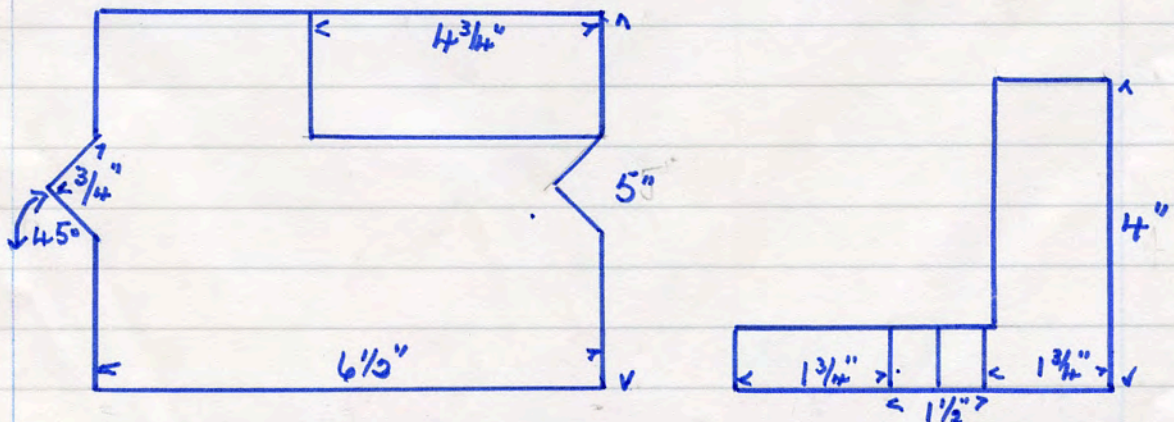

All above - Aspton Mai dem. site 31. 7. '90

No name 131 T 4R red T.C finish 1 face end

with kerf end
8 lbs

4824

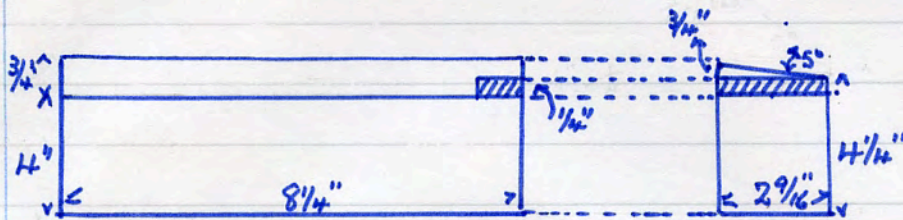

No name 131 T 4L red T.C finish. left hand to

4824 above. 8 lbs.

4825

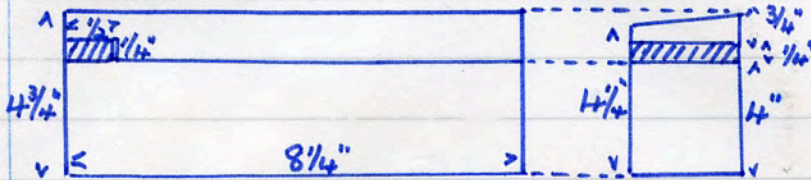

No name 17 P 11 red. wise run. 6 lbs

4826

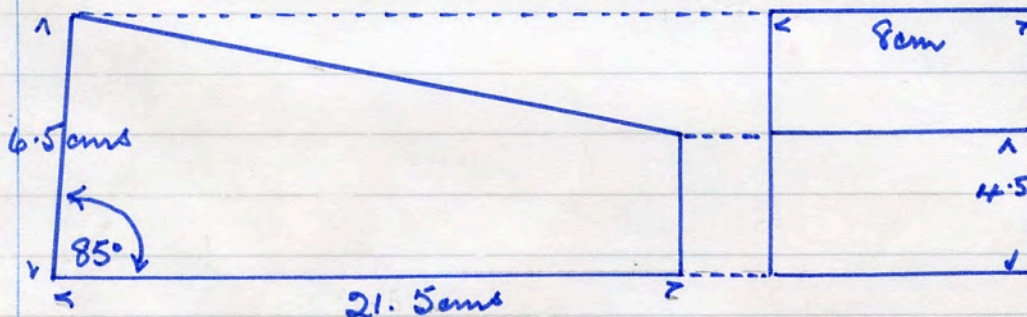

No name UF, Bowland Brown. wise run.

6 1/2 lbs

4827

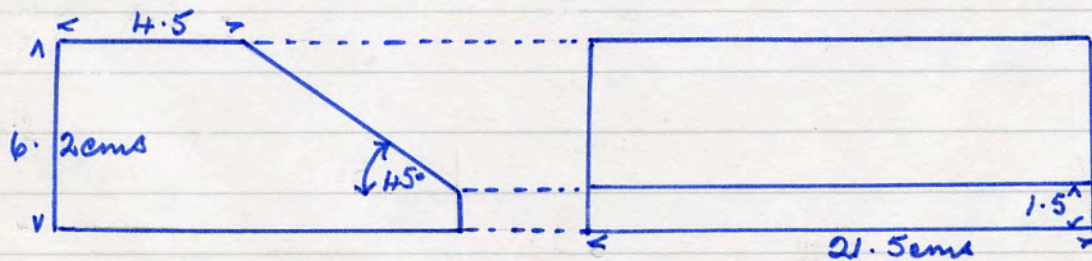

All above - Acpton Mexi dem. side 31. 7. '90

4828

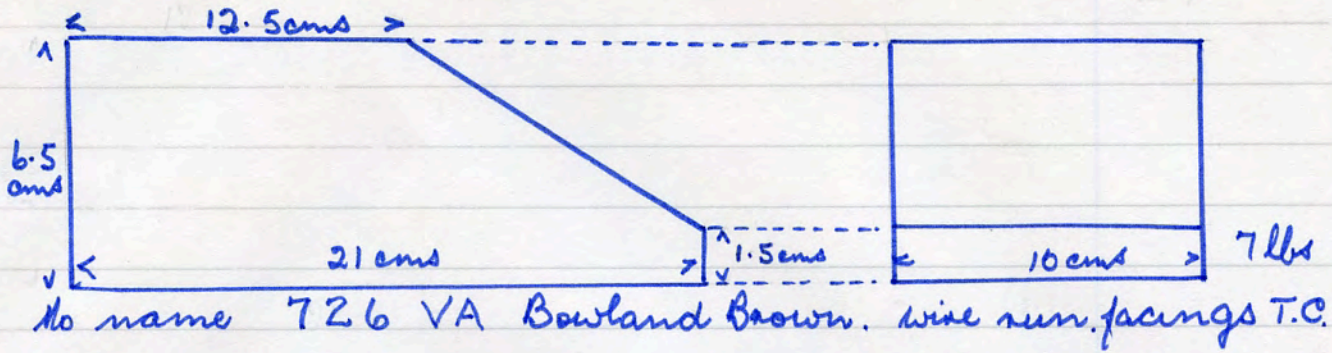

4829

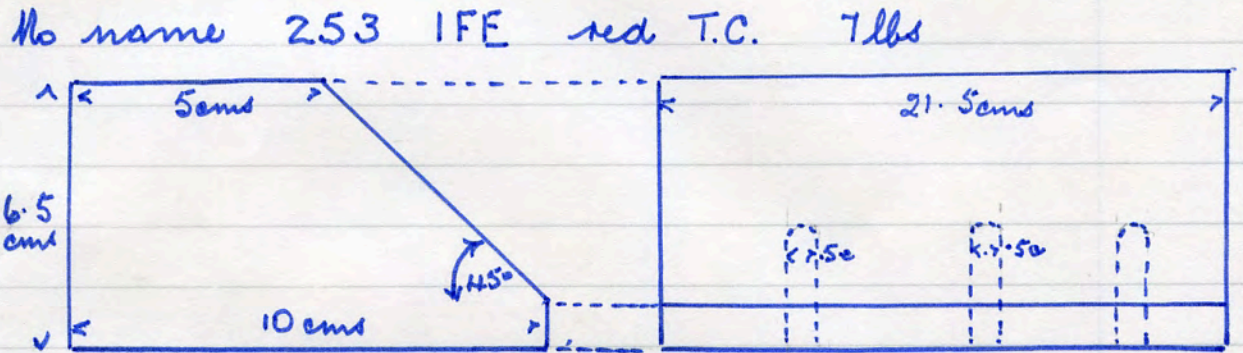

4830

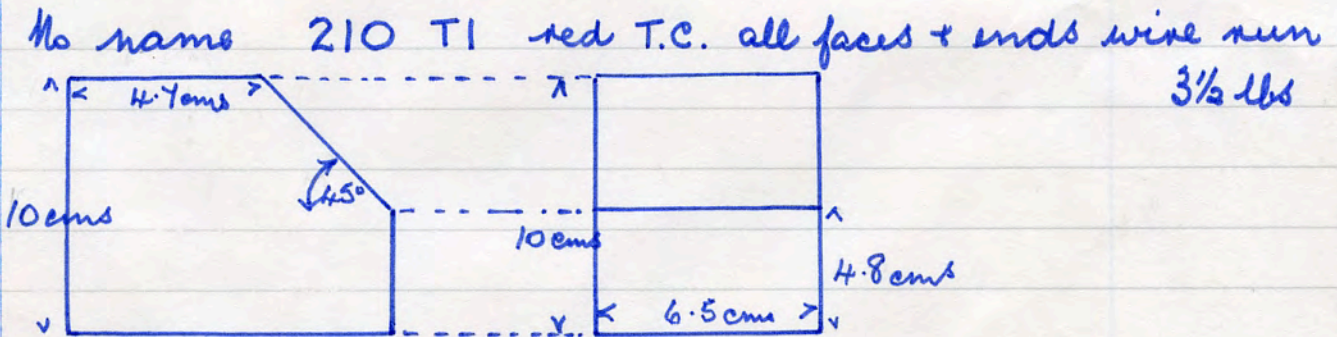

4831

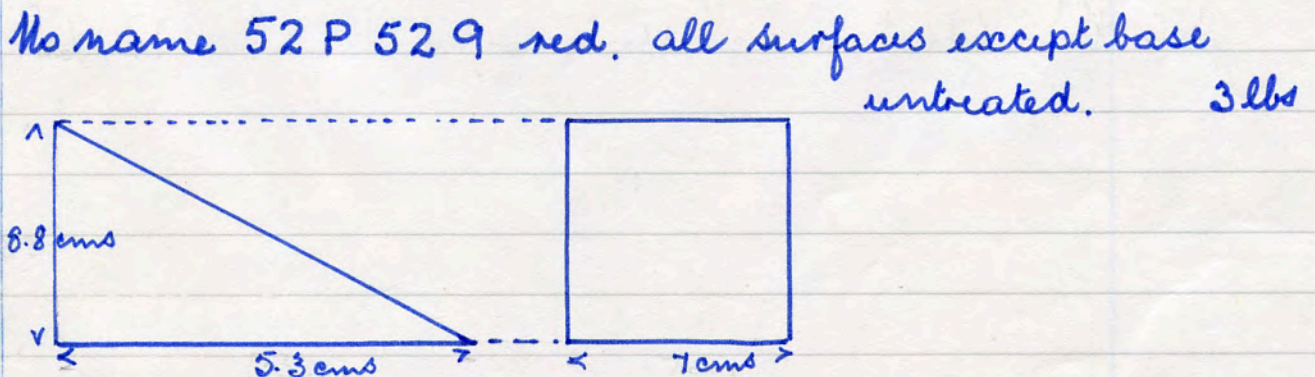

All above - Accpton Mari dem. site 1. 8. '90

No name FD 16. red. were run 1 face side & end treated. 3 1/2 lbs

H832

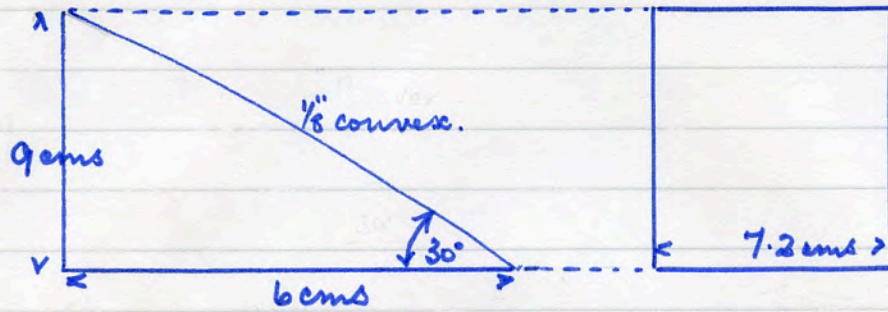

No name KFI red. were run. facial pitch dressed T.C

H833

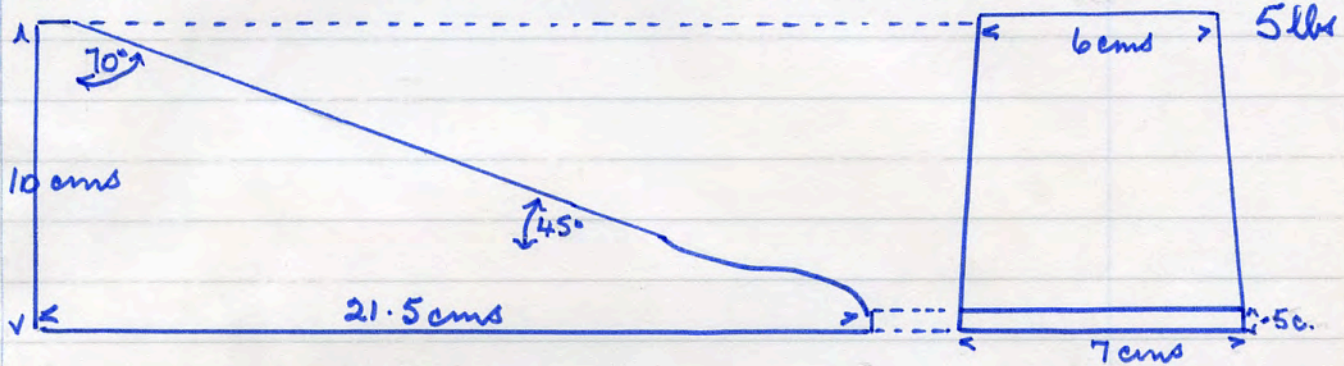

No name 95 IUC red T.C. external faces. internal edges rustic. 7 lbs

H834

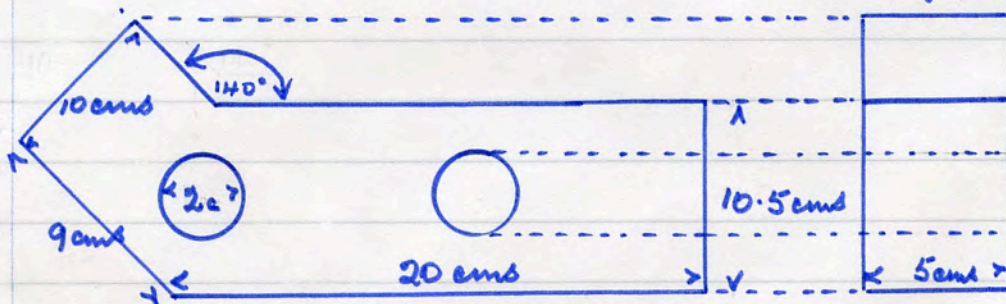

No name 95 IUD red T.C. external faces, internal edges rustic finish 5 lbs

H835

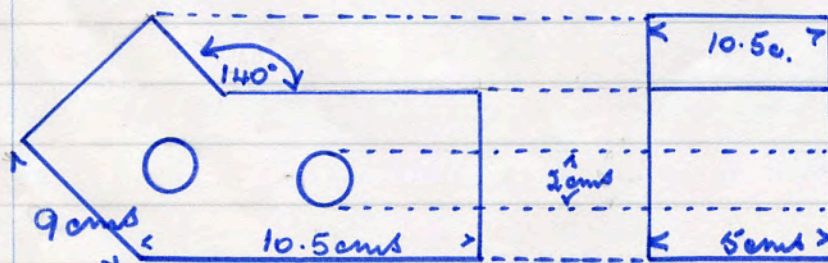

All above - Acpton Mori dem. site. 1. 8. '90

No name 868 VE wire run 1 face end red T.C.

4836

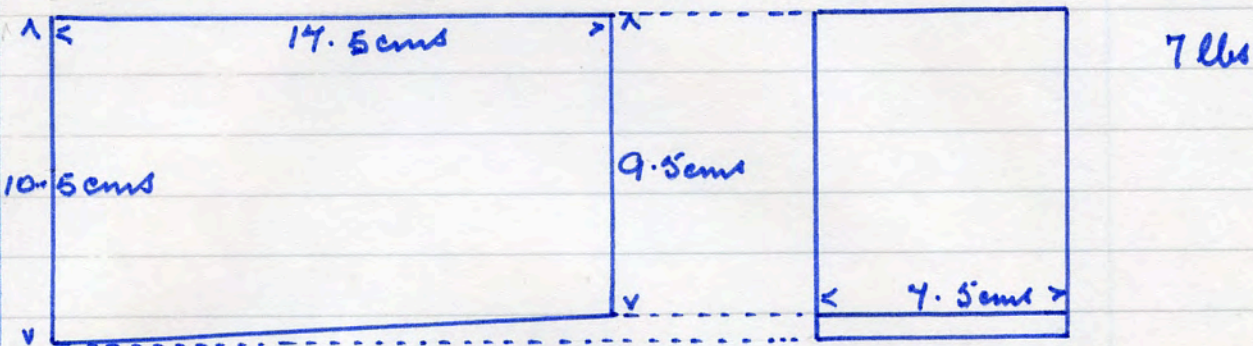

No name 99 OV red. wire run. 2 end 2 face sides T.C.

4837

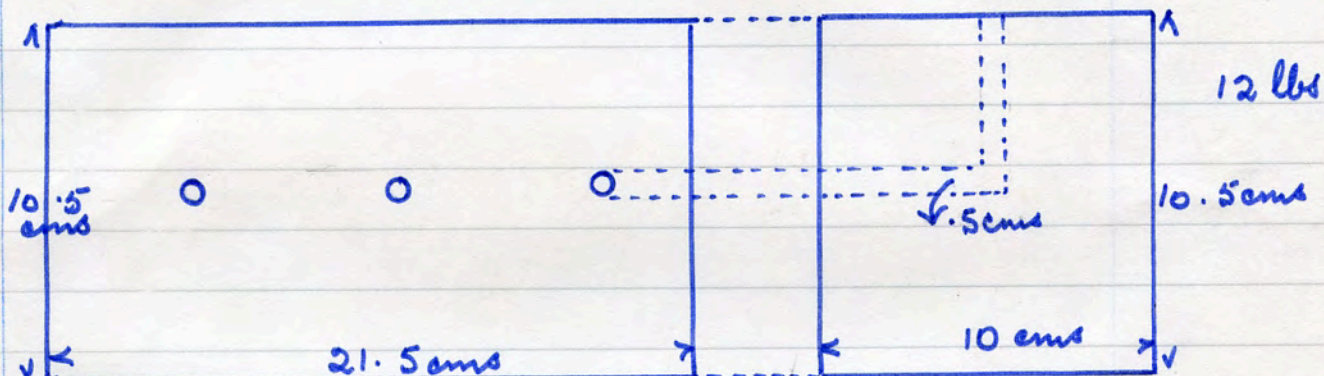

No name 2341 red. 3 face edges T.C.

4838

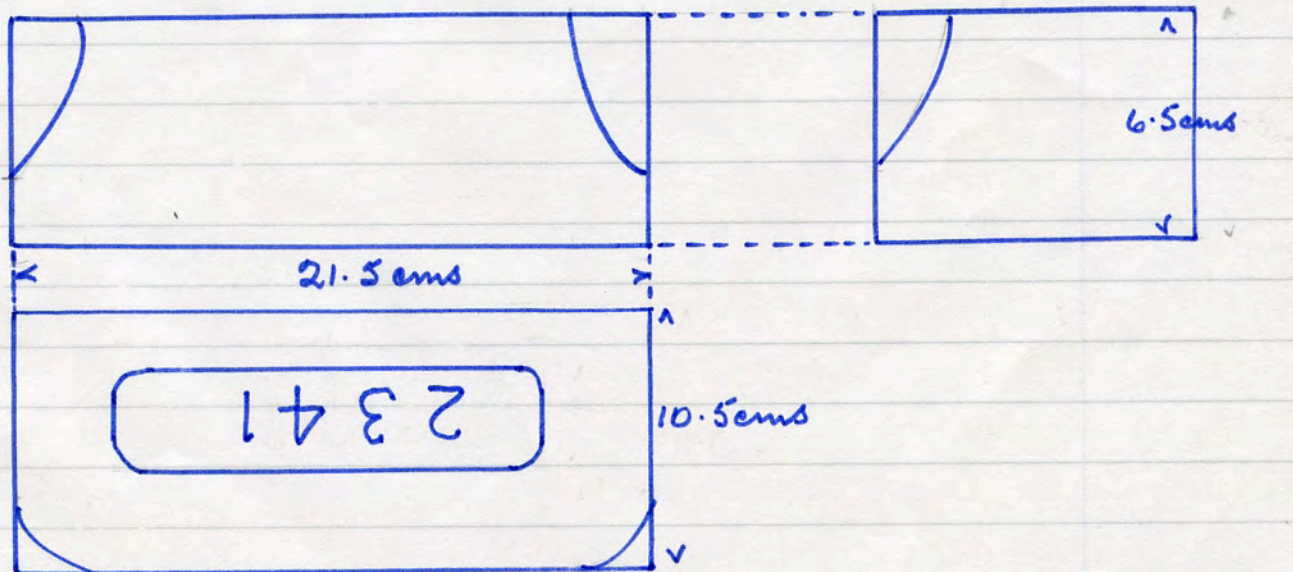

all above - Acceptor Mail dem. site 1. 8. '90

4839

actual size

No name 32 D 87
red. not dressed T.C.

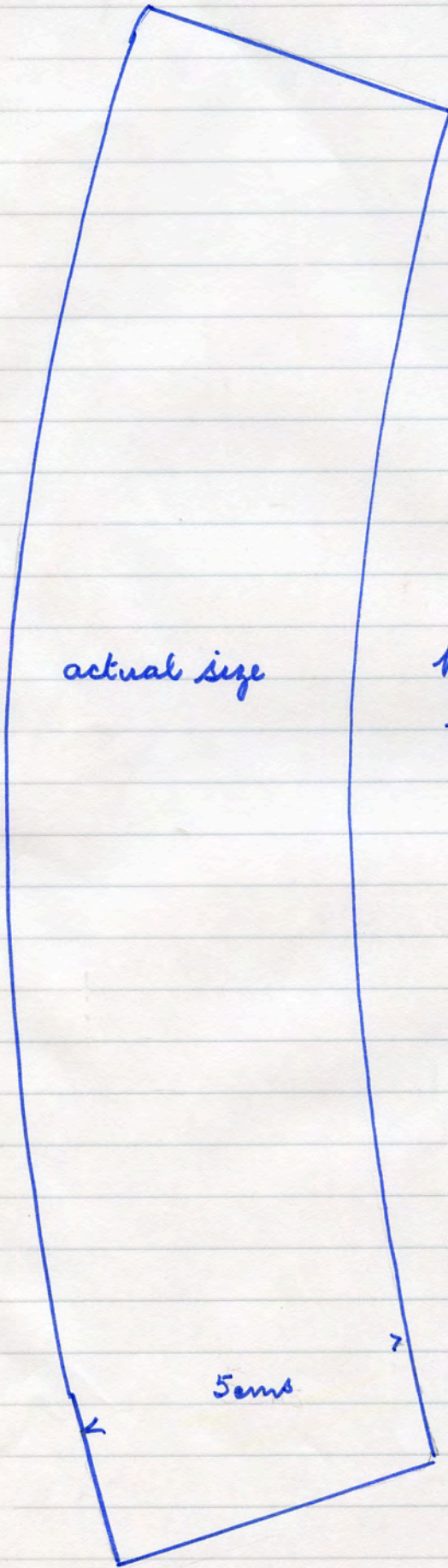

5cms

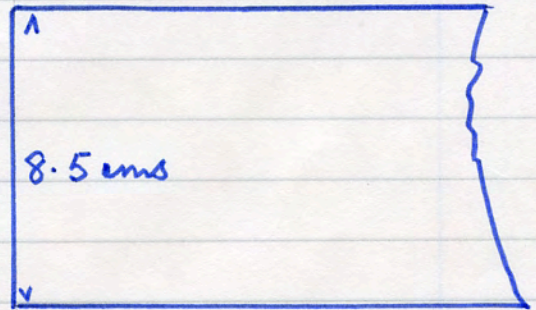

8.5cms

Acception Mori dem. site 1. 8. '90

No name 982 VR red brick. all edges wire run

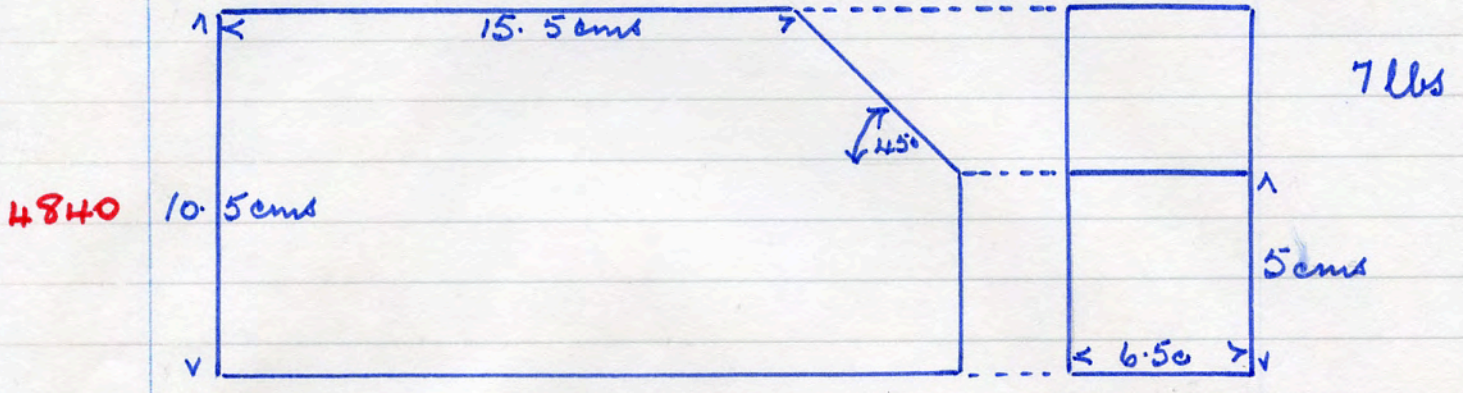

No name 603 U39 red. 2 face sides finished T.C.

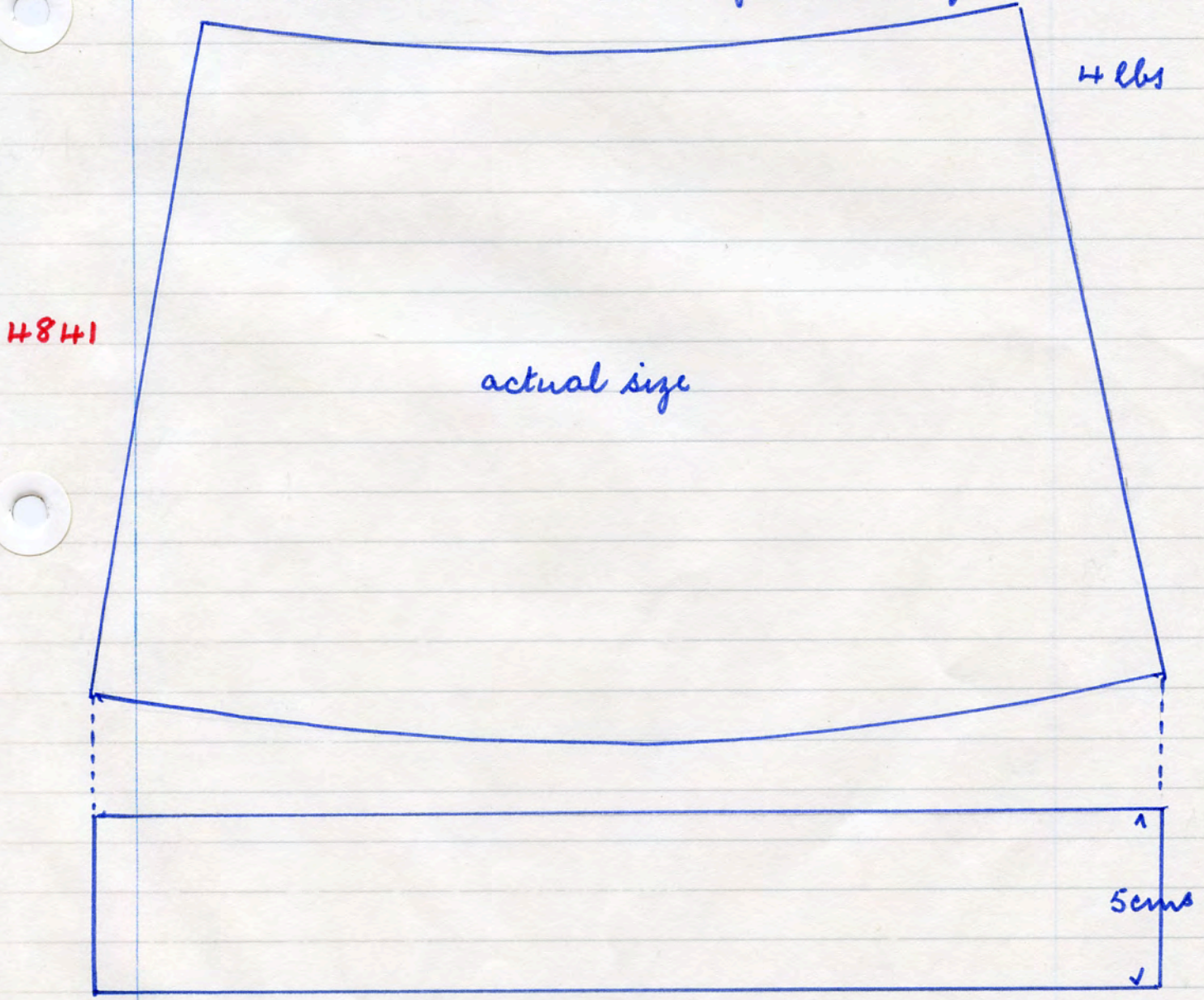

Above - Acpton Mari dem. site 1. 8. '90

No name FDX red. wire run. 2 face sides & 1 edge faced T.C.

6 1/2 lbs

4842

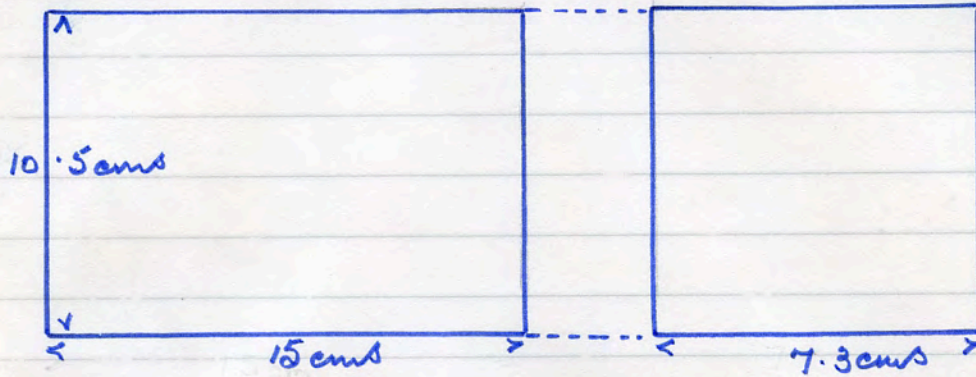

No name 349 TA^L red

9 1/2 lbs

4843

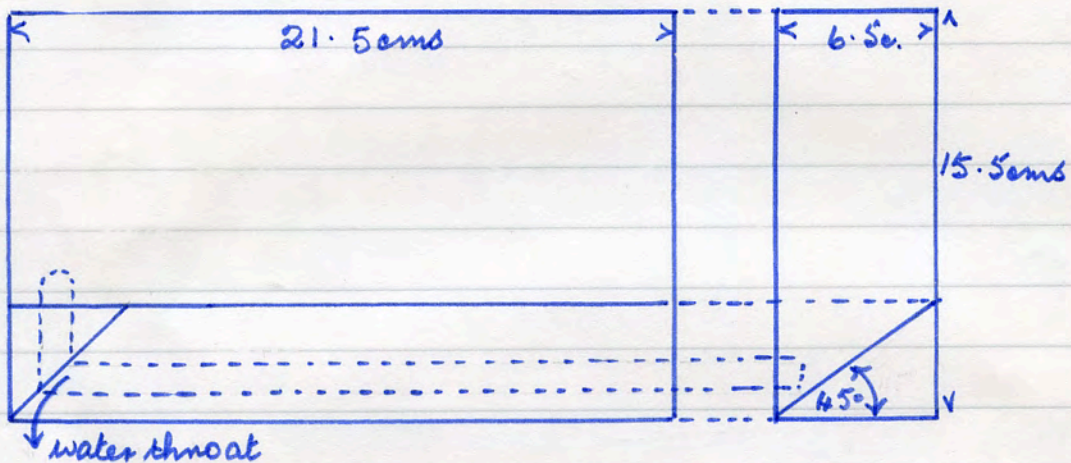

No name 183 U17 red 3 face edges dressed T.C.

14 lbs

4844

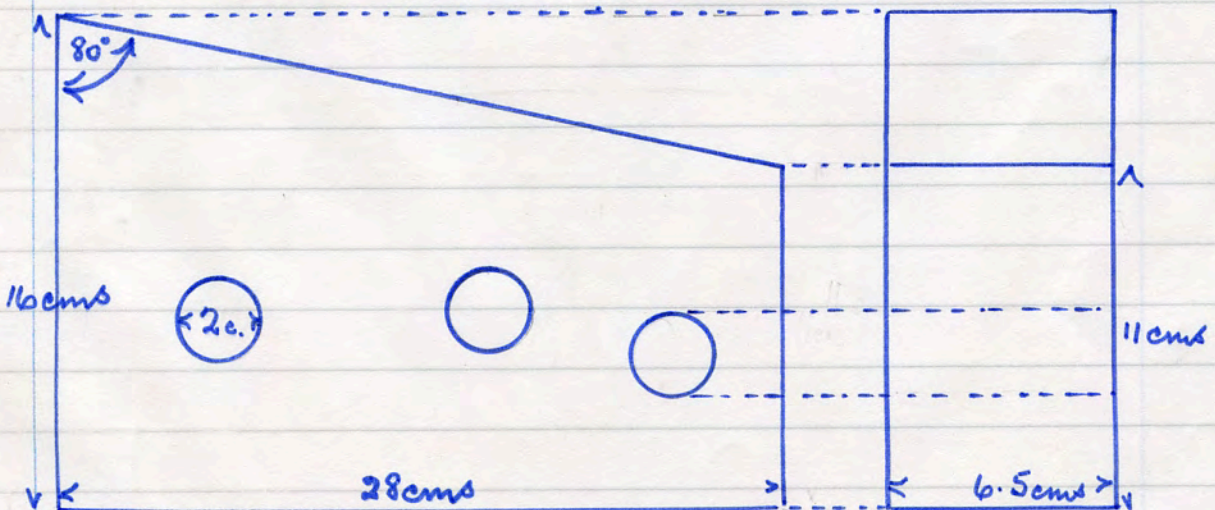

All above - Acceptor Maxi dem. site 1. 8. '90

No name 214 TB red. not dressed at all with T.C.

4845

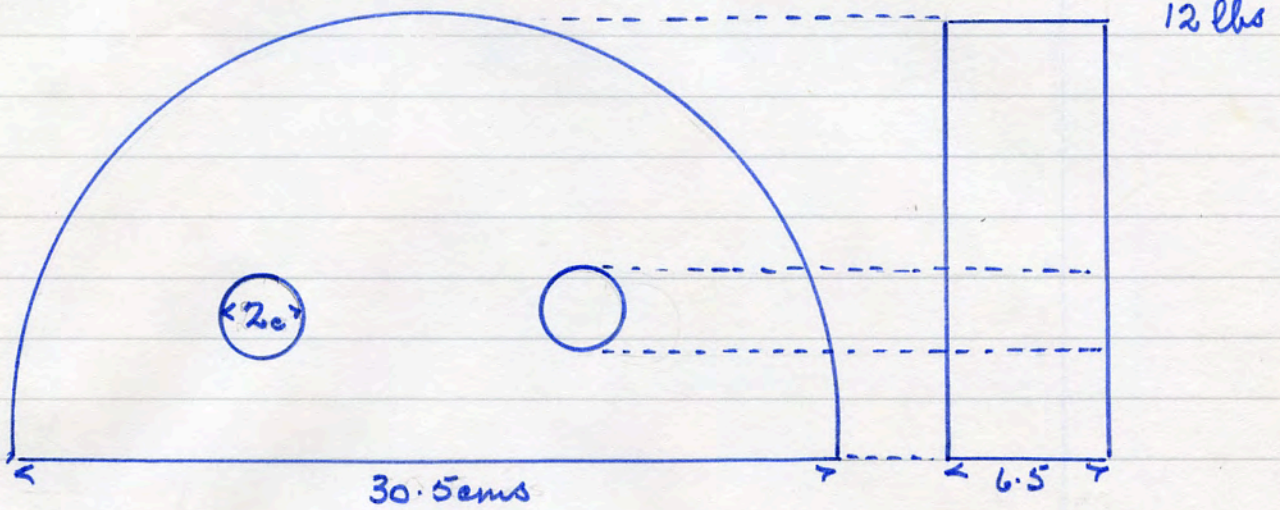

No name 78 PA red 3 face edges dressed T.C.

4846

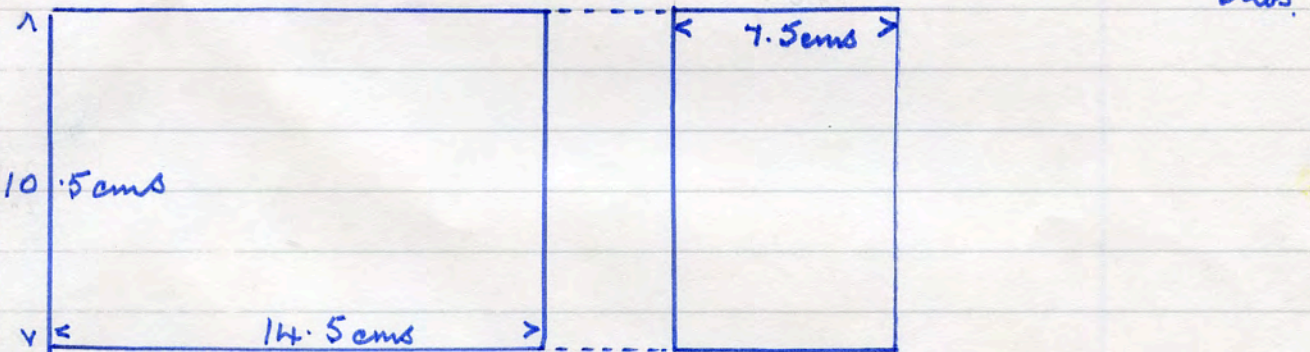

4847

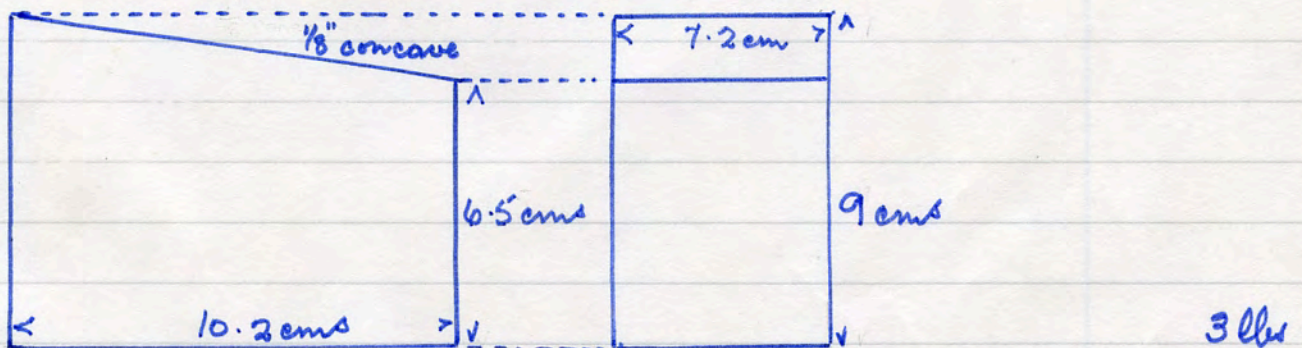

No name 52 P 846 red. 3 face edges dressed T.C.

All above - Section Mori dem. site. 1. 8. '90

No name 52 P 862 red 2 edges finished in T.C 7lbs

4848

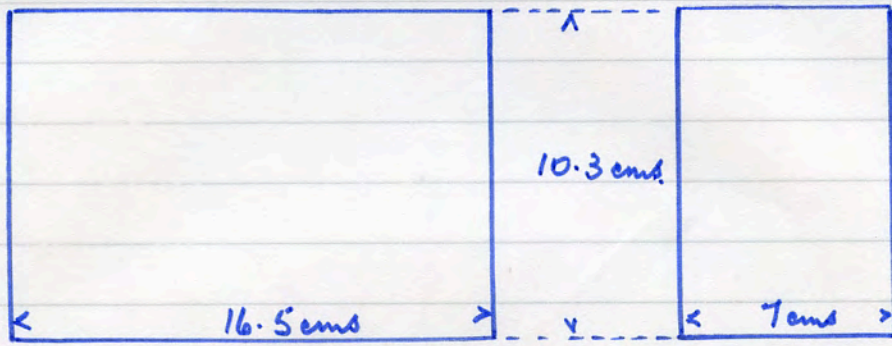

No name. 868 VE red 1 end T.C. finish 7lbs

4849

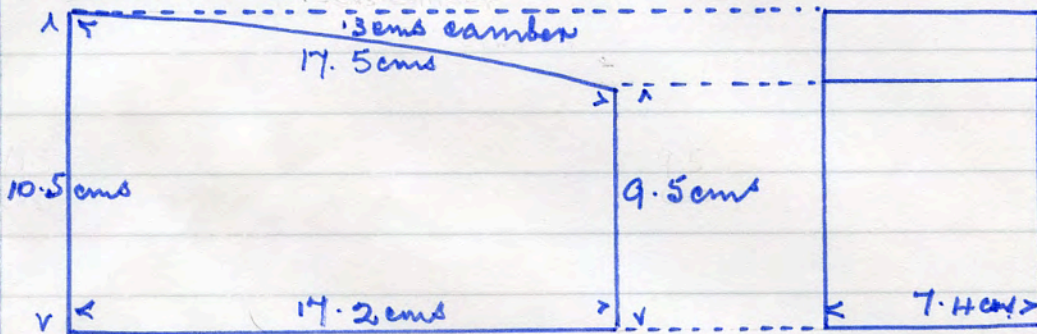

No name 60N 171 red 1 end 1 face side T.C. finish 7 lbs

4850

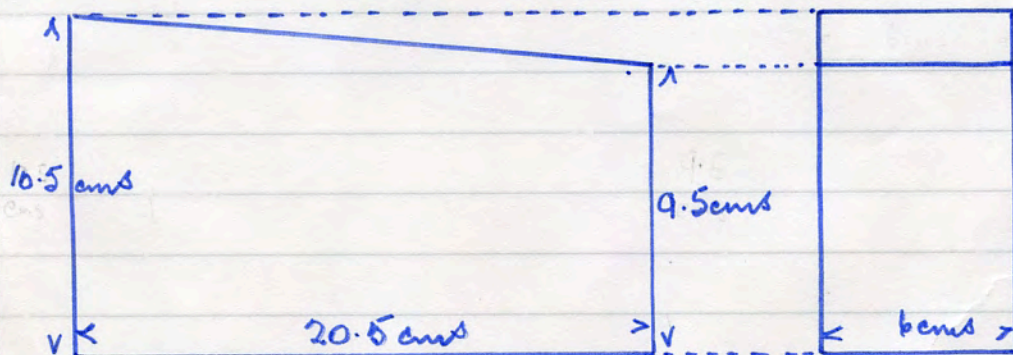

No name 35 F red 1 face side T.C. finish 8 lbs

4851

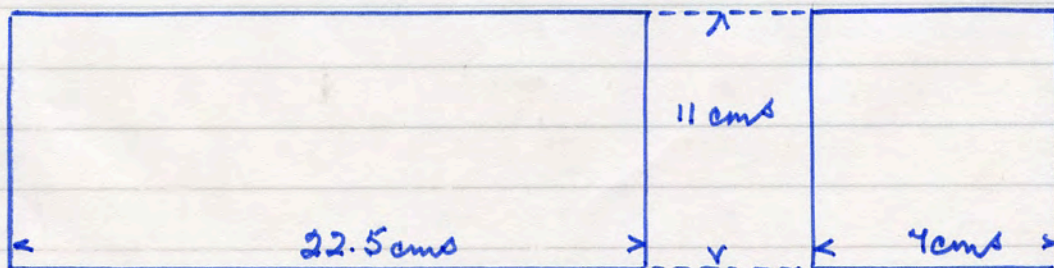

All above - Acc/ton Mori dem. site 2. 8. '90

No name 92 M 215 Δ 282 red edge faces dressed T.C.
 sides combed to assist cohesion of mortar

4852

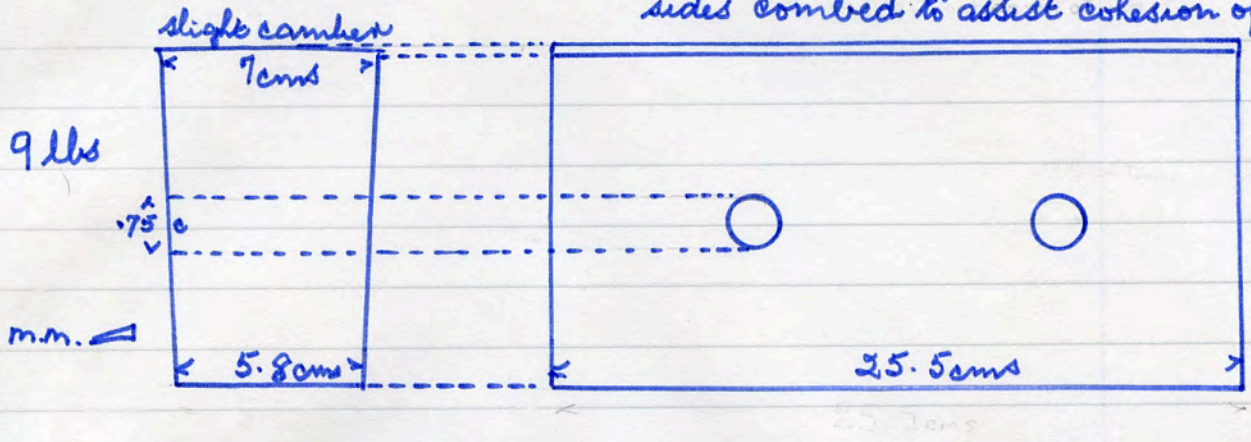

No name. 63 D 457 Δ 560 red. face edges dressed T.C.
 10 lbs.

4853

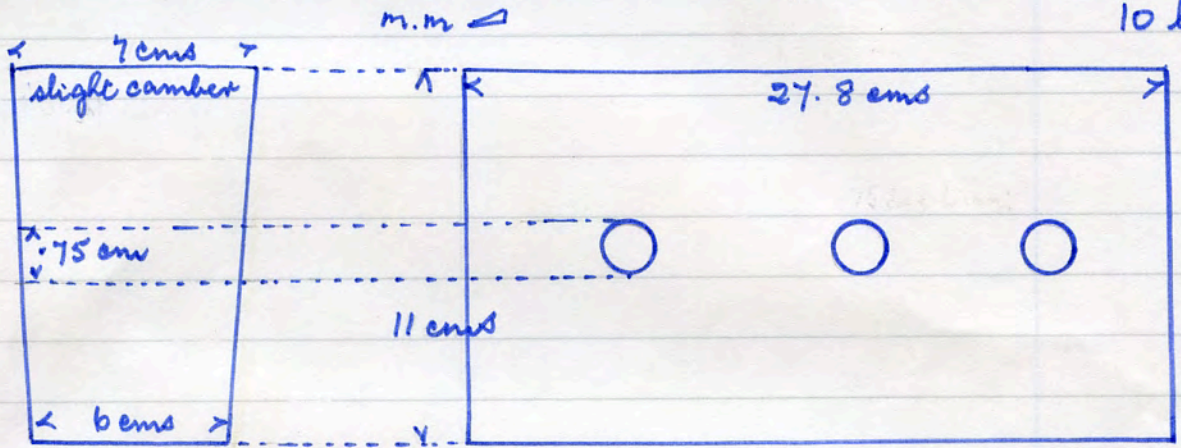

No name 1X red no T.C. dressing. all faces scratched
 9 lbs

4854

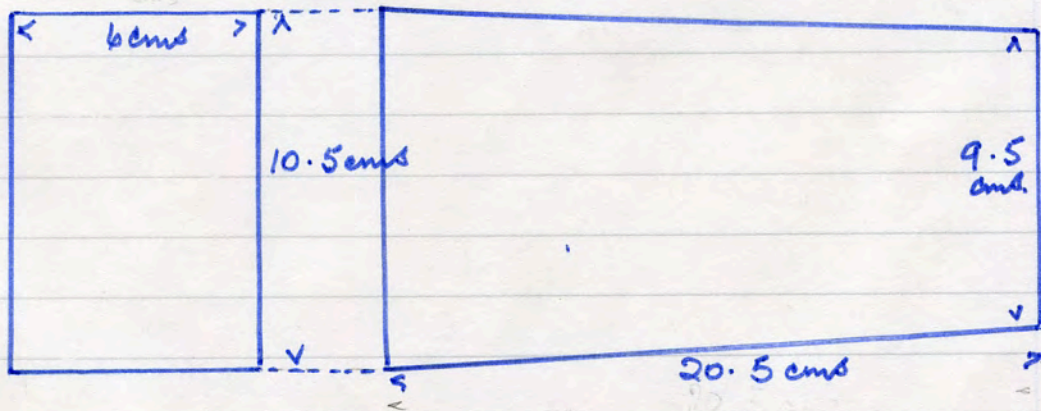

All above - Acceptor Hori dem. site 2. 8. '90

No name 169 T 9X red. wire run. base & 1 end smooth 11 1/2 lbs

4855

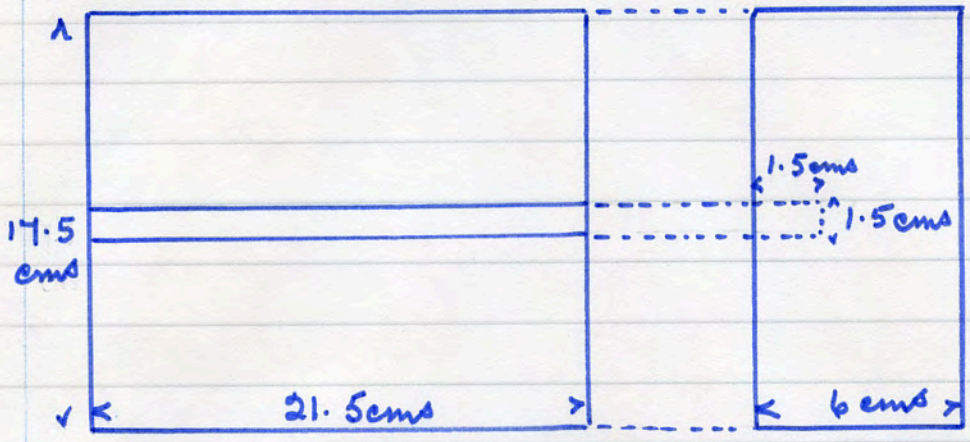

No name 927 V red T.C. dressed all round

14 lbs

400
4856

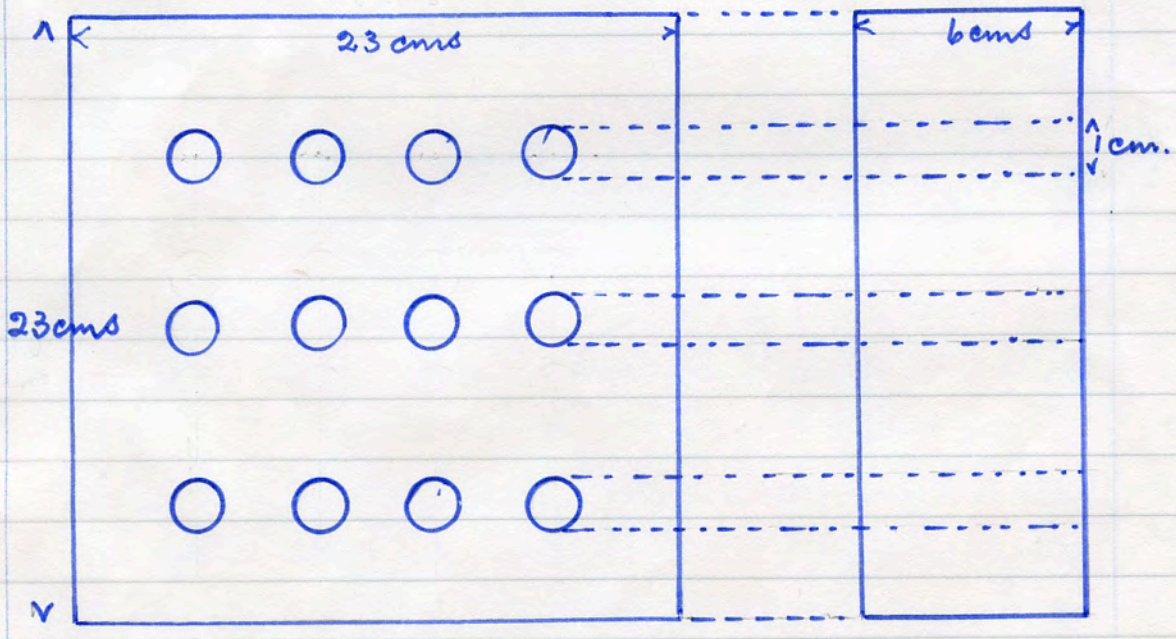

Both above - Acceptor Mori dem. site 2. 8. '90

No name 38 Q 17 red 1 face side only T.C. finish
16 lbs

H857

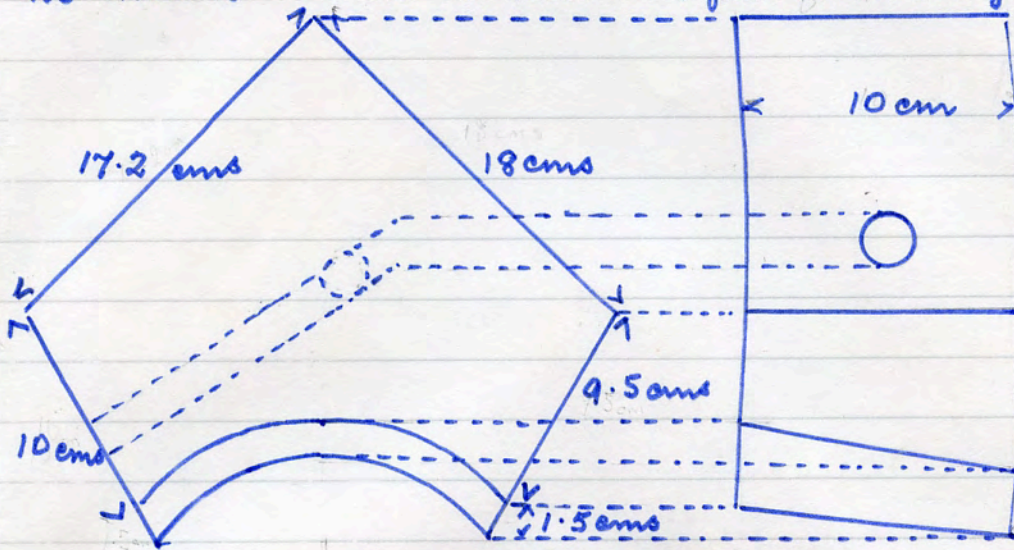

No name 329 U2 red inside surface only dressed T.C
14 lbs

H858

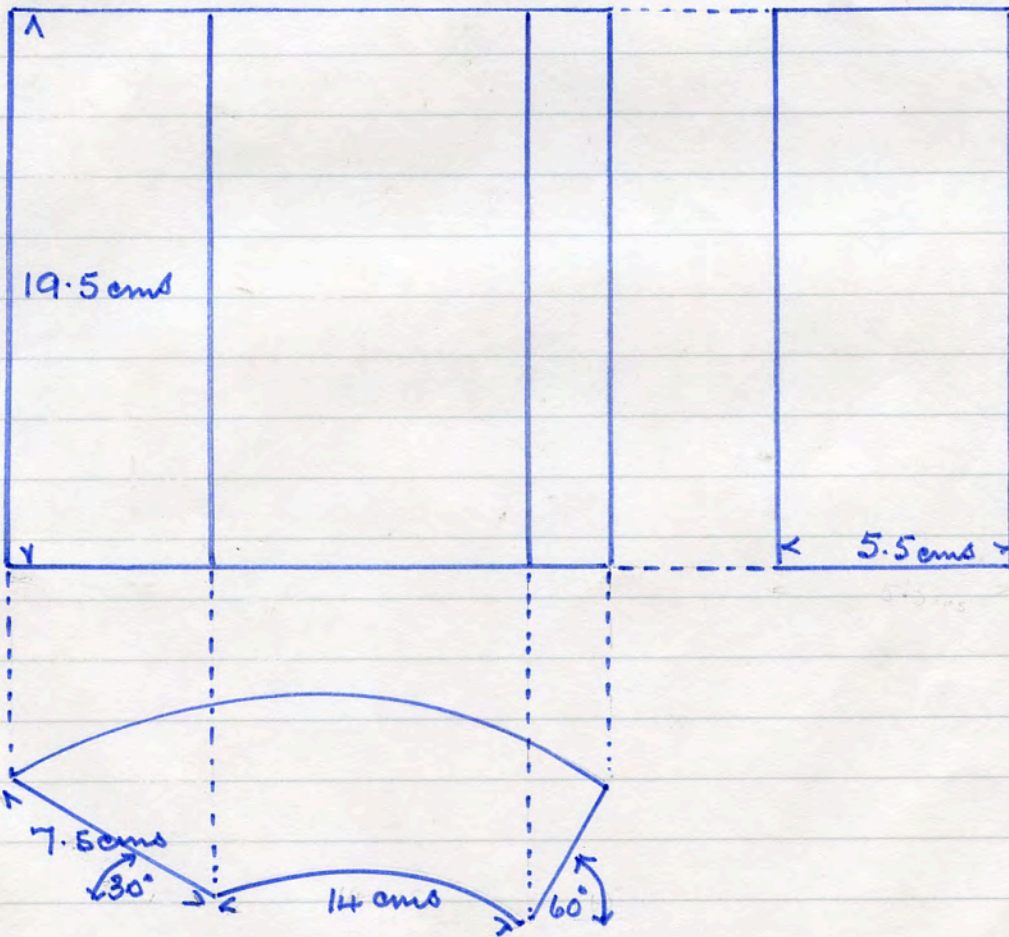

Acceptor Mexi dem. site 3. 8. '90

4859 No name 64 L1 red face side & top edge dressed T.C. 8 lbs

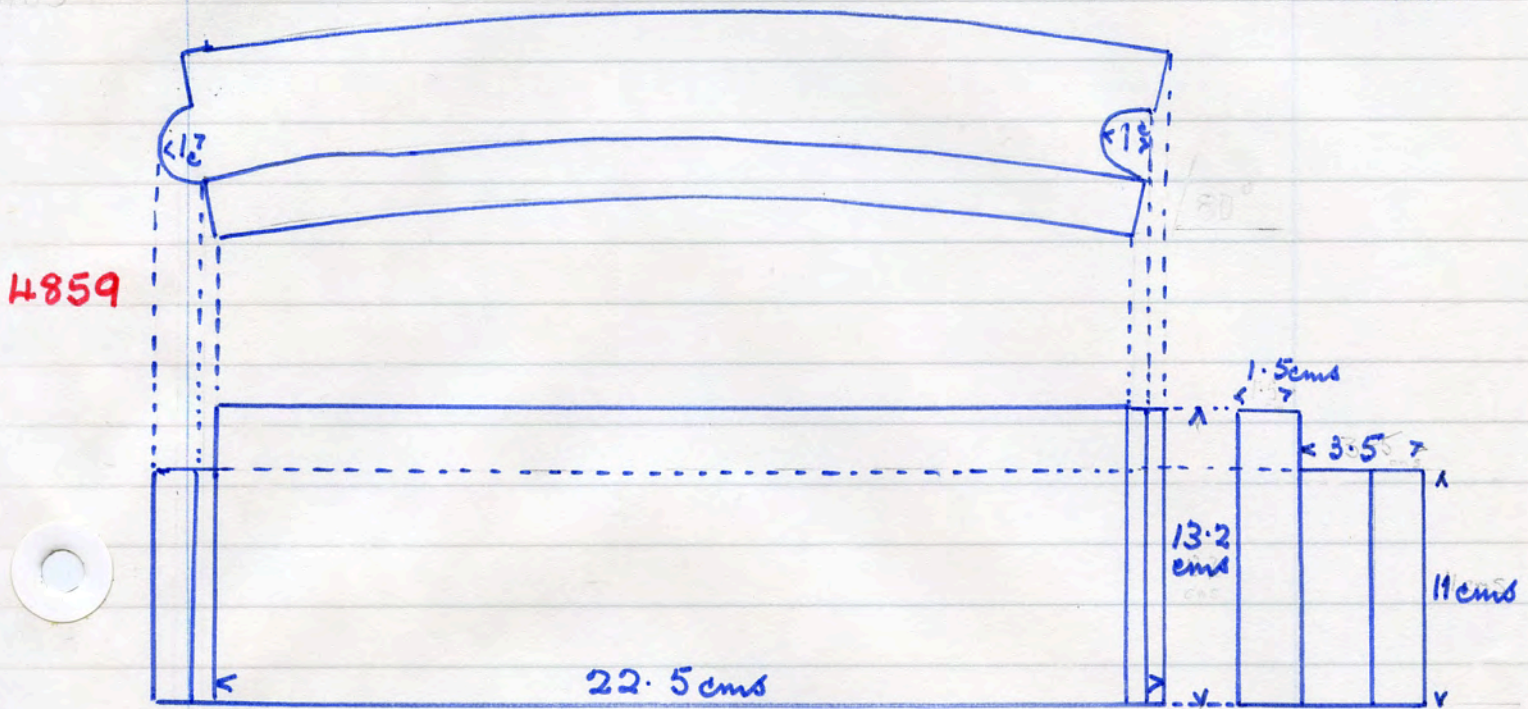

4860 No name 75 G 10 red inside face only dressed T.C.

moulder's mark TH
14 lbs

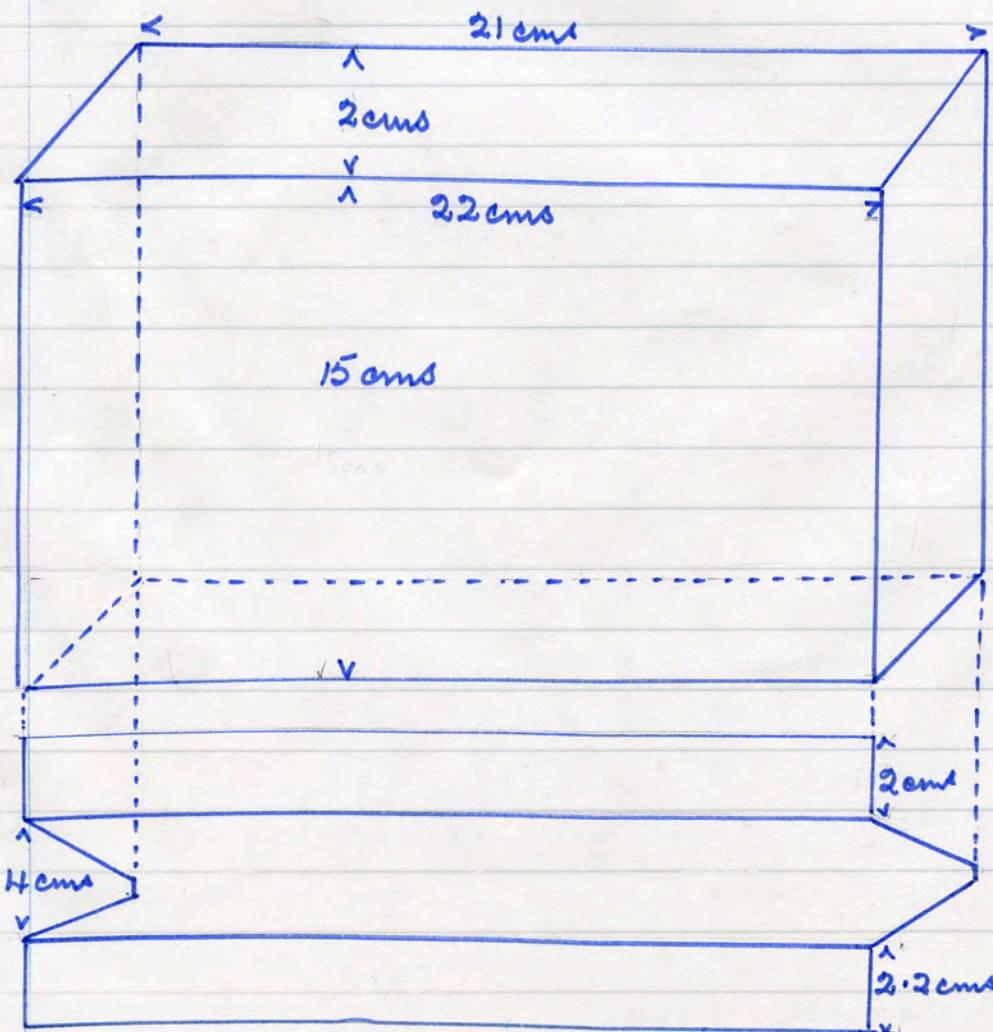

Accl'ton Mori
deur. site
3. 8. '90

No name 27 G 26 red 1 face edge only T.C

all axes pencil
mould
7 lbs

4861

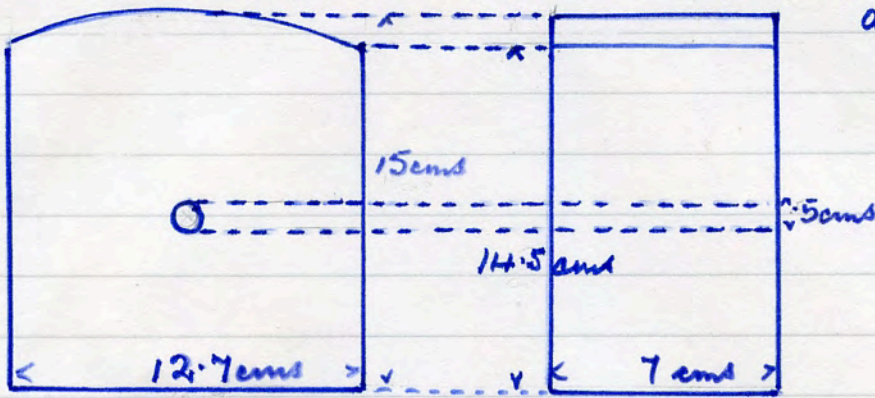

No name 96 C 22 red. 2 face edges & 1 face end T.C

7 lbs

4862

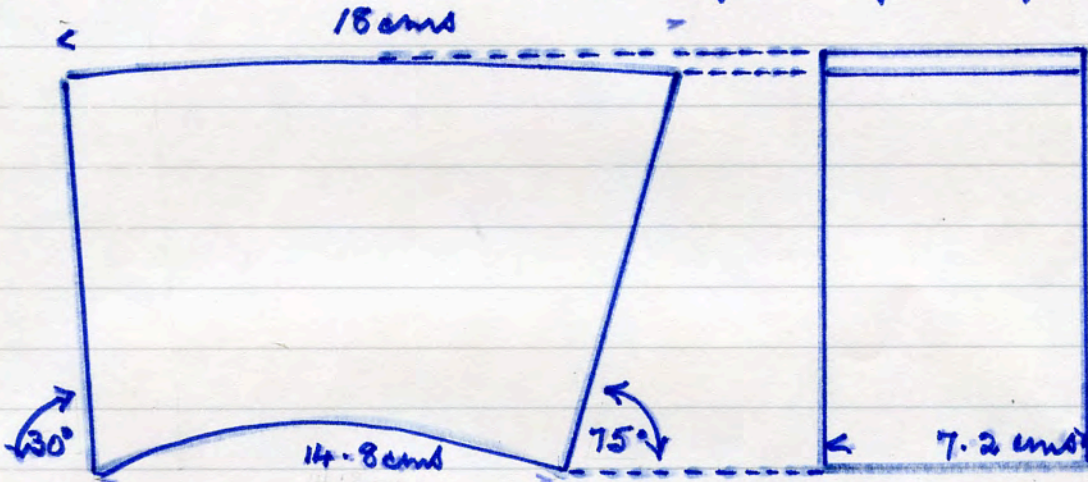

No name 67 P 12 red. 2 face ends T.C.

6 lbs

4863

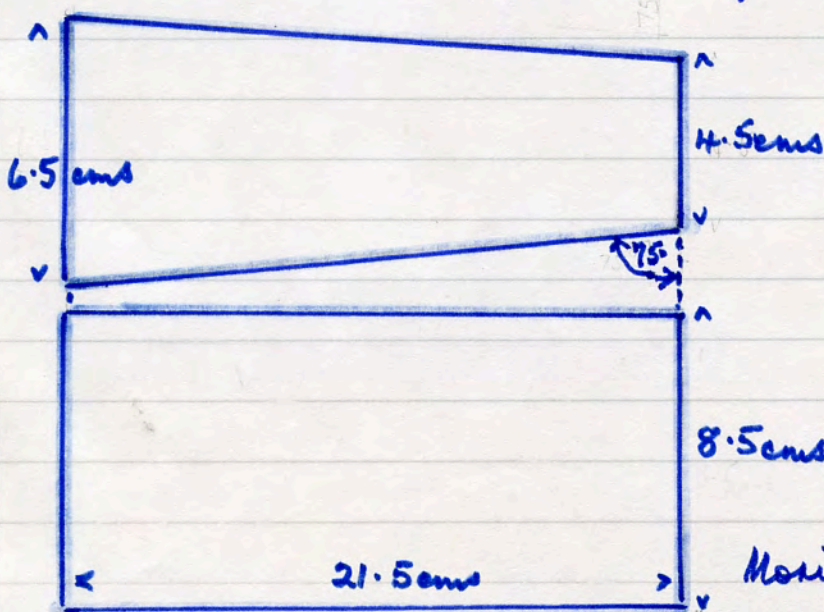

All above - Acpton
Mori dem. site 3. 8. '90

No name 462 UE red face end + 2 face edges T.C

4864

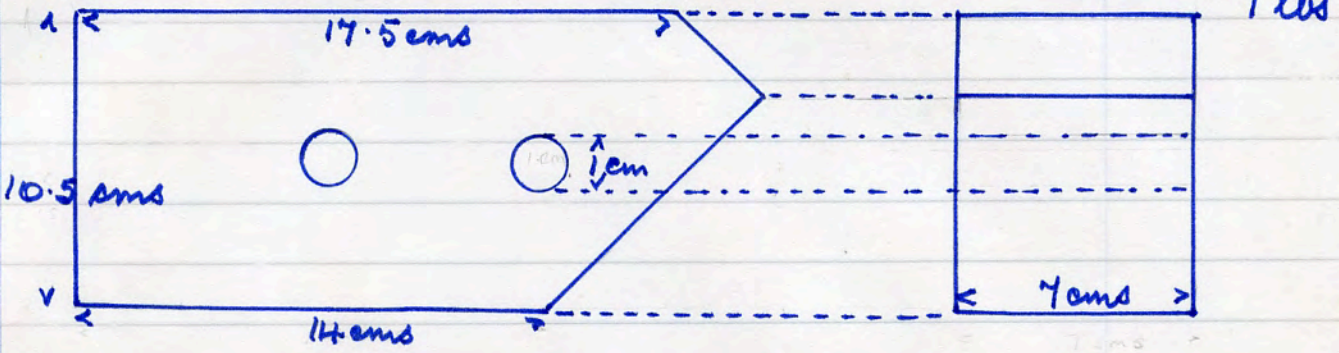

No name 358 T red. chamfered return
8 1/2 lbs. all face edges + return end T.C

4865

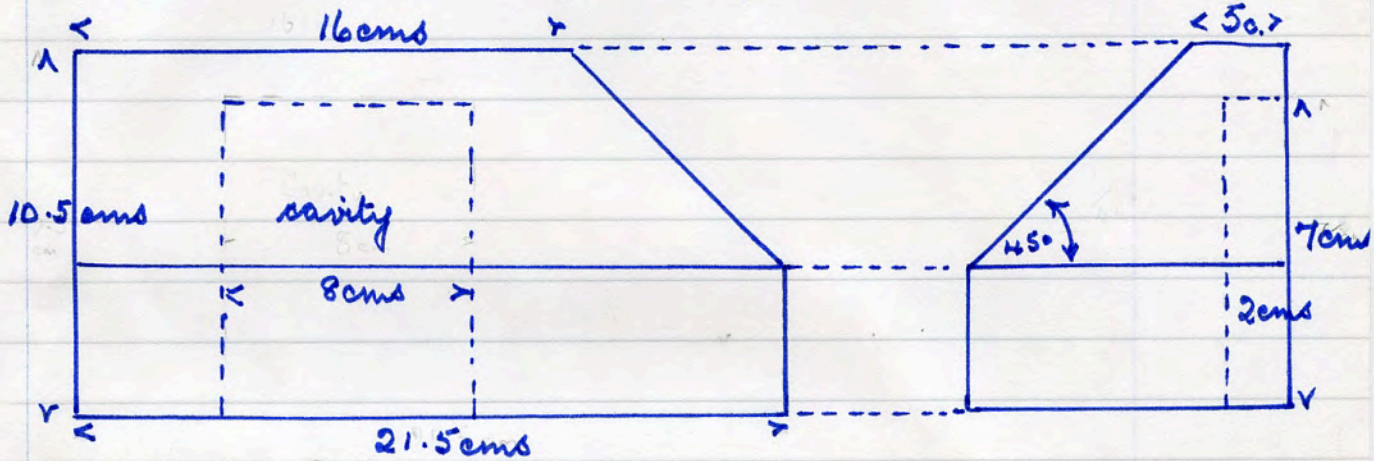

No name 96 C 11 red T.C. small circular segment
with moulded section 7 1/2 lbs

4866

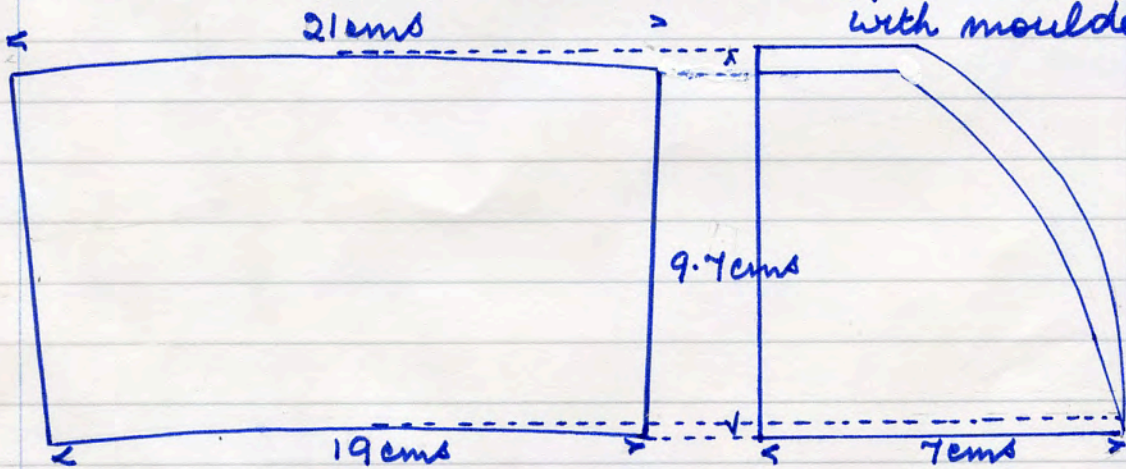

All above - Acceptor No. 11 dem. site 3. 8. '90

No name 576 UA red. 2 faces wire run, others T.C.

4867

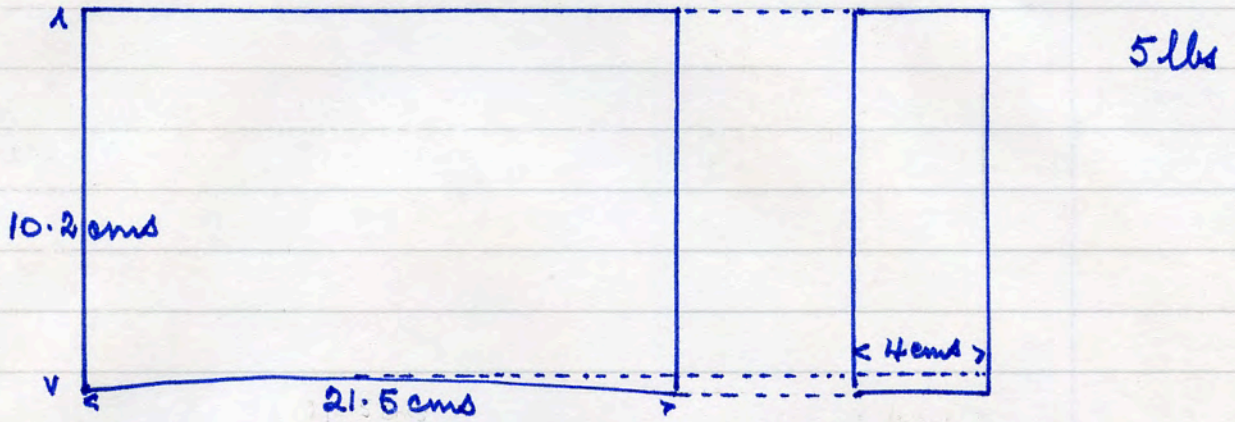

No name Z17 PP red. wire run

4868

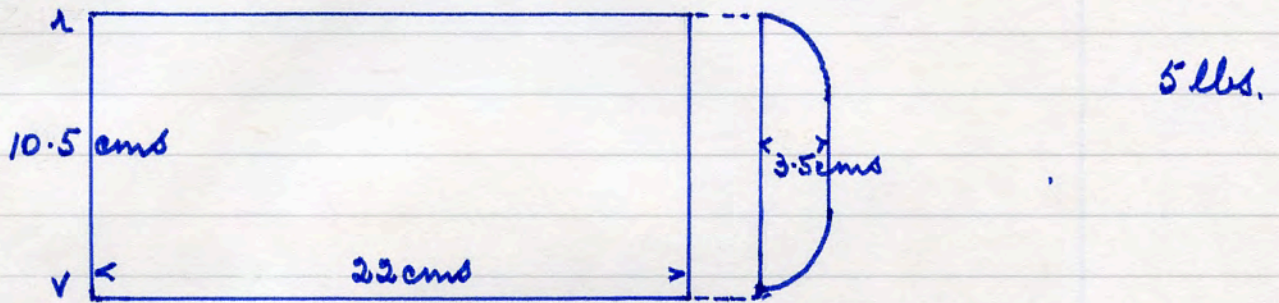

No name 1 CBD red wire run

6 1/2 lbs.

4869

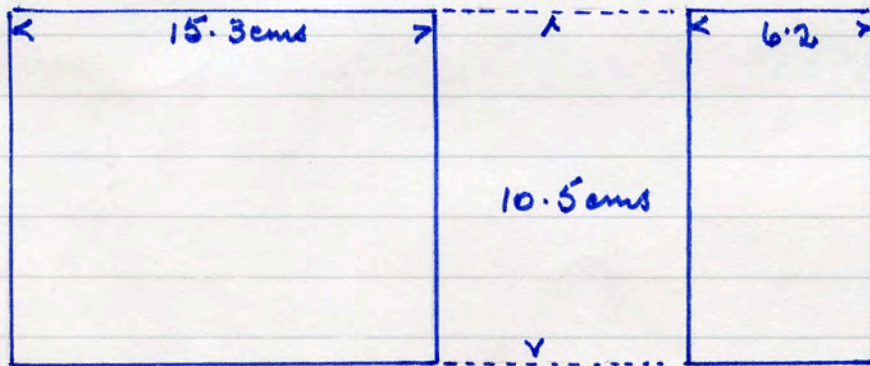

No name 289 V5 red 1 face edge + end T.C

9 1/2 lbs

4870

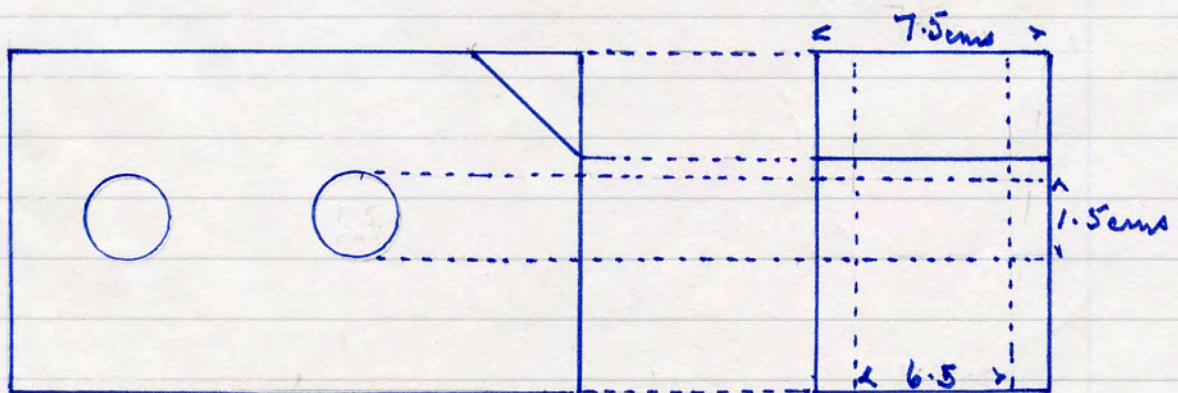

All above - Acc/ton Mori dem. site.

knapsing to

4. 8. '90

No name 76 PG red all sides wire num. face edge T.C.

4871

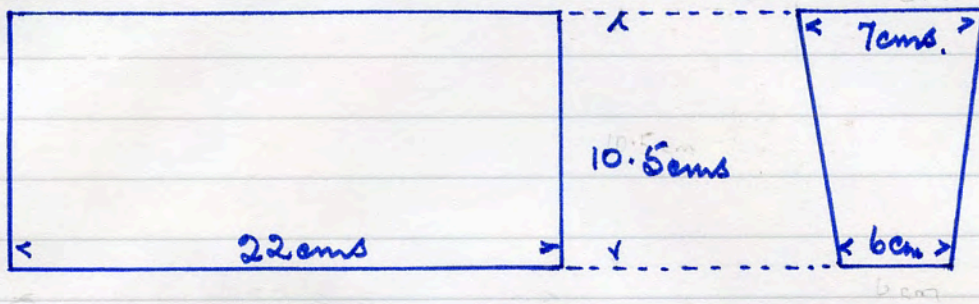

8 1/2 lbs.

4872

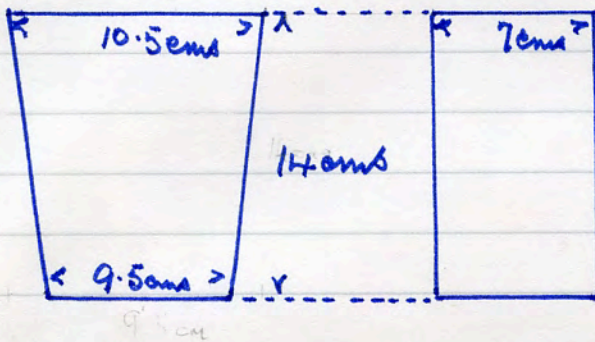

No name 57 R 14 red

part of face sides combed
1/3 rest T.C. treated
6 lbs.

4872

No name 810 R red internal edge wire finish,

external edge smooth

4873

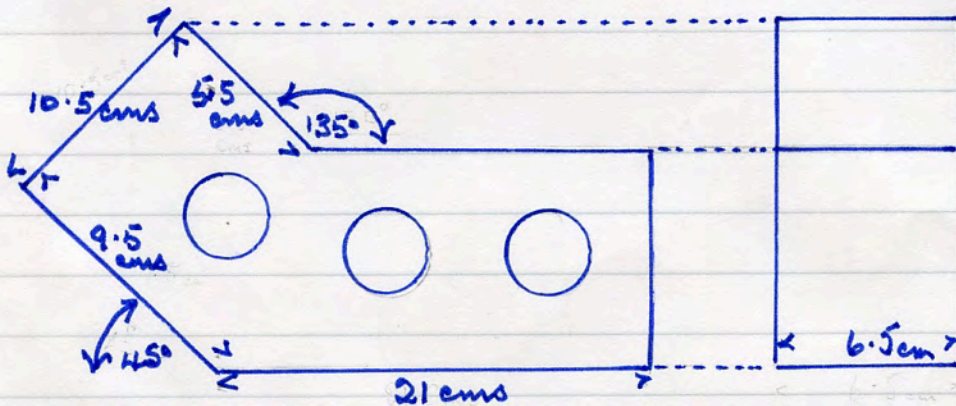

9 lbs.

All above - Acpton Mori dem. site.

4. 8. '90

No name CBD red wire run 2 face sides T.C.
6 lbs.

4874

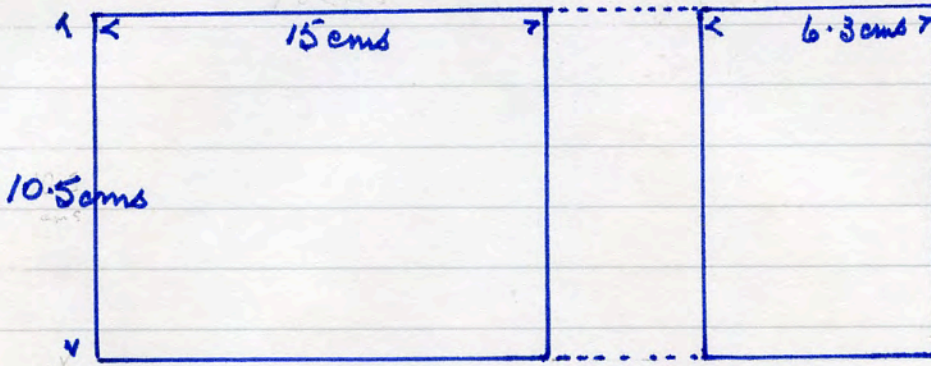

No name 937 ZR red. 1 face side 1 end 1 edge T.C.
right hand mitred end to mould. 7 lbs

4875

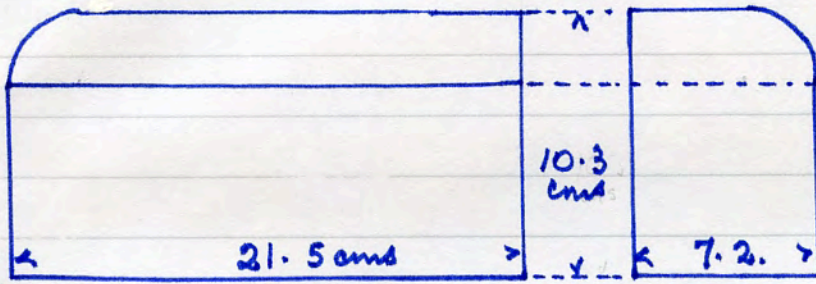

No name 937 ZL red. specifications as 4875
left hand

4876

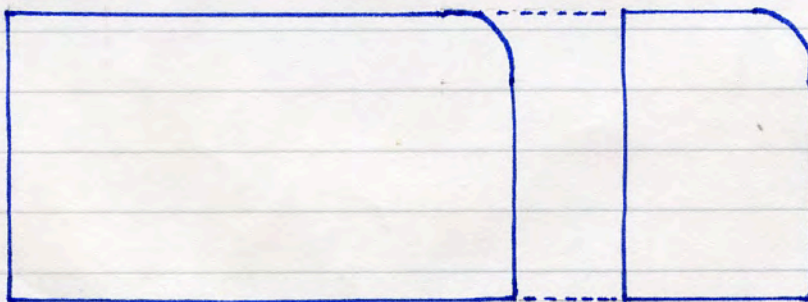

No name 5R red. wire run starter blk for jamb
1 edge T.C. finish

4877

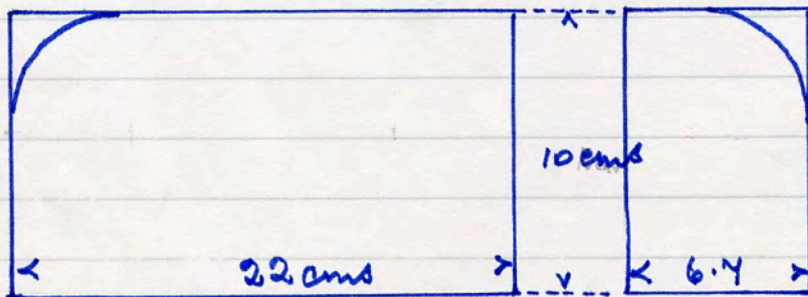

7 lbs.

All above - Acpton Mori dem. site 4. 8. '90

No name 968 V red face 4 return end T.C.

4878

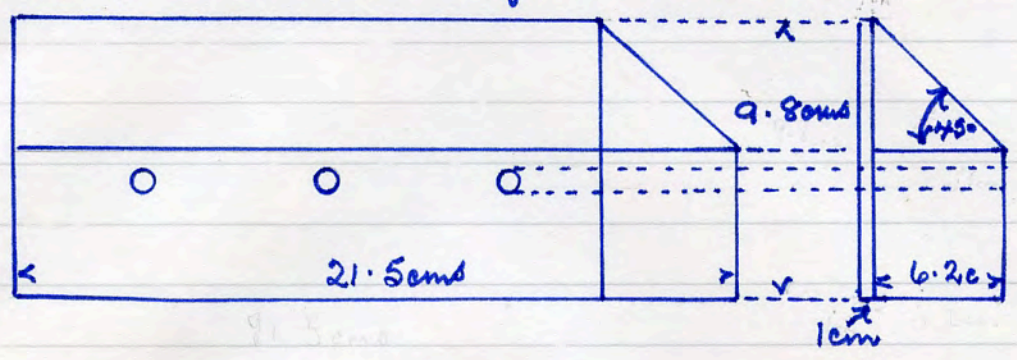

4 lbs

No name 197 TL. Bowland Brown all faces T.C finish left hand rest wire run. 6 lbs

4879

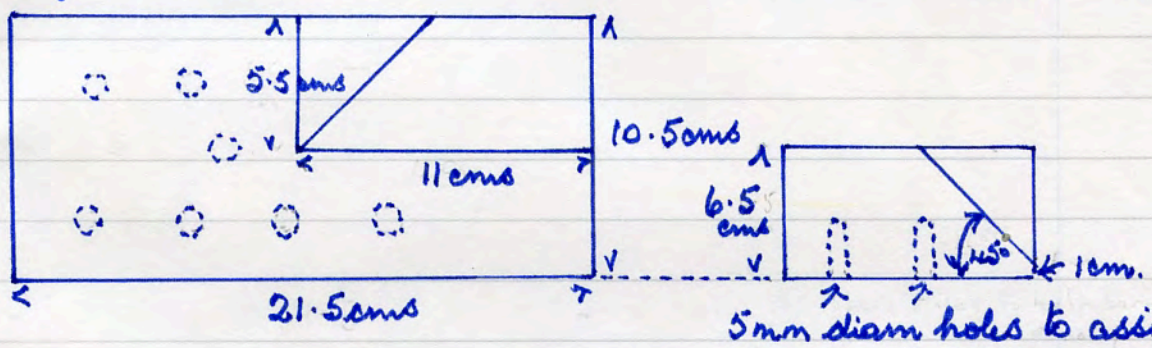

burning

No name 197 TR Bowland Brown. all faces T.C. finish right hand to above 4879. 6 lbs

4880

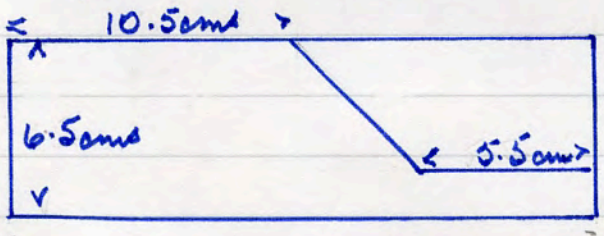

No name 2541 CR Bowland Brown. all faces + return end T.C. finish 6 lbs

4881

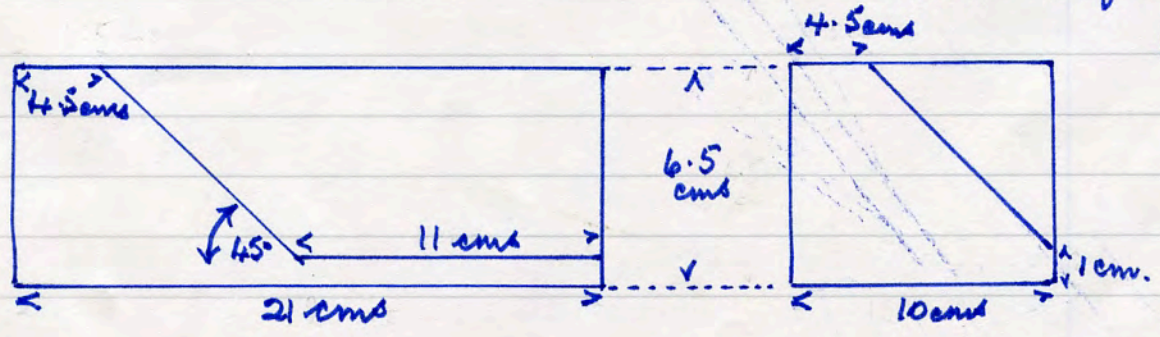

All above - Acpton Mori dem. site H. 8. 90

No name 239 2LD Bowland Brown wire run
mitred end & return

4882

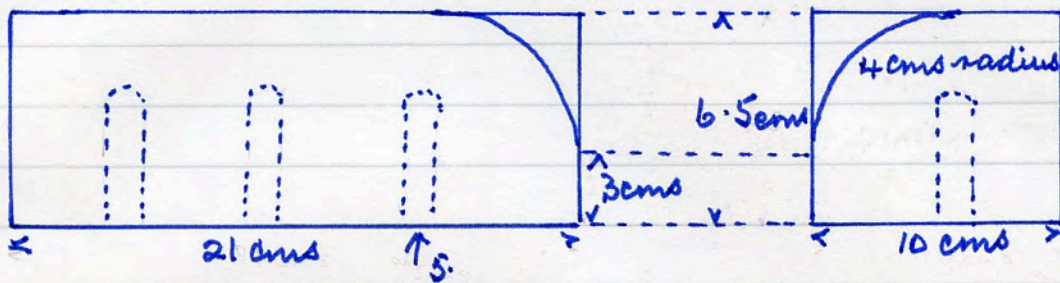

6 1/2 lbs

No name 239 2RD Bowland Brown. wire run
specifications as 4882.

4883

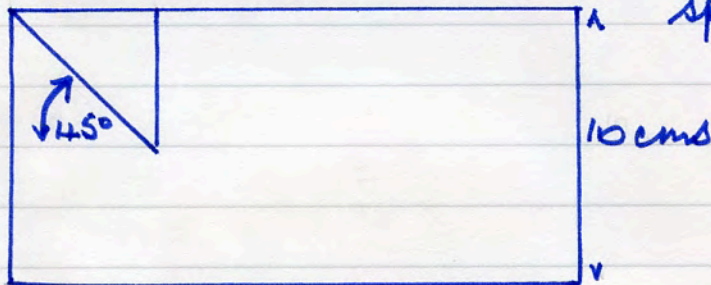

6 1/2 lbs.

No name 257 2DL Bowland Brown wire run.

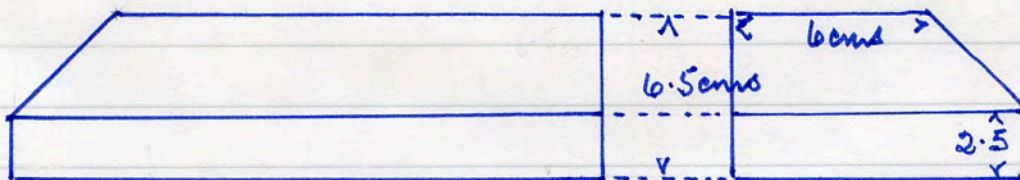

6 lbs

4884

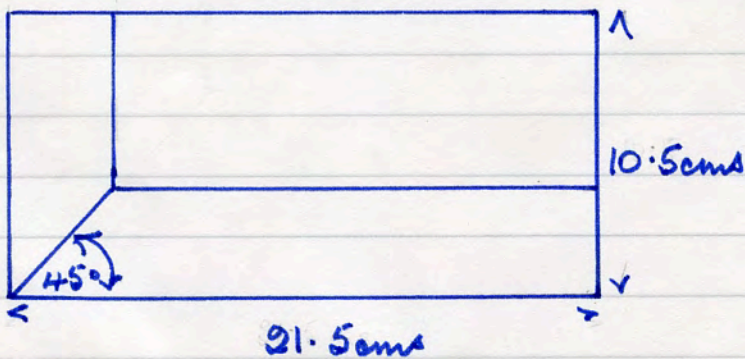

All above - Acpton Nani dem. site 5. 8. '90

No name 2511 LD Bowland Brown wire run
left hand

4885

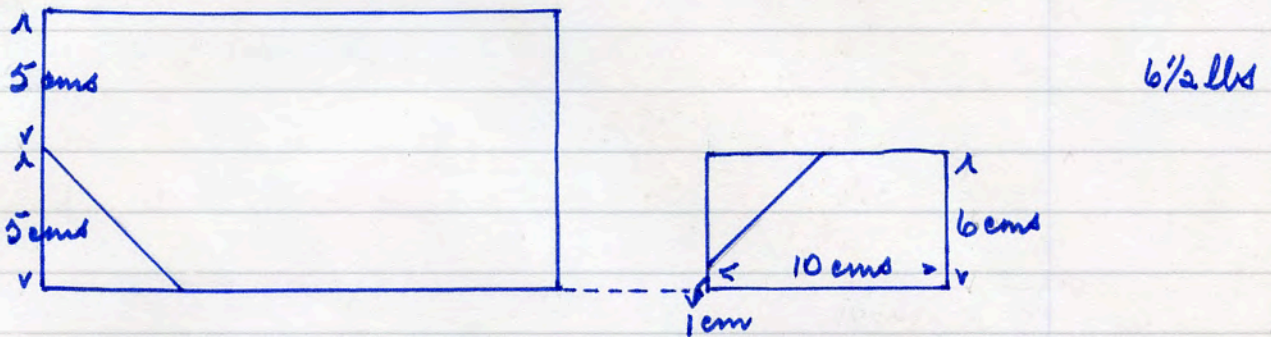

No name 2511 RD right hand to above

4886

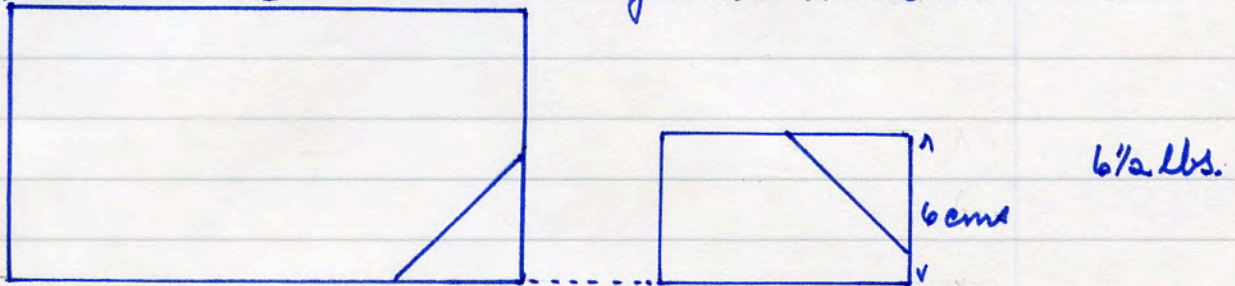

No name 57 R11 red. wire run except top and
bottom edges

4887

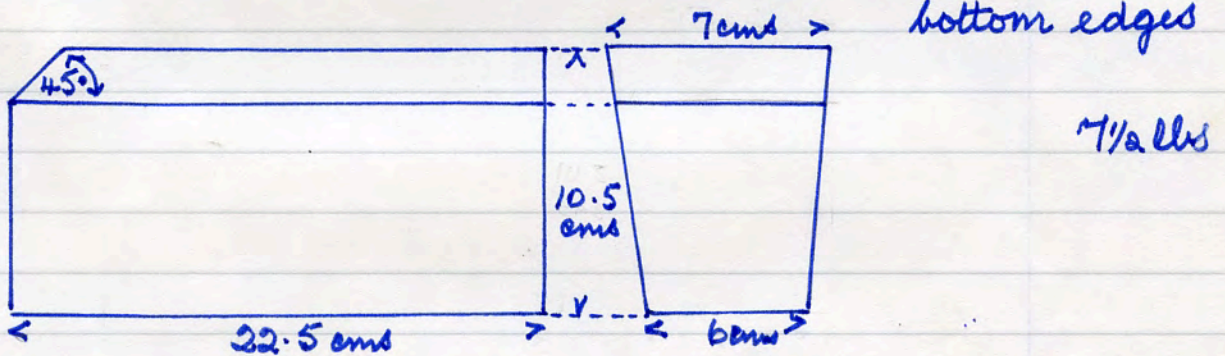

No name 21 VFR red 1 face side. 1 face edge T.C
the rest wire run.

4888

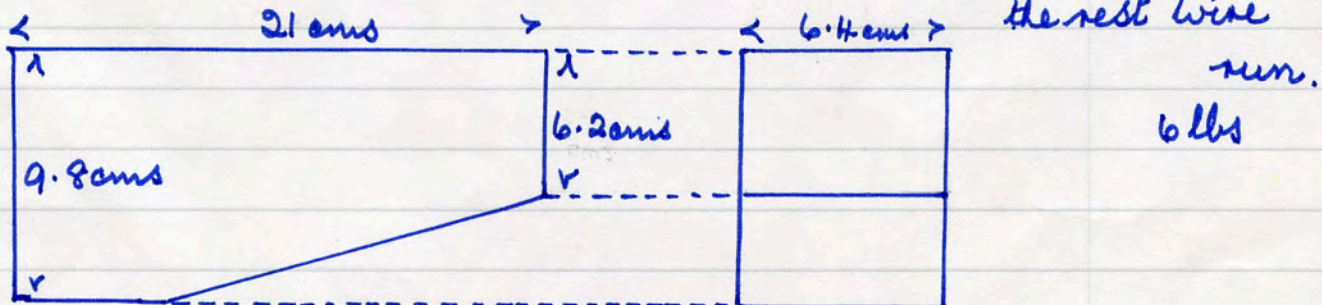

All above - Acpton Mori dem. site 5. 8. '90

No name 75 N red internal face edge only T.C. finish

4889

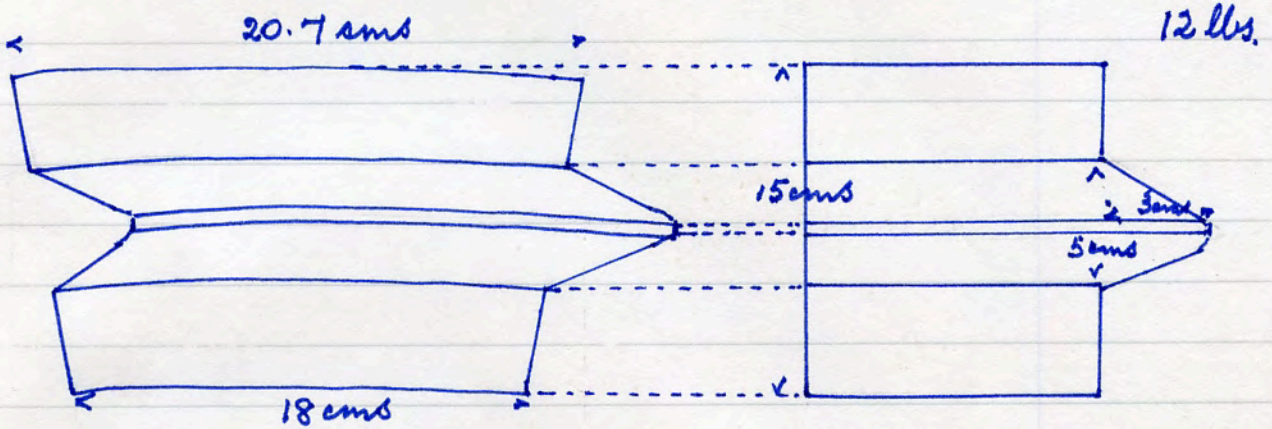

No name 75 NA red specifications as above. 9 lbs.

4890

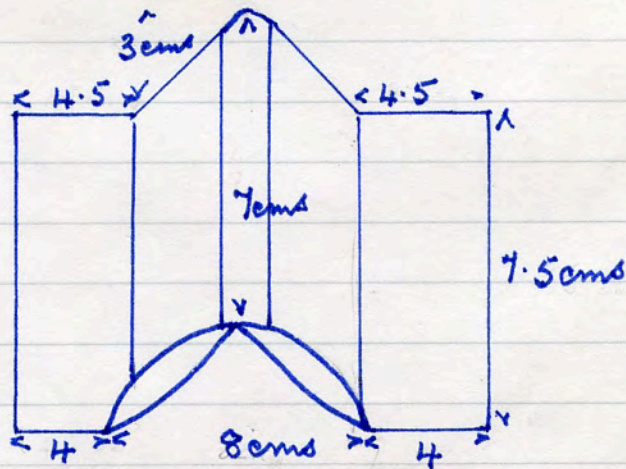
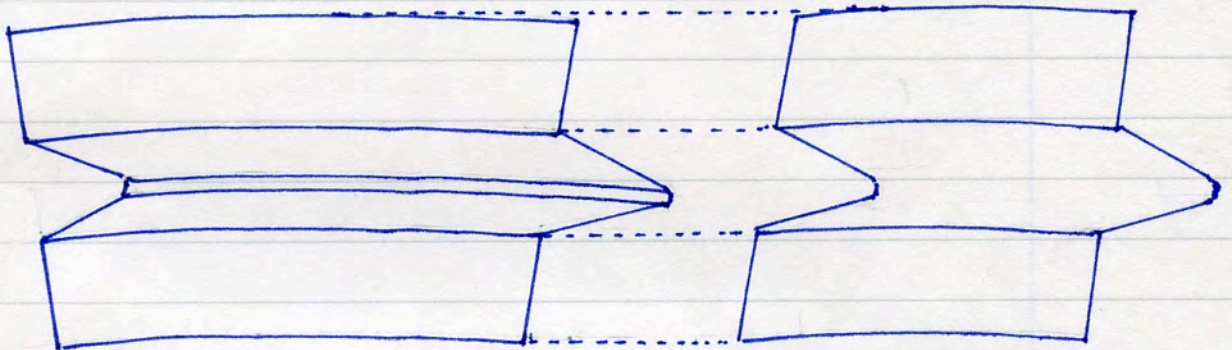

Both above - Acceptor Horni dem. site 6. 8. '90

No name 2372 LD Bowland Brown wire run 7 lbs

4891

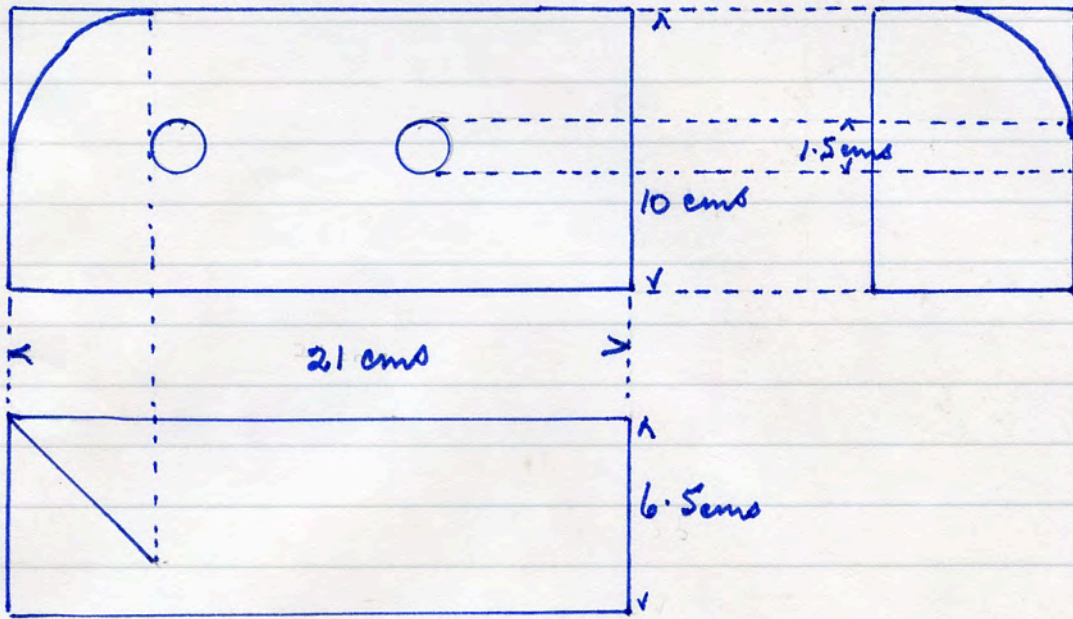

No name 2332 DL Bowland Brown wire run 7 1/2 lbs

4892

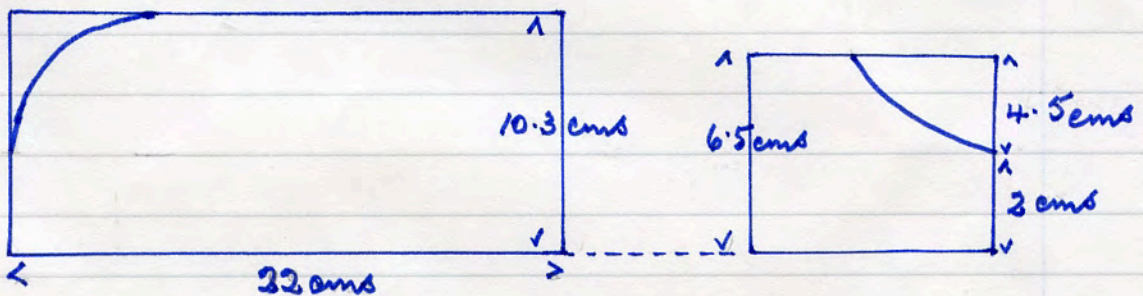

No name 2522 FEC Bowland Brown T.C. all round 7 lbs

4893

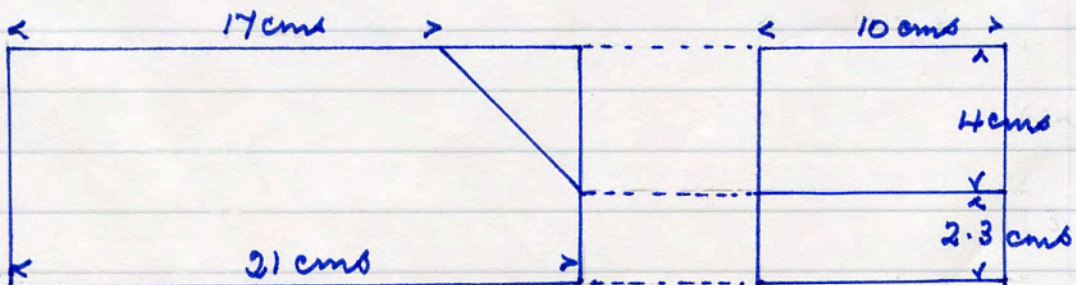

All above - Acceptor Mori dem. site 6. 8. '90

No name 2532 FEC Bowland Brown T.C. all round 6 1/2 lbs

4894

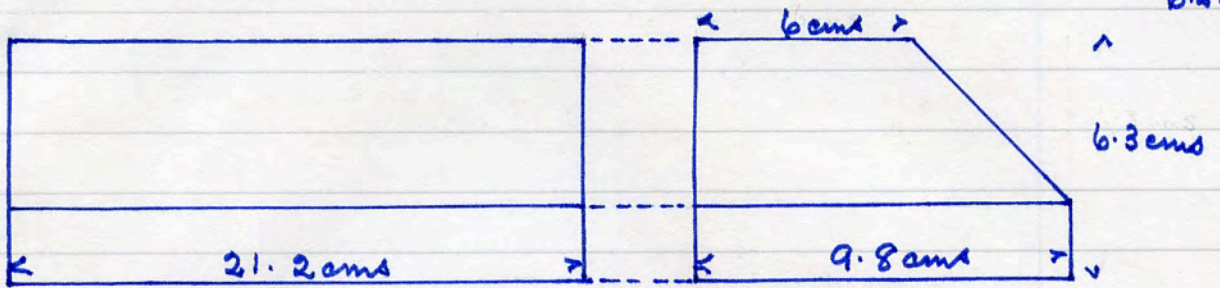

No name 237 TBR red T.C. all round

4895

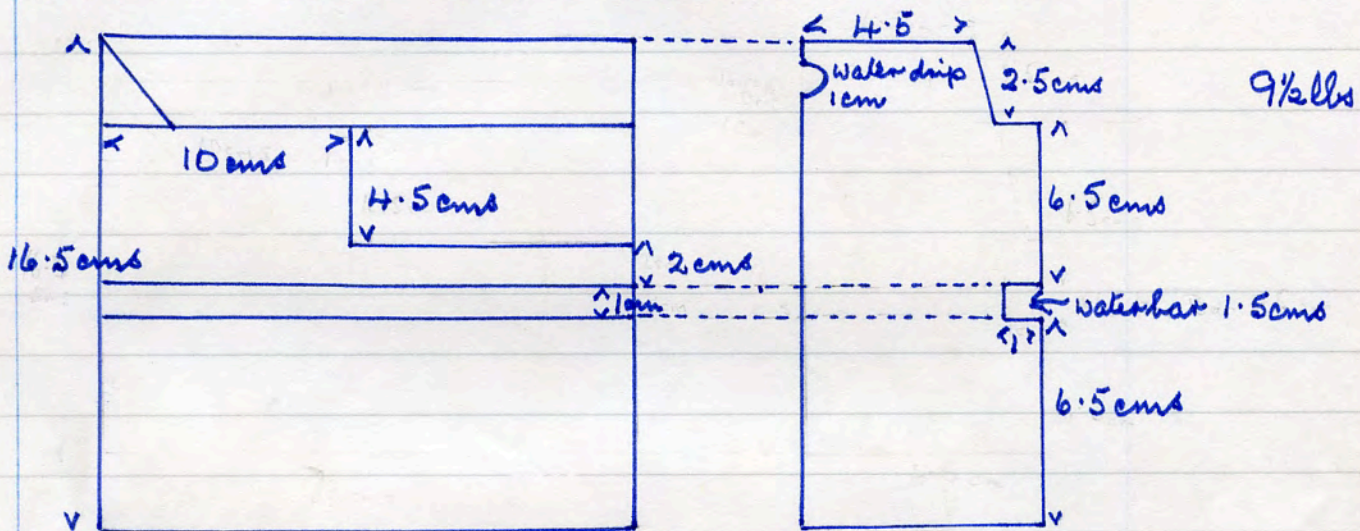

No name 242 TB red T.C. all round

4896

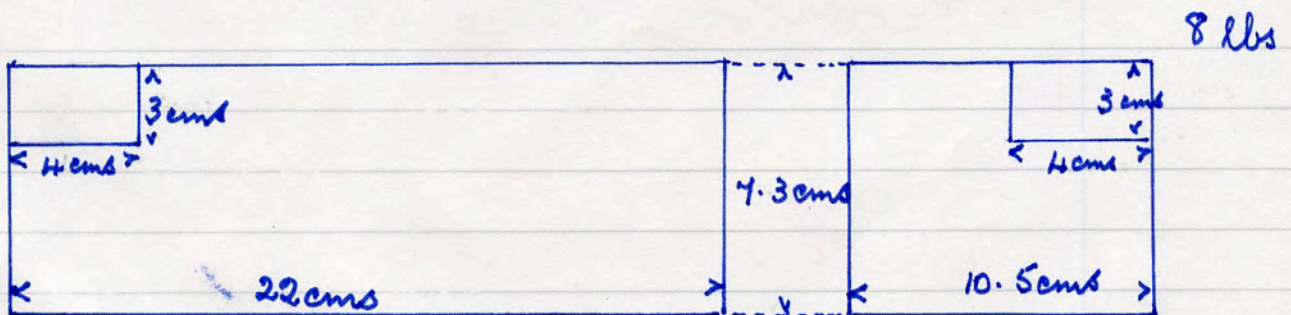

All above - Auction Mori dem. site 6. 8. '90

No name 272 T red. 2 face edges T.C. rest wire run 6 lbs.

4897

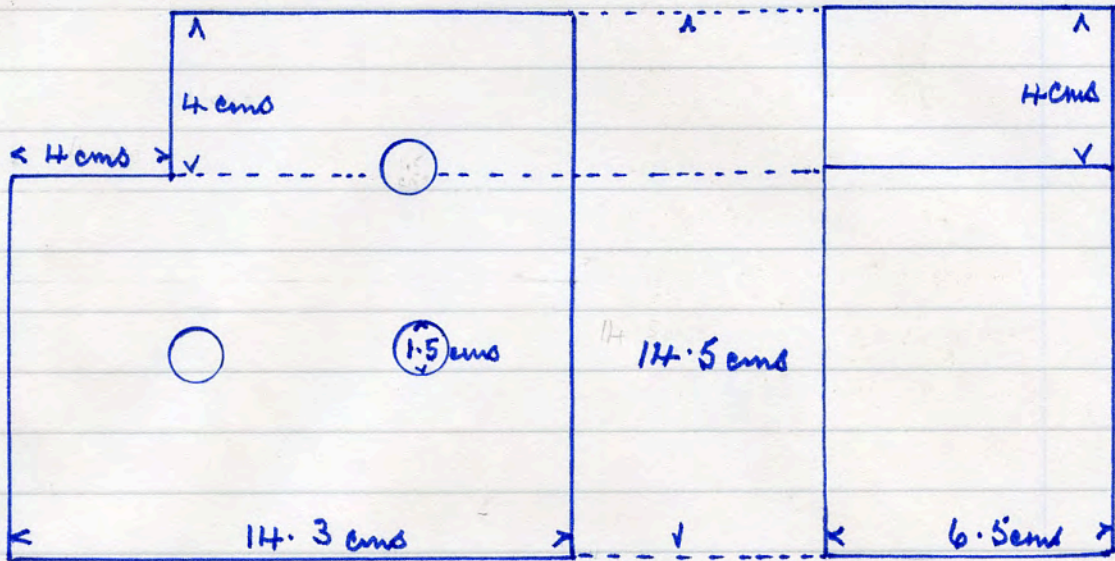

No name 52 P 544 red. 2 edges 1 end smooth T.C. 8 lbs

4898

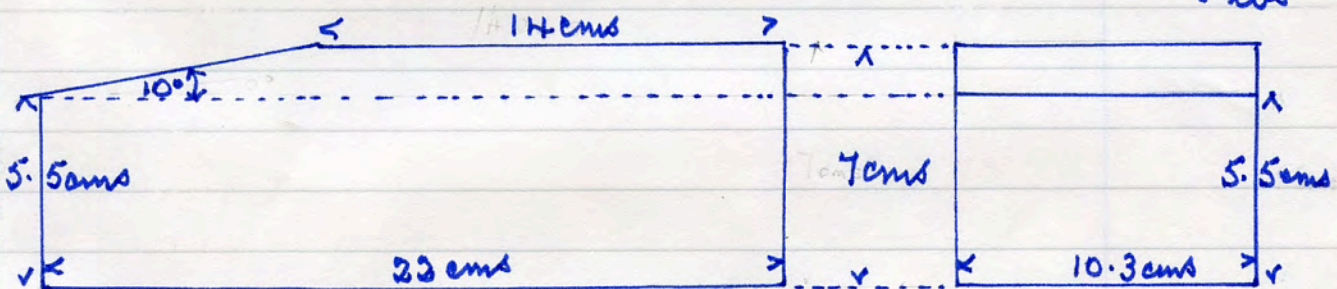

No name 467 VT red. 2 face edges T.C. rest wire run 7 lbs

4899

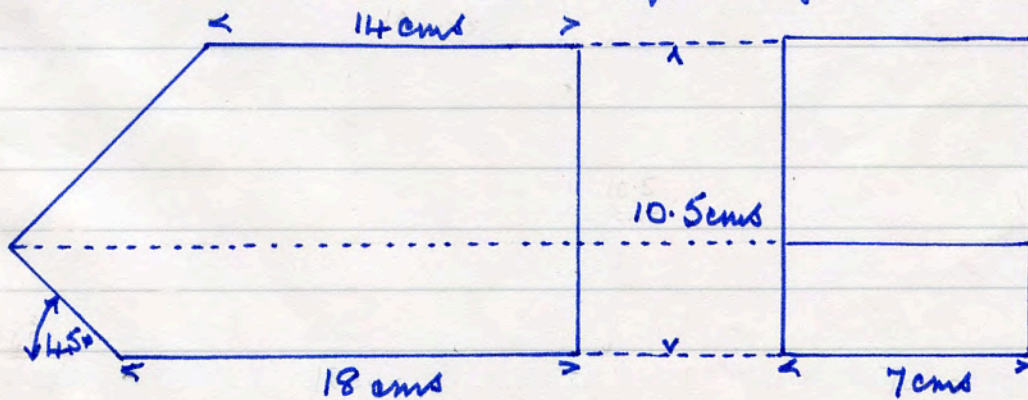

All above - Accton Mori dem. file - 7. 8. 90

No name 210 T1 red all face edges T.C finish

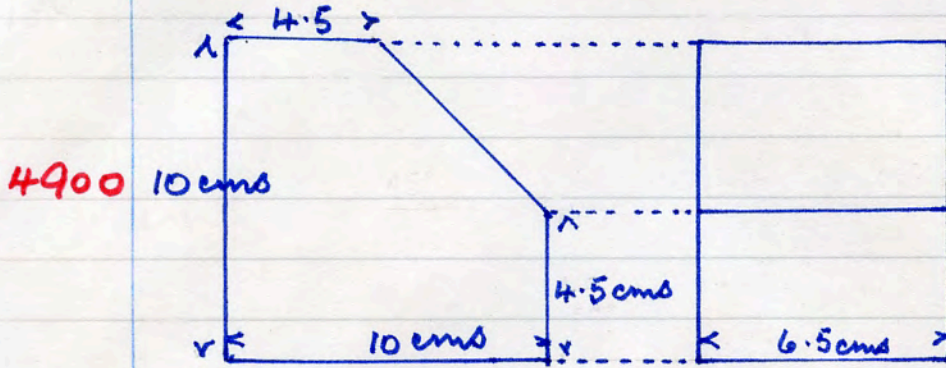

3 lbs

4900

4901

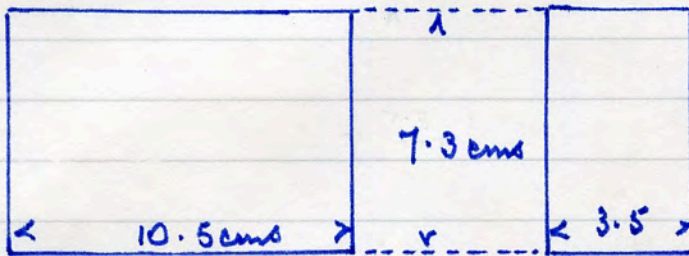

No name 52 P 850 red 1 lb.

1 face side + 2 edges T.C.
rest wire run.

No name 837 V1 red. all face edges 1 face side T.C.

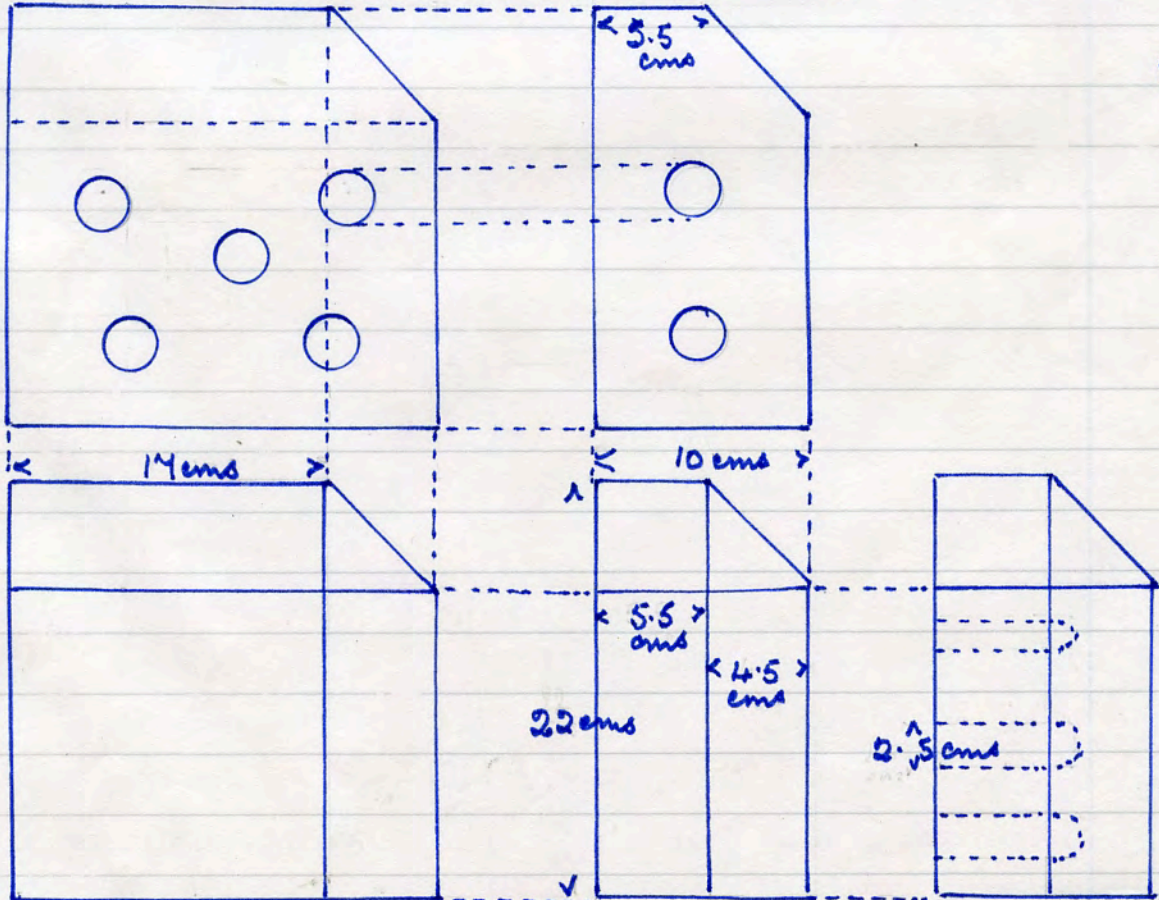

21 lbs.

4902

All above - Acpton Mori dem. site. 7. 8. '90

No name 23171 red jamb lock all edges T.C dressed

4903

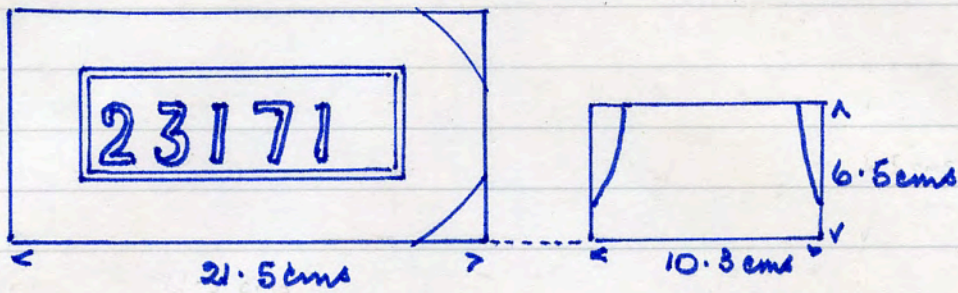

6 lbs.

No name 68 M 27 red 2 faces dressed T.C

4904

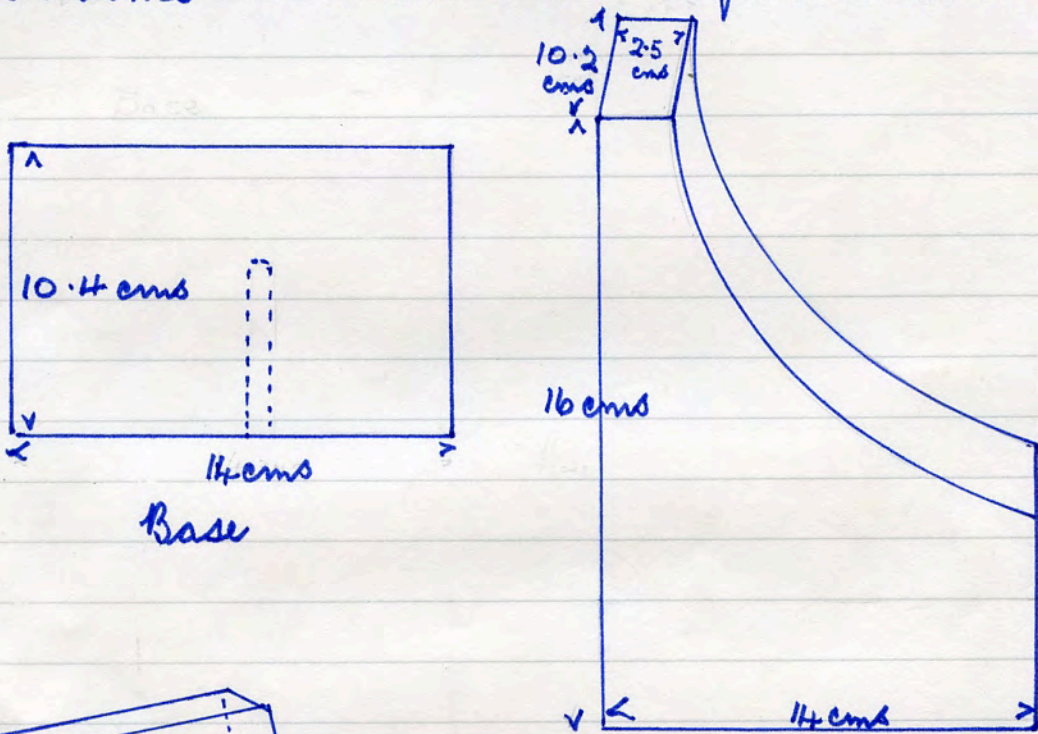

7 lbs

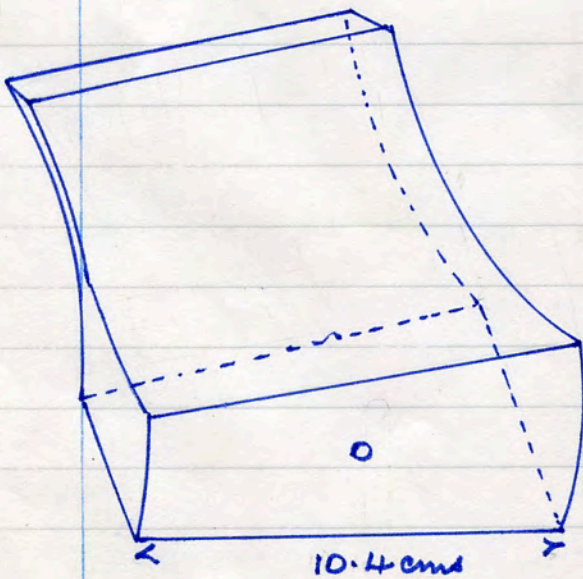

Sketch

Both above - Acpton Mori dem. site 7. 8. '90

No name 208 TB Bowland Brown wire run

4905

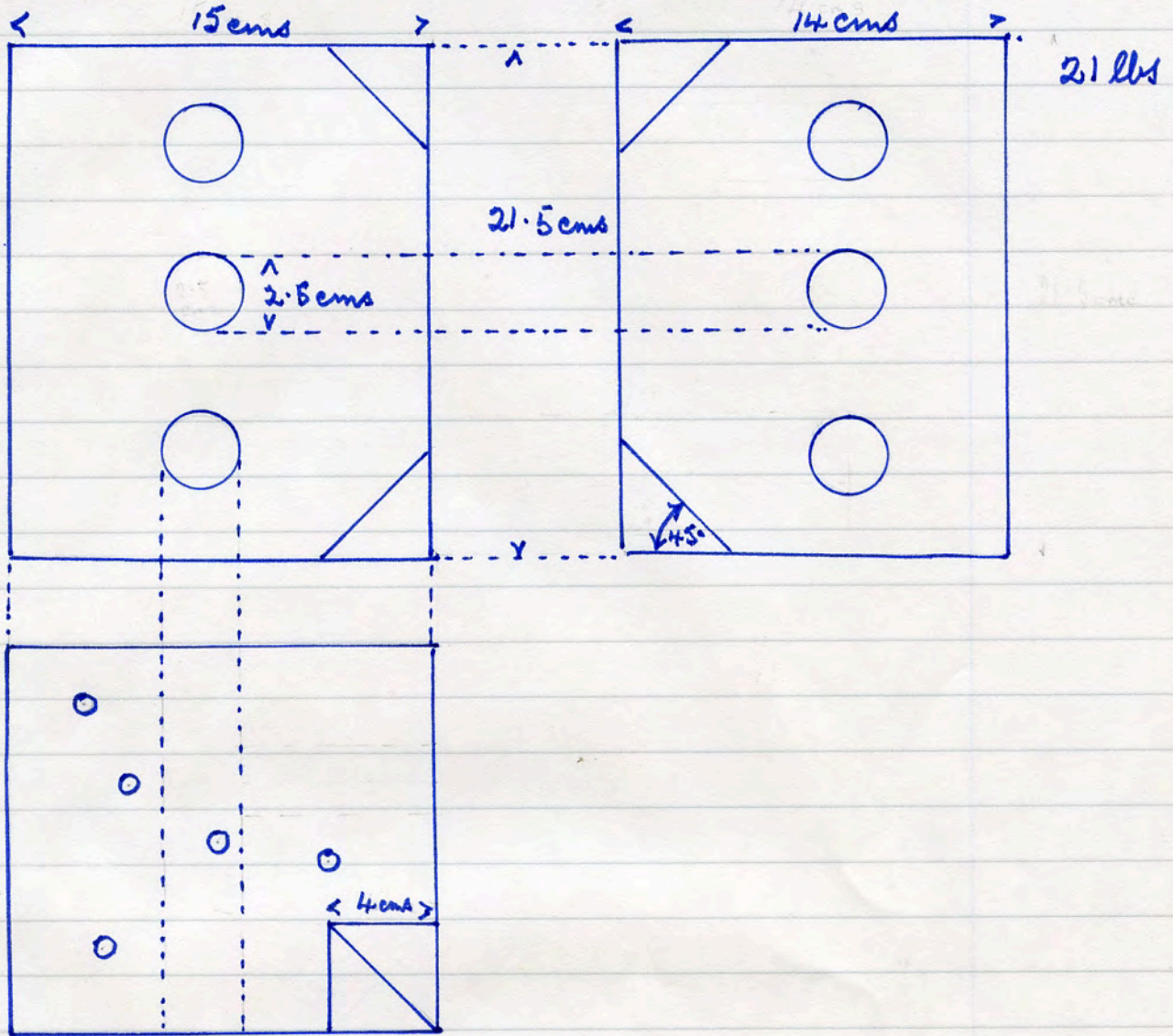

No name 31P 297 red 1 face side T.C.

4906

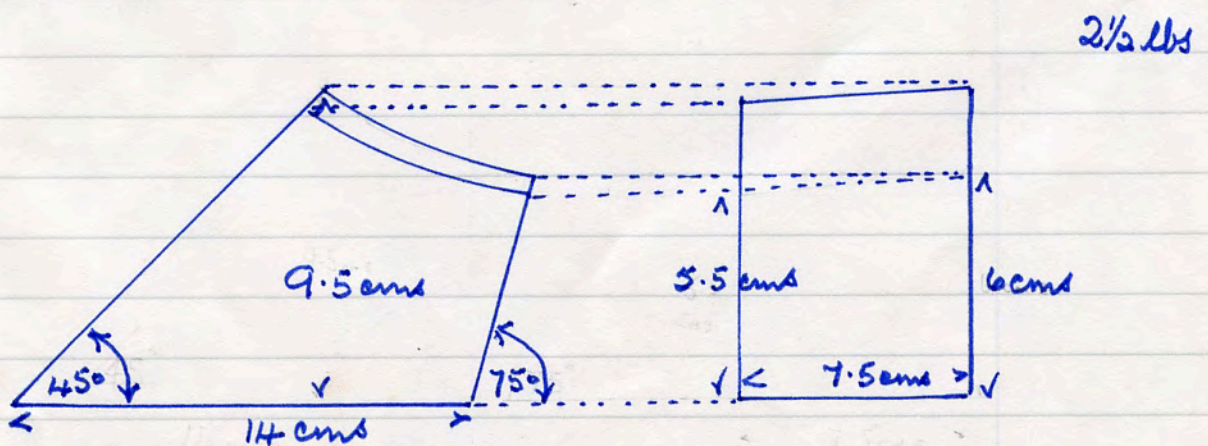

Both above - Gcepton Mori dem. site 7. 8. '90

No name 208 TA Bowland Brown wire run

20 lbs

4907

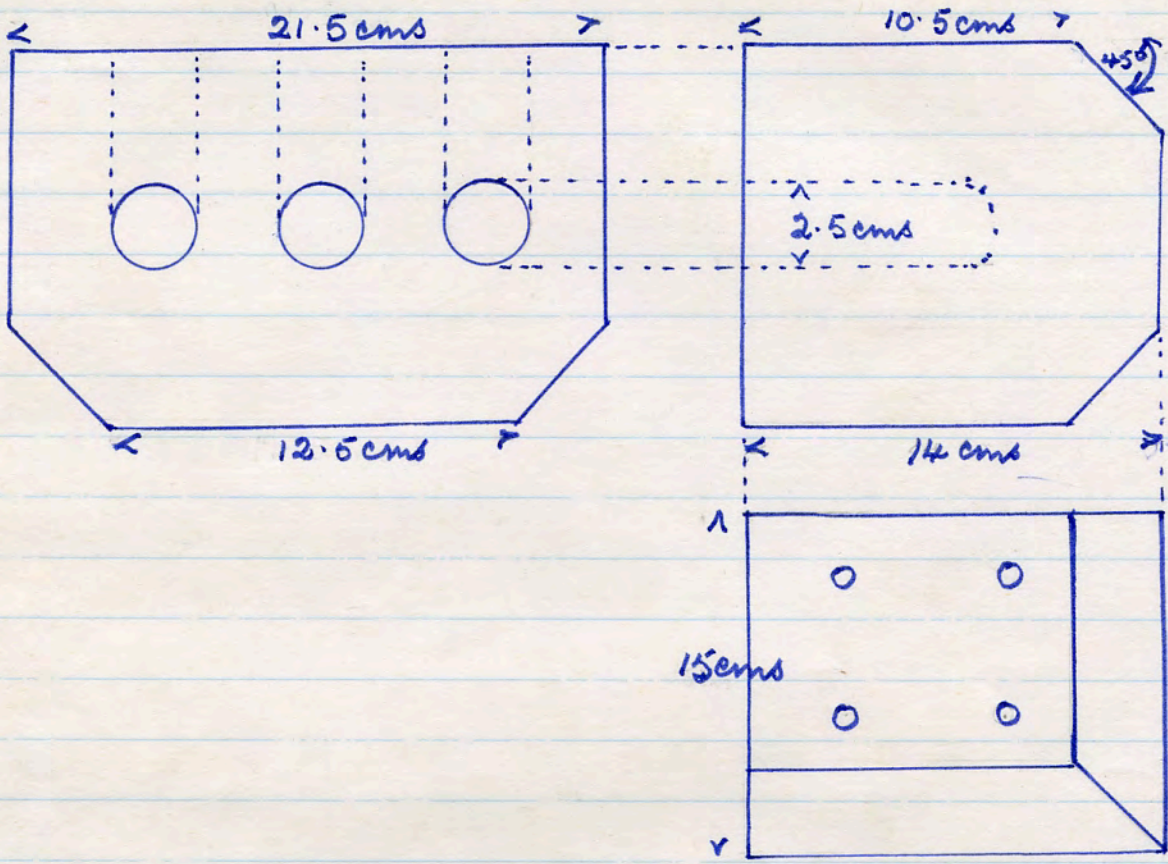

No name 22 P 20 red internal face side T.C.

moulder's mark  9 lbs

4908

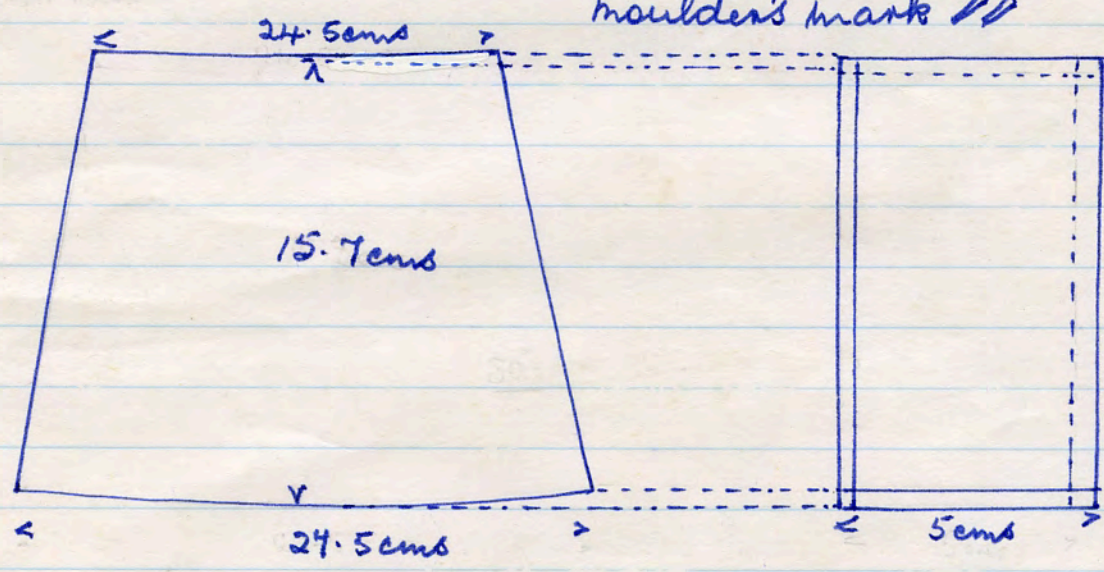

Both above - Acpton Mori dem. site 7. 8. '90

4909

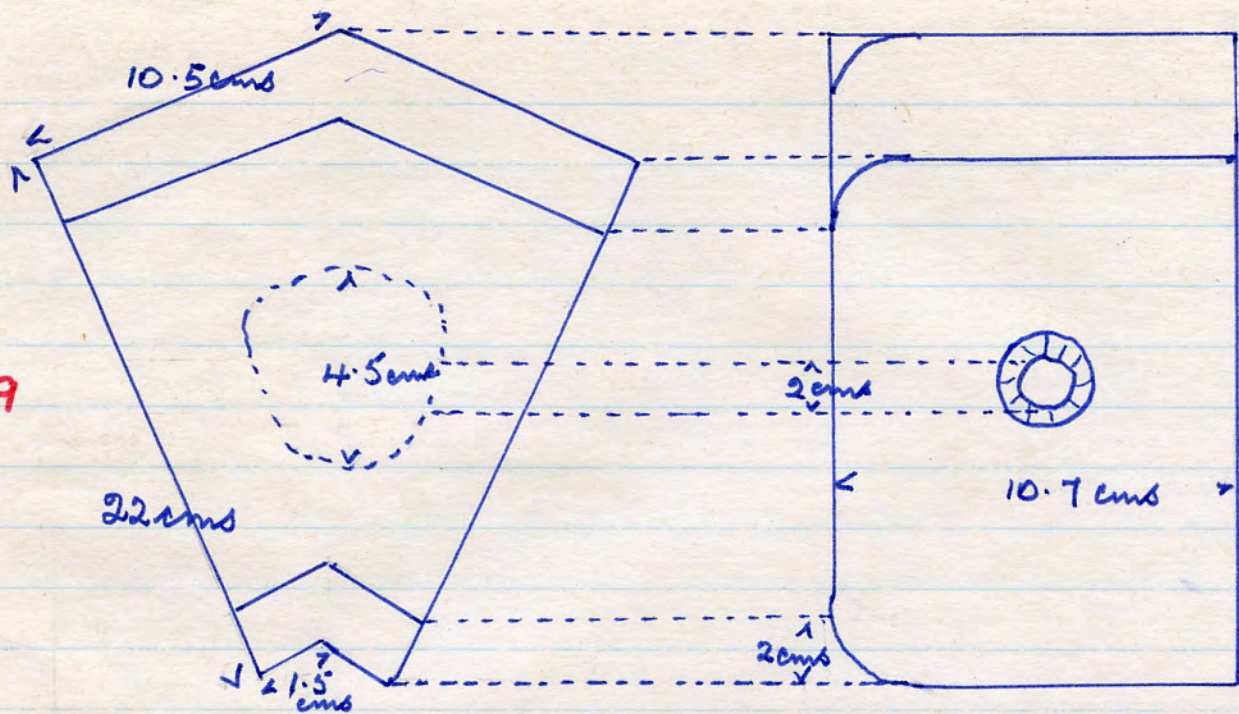

No name. DB 135 red. exterior face T.C.

12 lbs.

4910

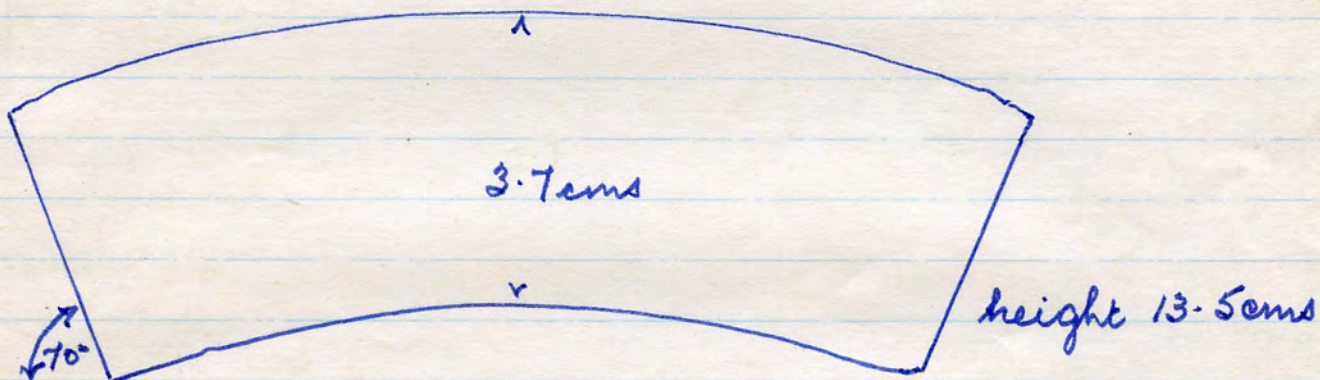

No name 31 P 67 red. internal face dressed T.C.

2 1/2 lbs

Both above - Accrington Manx dem. site 8. 8. '90

4911

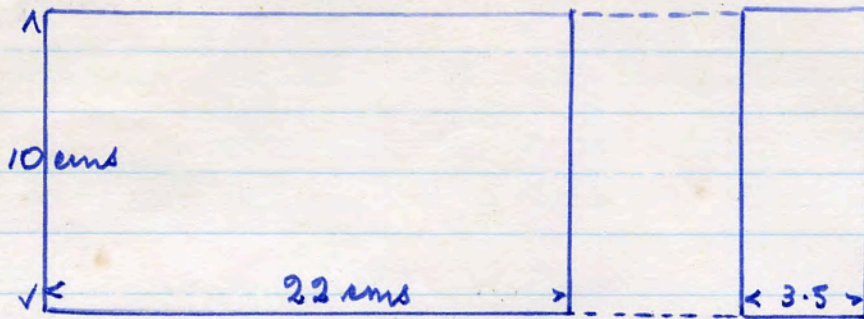

4 lbs

No name. 450-365 red. all 4 edges dressed T.C.

4912

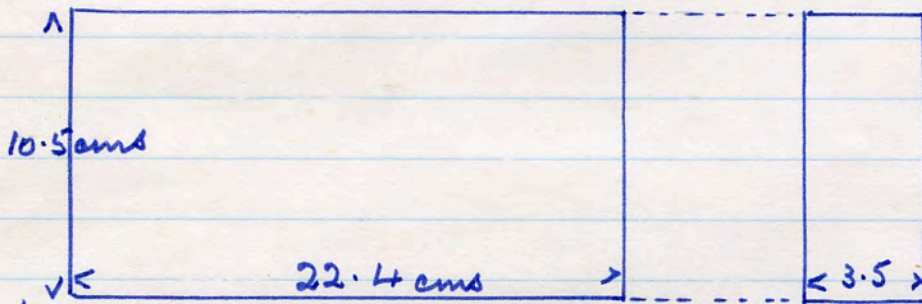

4 1/2 lbs

No name 14 CZ red. all 4 edges dressed T.C

4913

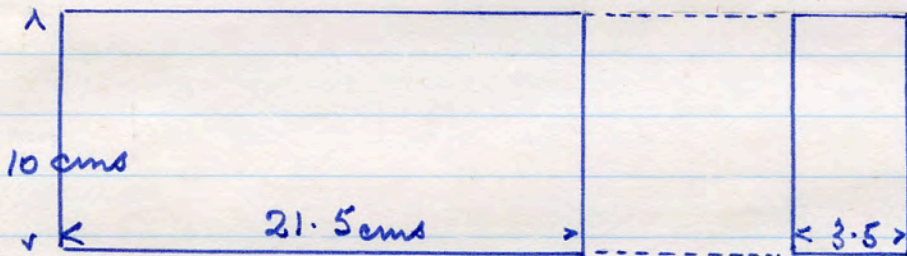

3 1/2 lbs

No name 450 B red 4 edges + 1 face side T.C

4914

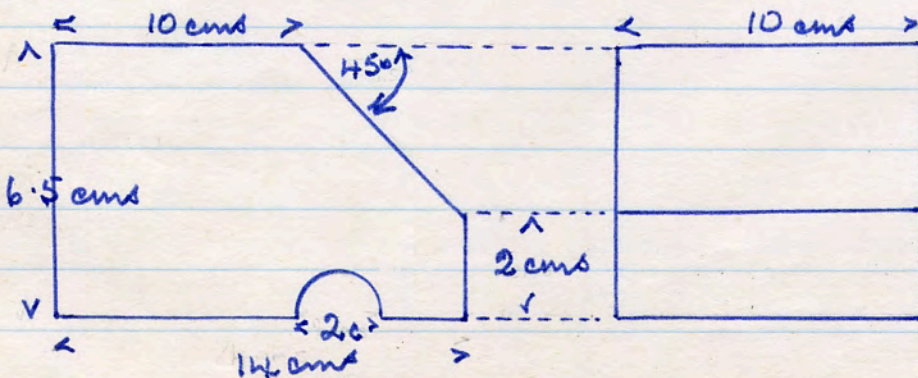

No name 224 T 2R red all dressed T.C.

4 1/2 lbs

All above - Acclton Nori dem. site 8. 8. '90

No name 99 N 45 red pitch end T.C. rest combed
7 lbs

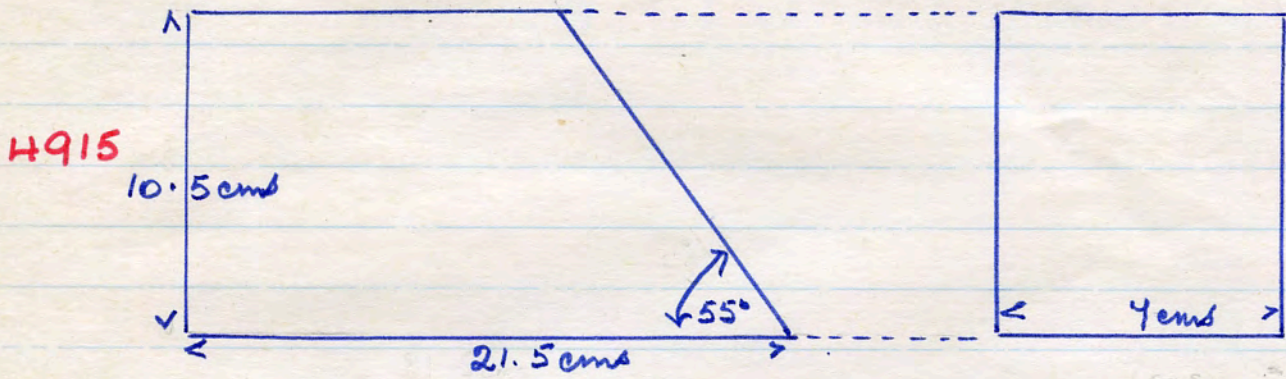

No name 90 F 159 red. 2 sides T.C. rest combed

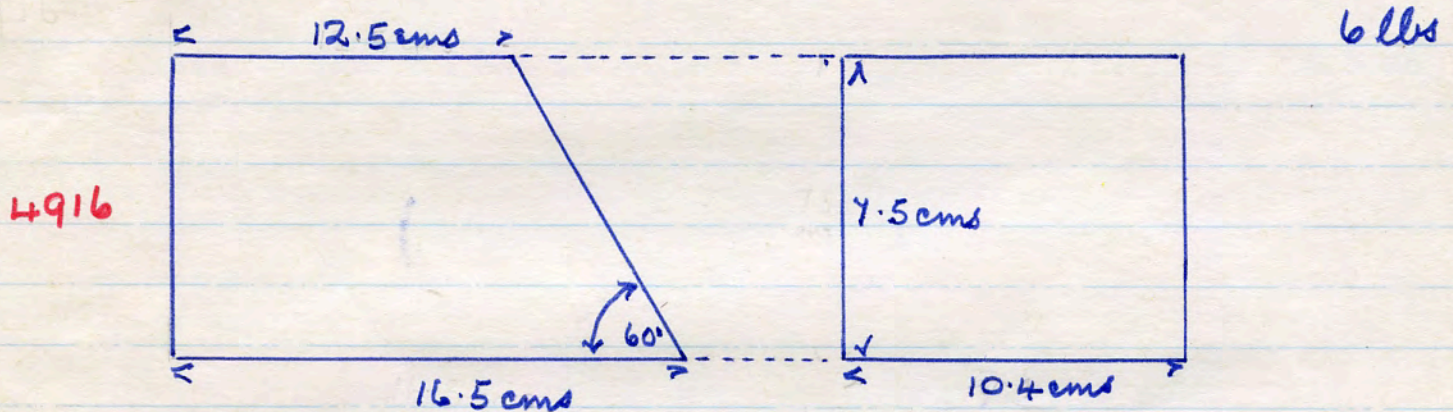

No name 31 P 61 red 2 sides T.C. rest combed

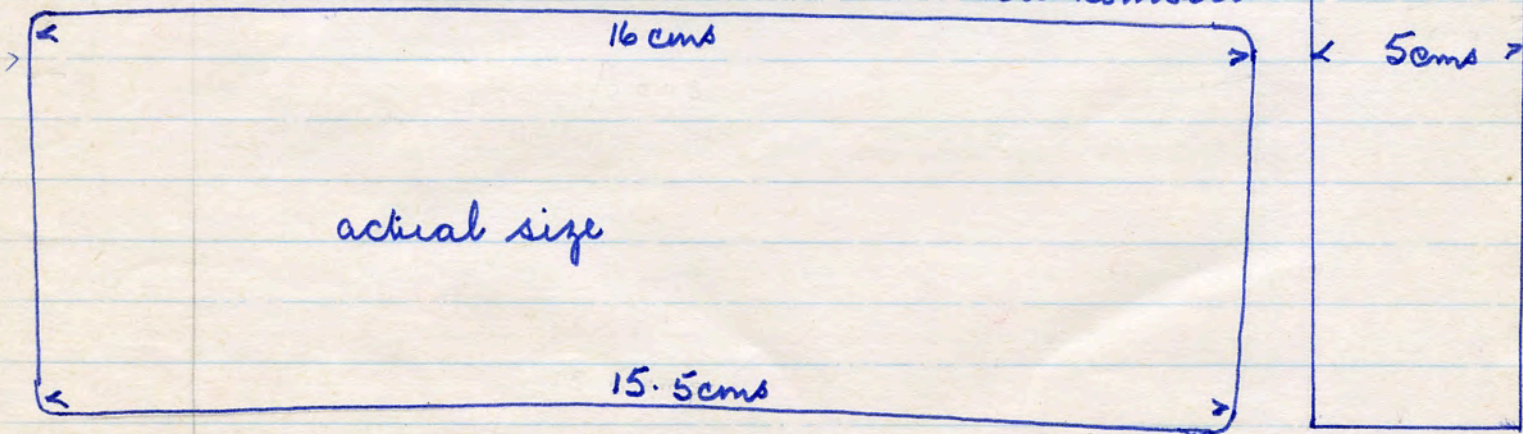

4917 all corners pencil mould

All above. Acpton Maxi dem. site 8. 8. '90

4918. No name 971 WB red chamfered return

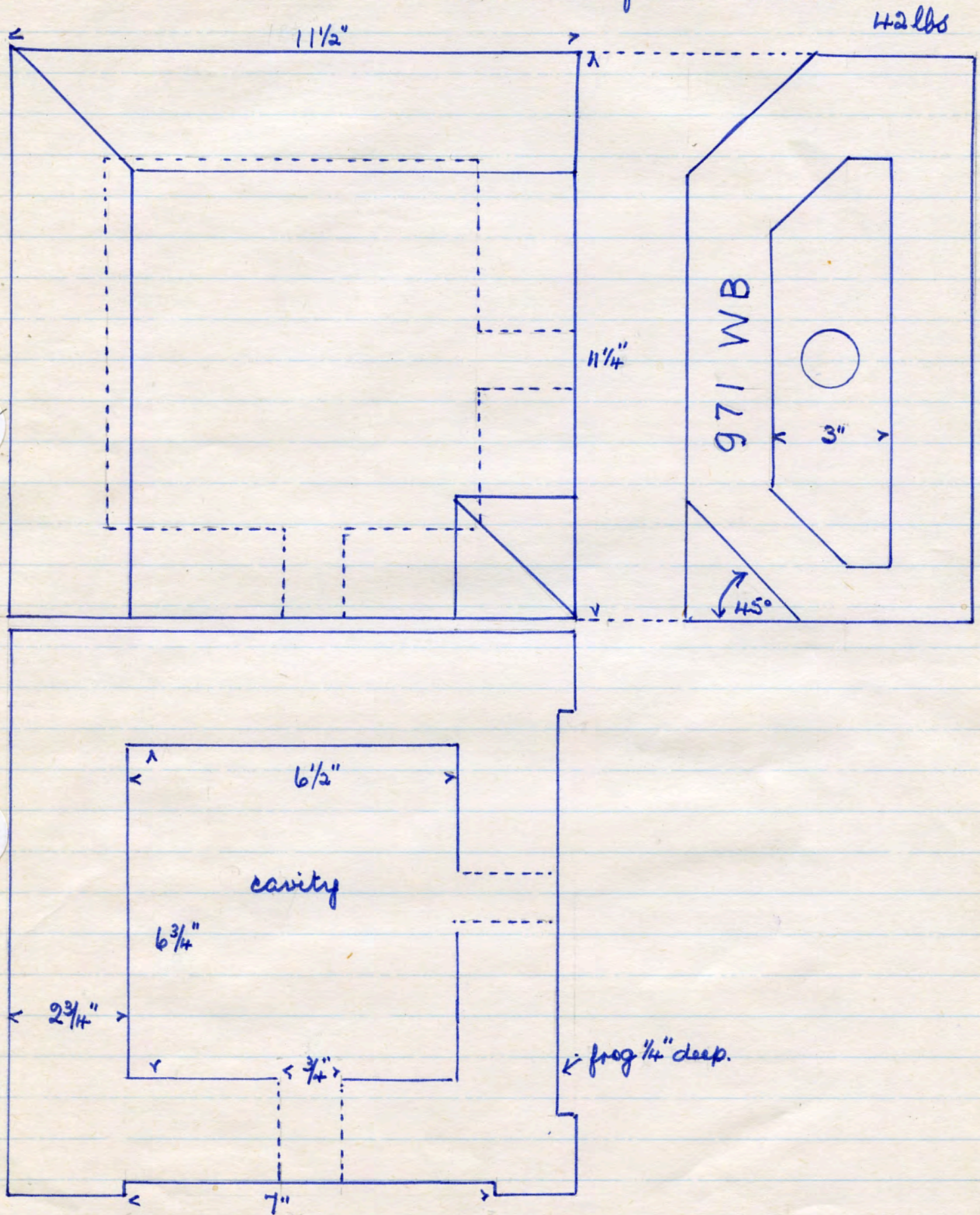

Acetone Mori dem. site

8. 8. '90

No name PYL all edges & sides + moulded quadrant red T.C.

4919

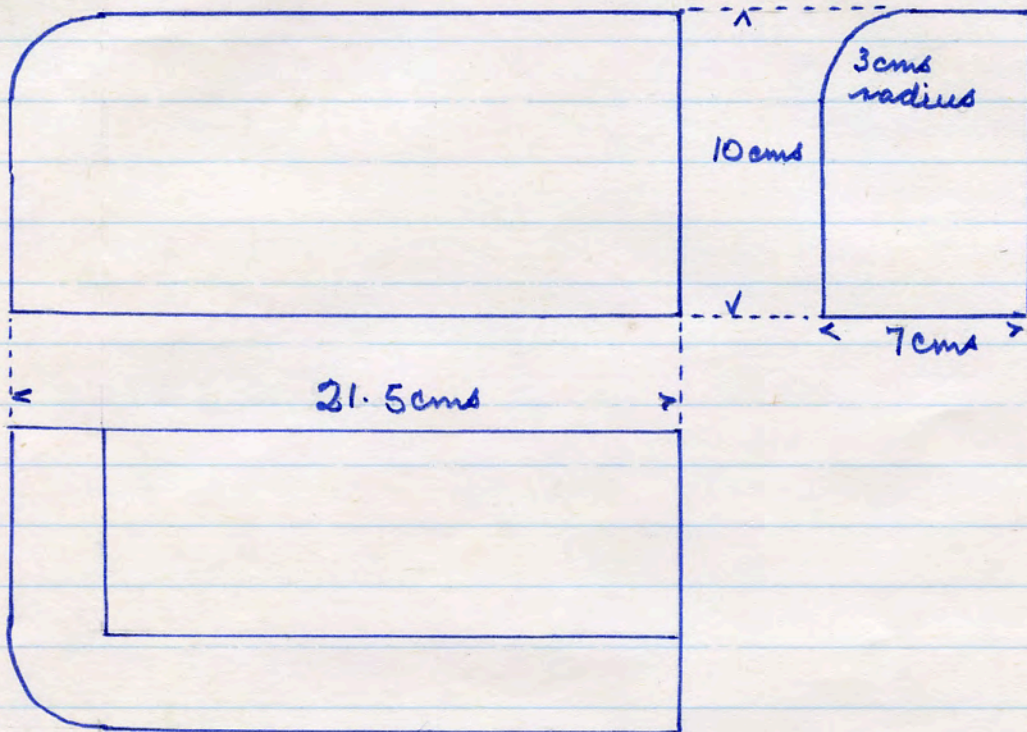

8 lbs

No name 56 H 37 red wire mesh 1 face edge, 1 face side T.C. 8 1/2 lbs

4920

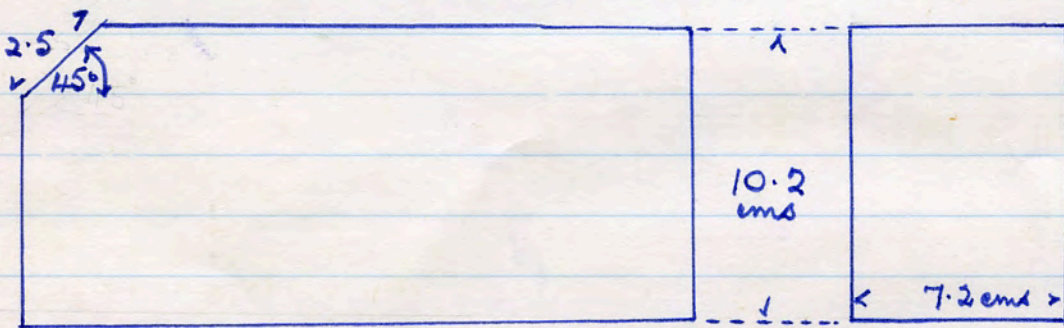

T.C. 8 1/2 lbs

No name 57 H 40 red all face sides T.C.

4921

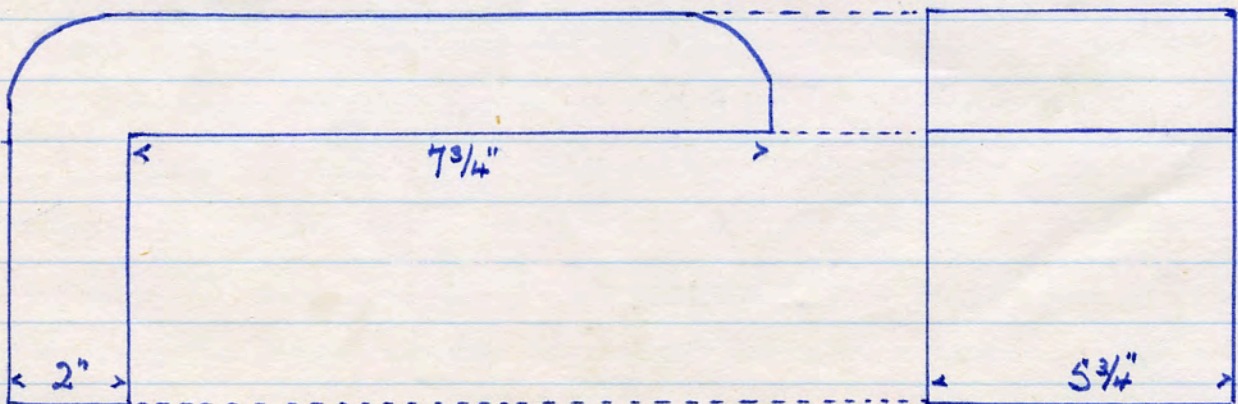

12 1/2 lbs
mm. V1

All above - Acceptor Mori dem. site 9. 8. 90

No name 91 K 90 red 2 face edges dressed T.C

4922

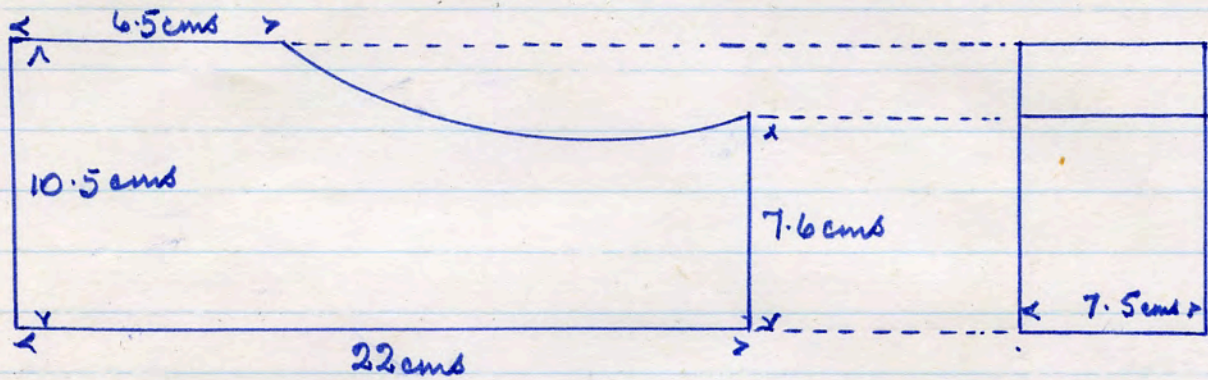

8 1/2 lbs

NORI ACCRINGTON red letters stamped. 1/2 bullnose

10 lbs

4923

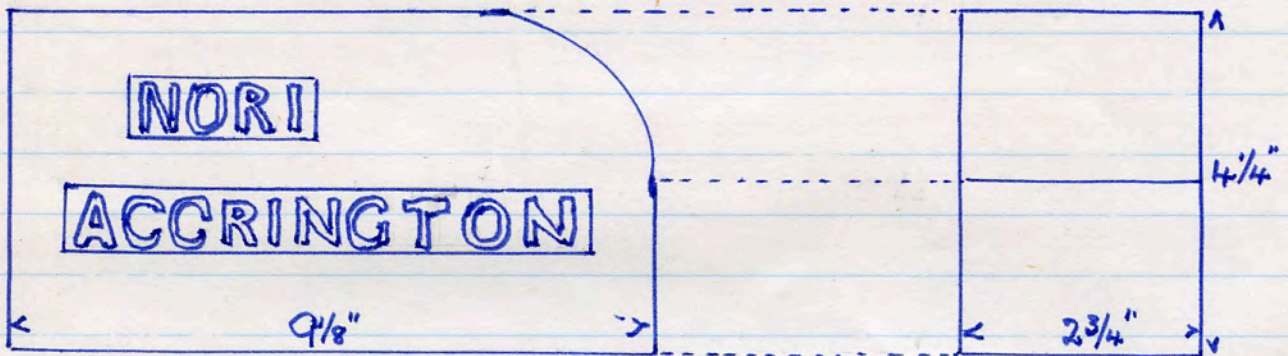

No name 2512 LB red blk with face edge end + splay

8 lbs
left

4924

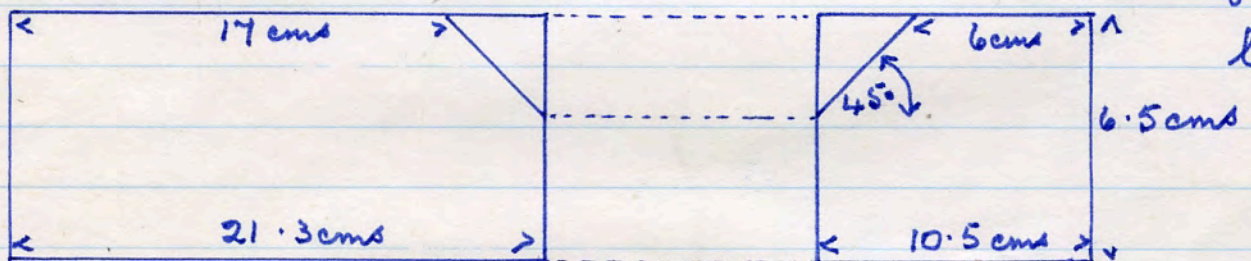

No name 2512 RB red - pair to above.

right
8 lbs

4925

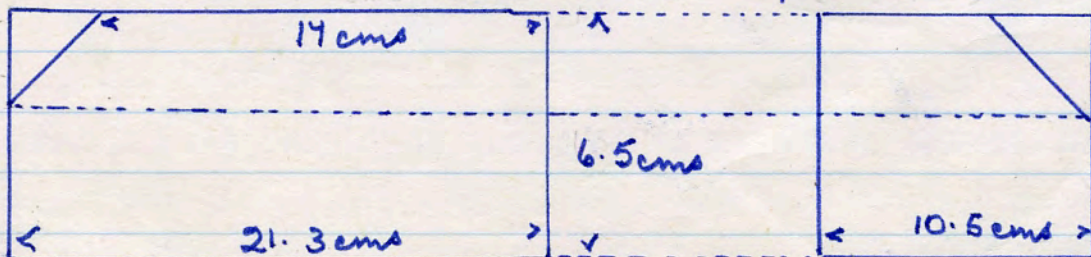

All above - Accpton Mori dem. site 9. 8. '90

No name 239 2L red T.C all round quadrant return

4926

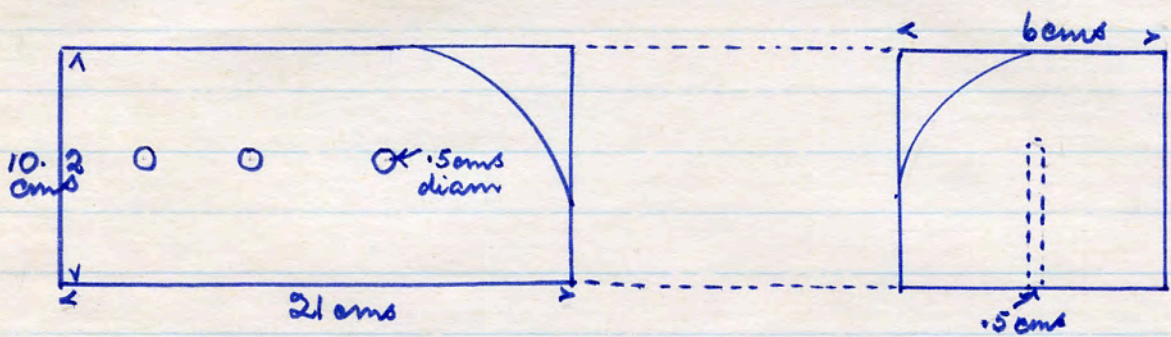

left
8 lbs

No name 239 2R similar specification to above

4927

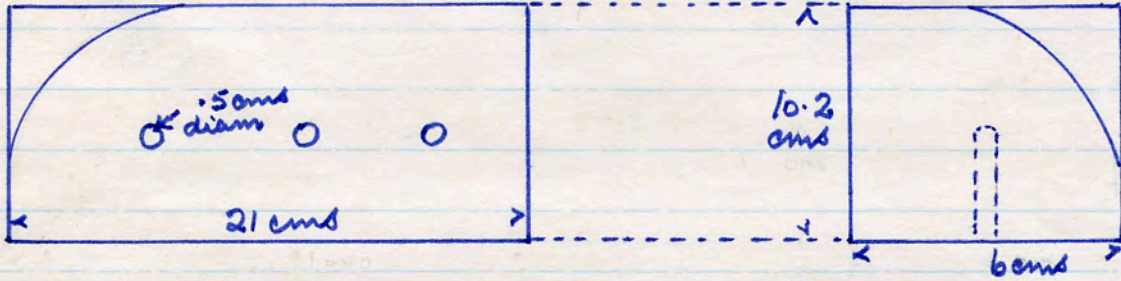

right
8 lbs

No name 238 1L red 1 face edge + 1 end T.C.

4928

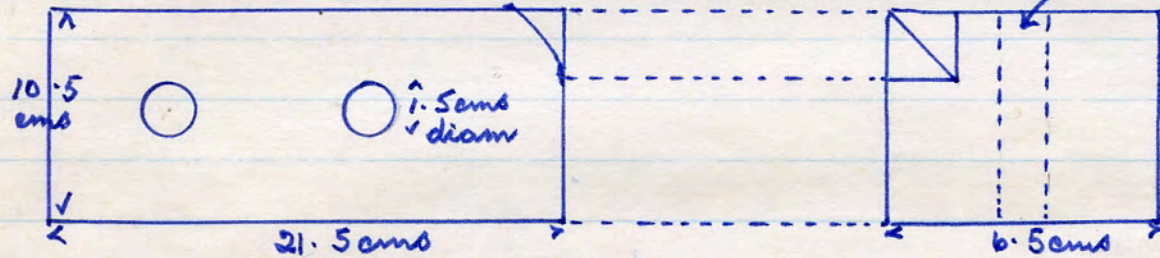

left
8 lbs

No name 238 1R red 1 face edge 1 face end T.C.

4929

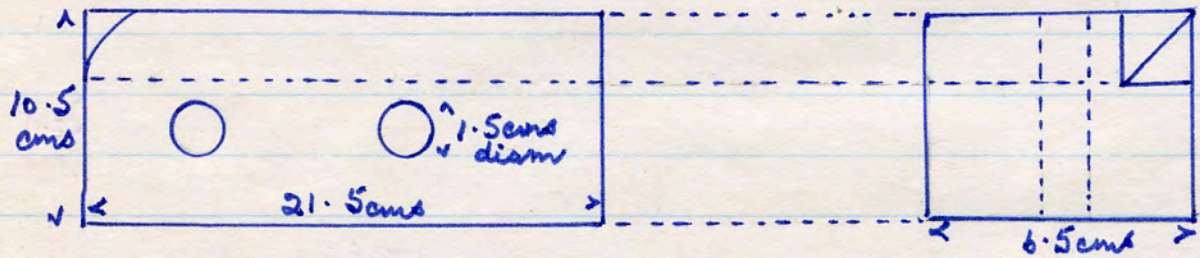

right
8 lbs.

All above - Acceptor Mori dem. site 9. 8. '90

4930

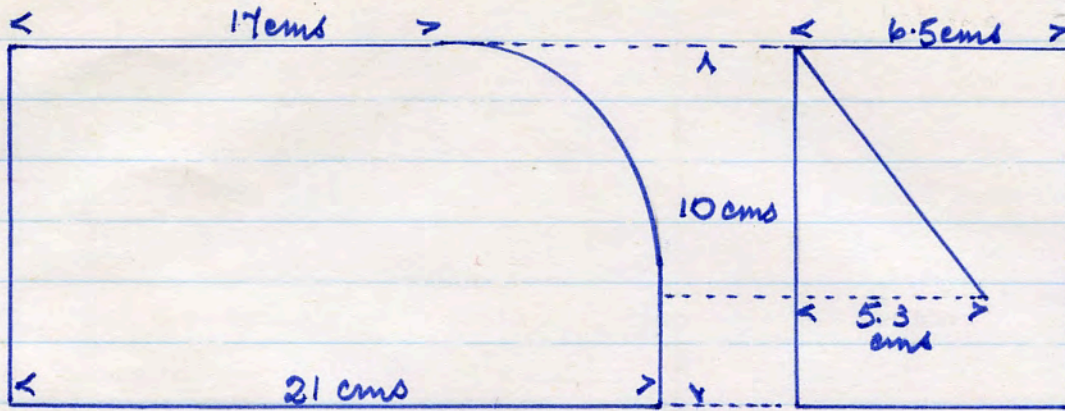

8 lbs

left

No name 238 2L red wire run. face edge & face end T.C.

4931

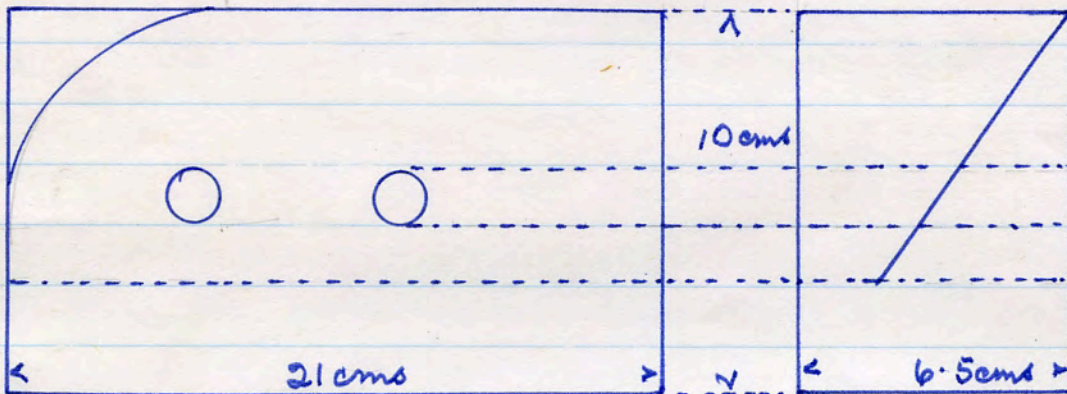

8 lbs

right

No name 238 2R red. wire run face edge & face end. T.C

4932

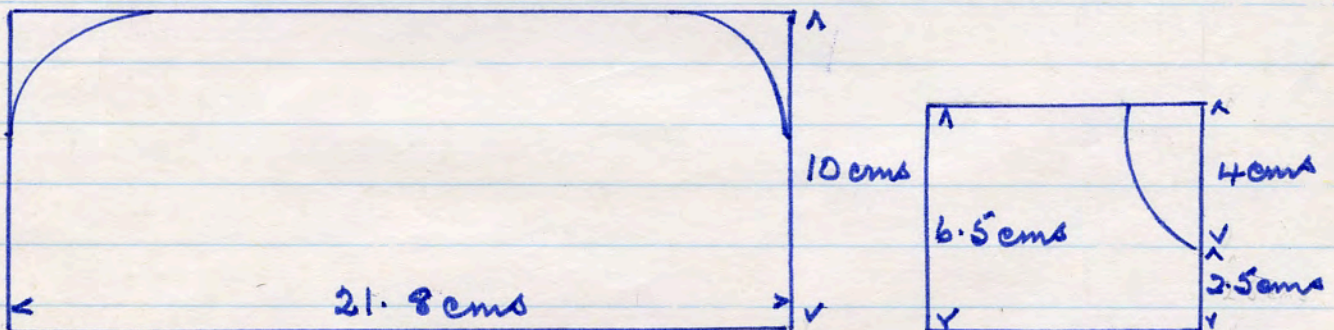

No name 2341 red. T.C all round

All above - Auction Mori dem. site 9. 8. '90

No name 236 IR red. face side, 1 face edge + end T.C.
right
8 lbs

4933

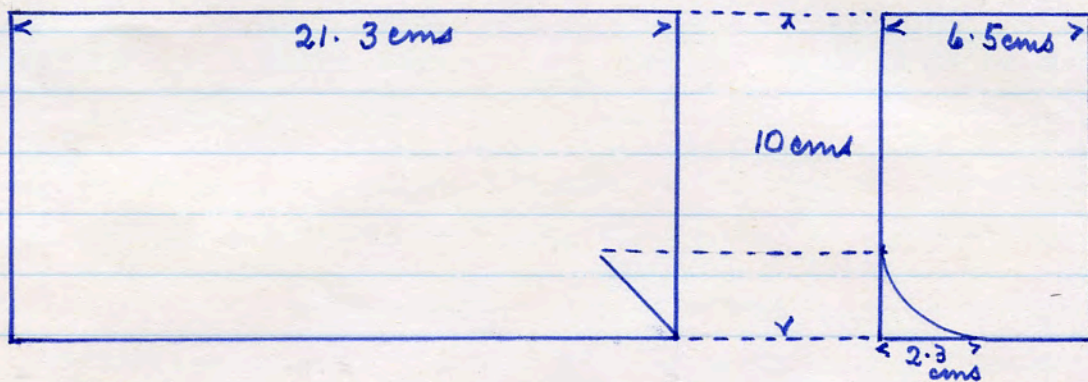

No name 236 IL red. face side, 1 face edge + end T.C.
left
8 lbs

4934

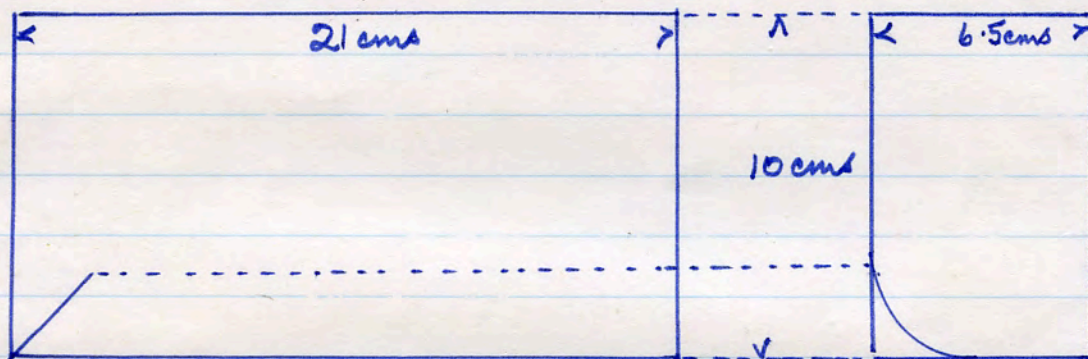

No name. 233 IR red. face side + face end T.C.

4935

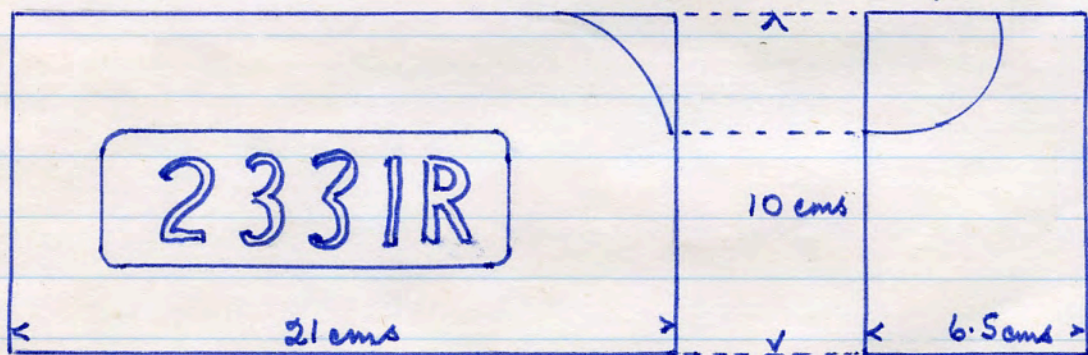

slight indent each side acting as frog. members scribed

all above - Acpton Mori dem. site. 9. 8. '90

No name 233 2L red. 1 face end 1 face side T.C.

4936

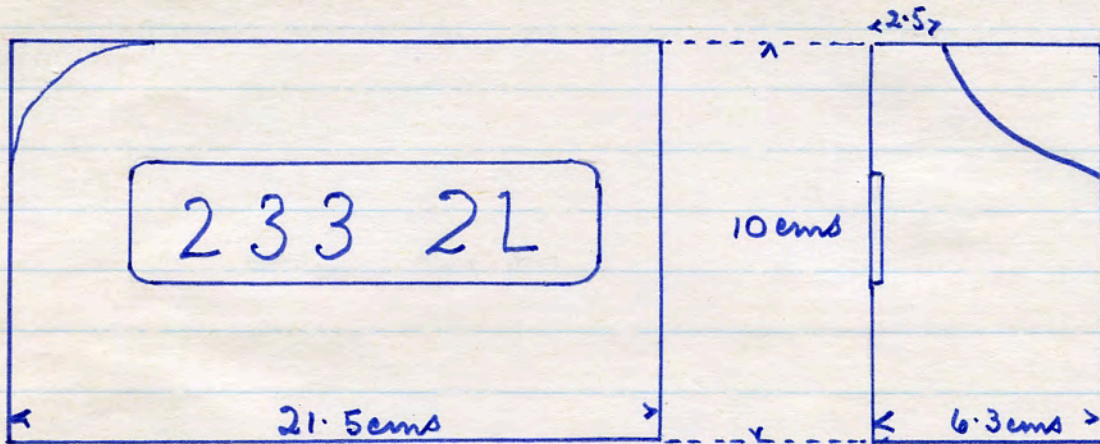

6 lbs

No name 23172 red 1 face end 2 face sides T.C.

4937

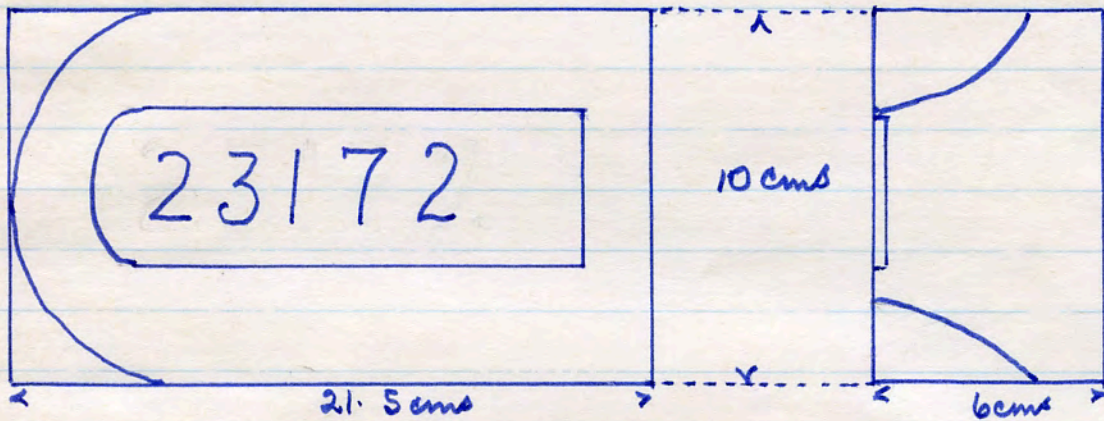

6 1/2 lbs

No name 998 V6 red. 1 face side, end & edge T.C.

4938

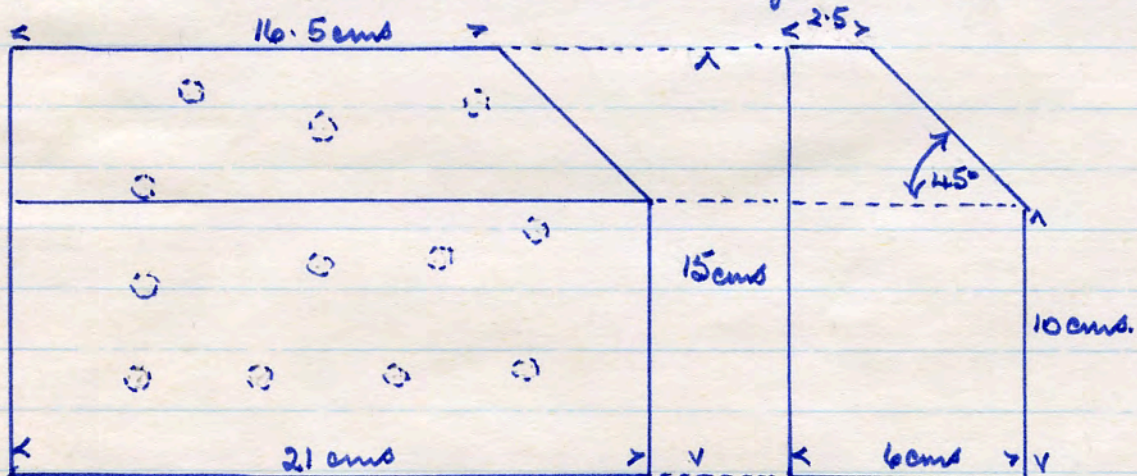

8 1/2 lbs

All above - Acpton Mori dem. site 10. 8. '90

No name 94 J 4 red.

circular internal T.C
external scratched
moulder's mark JI.
20 lbs

4939

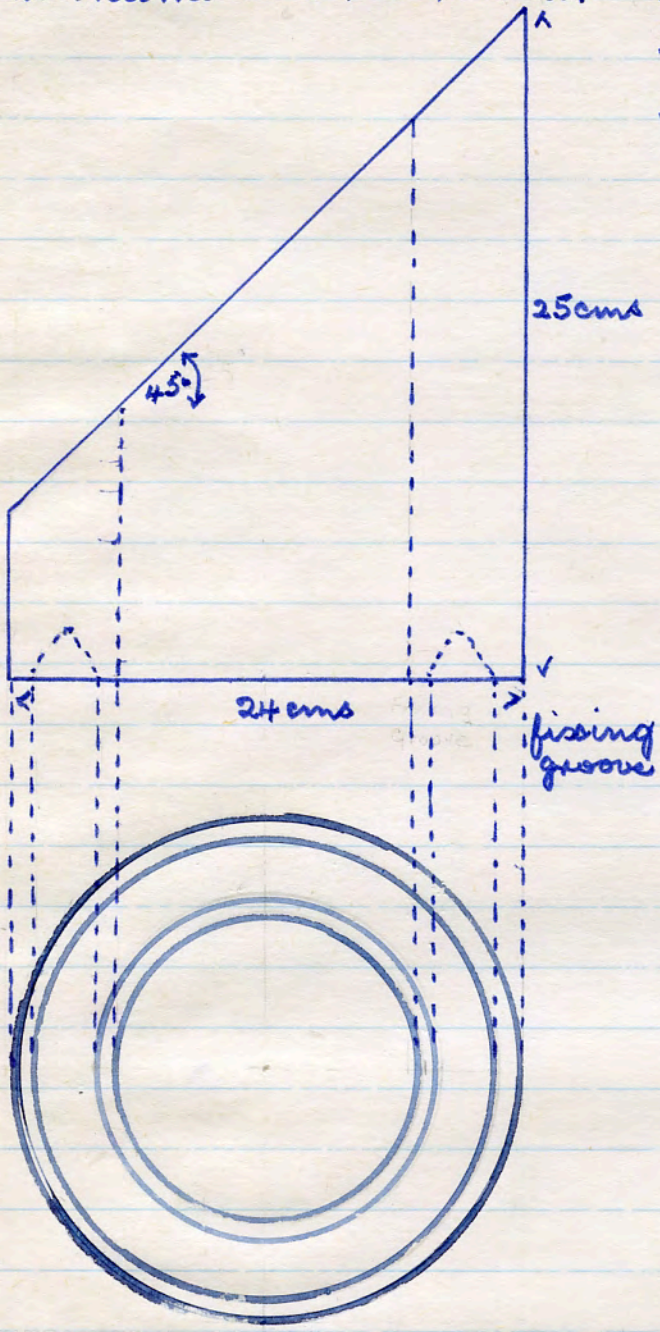

4940

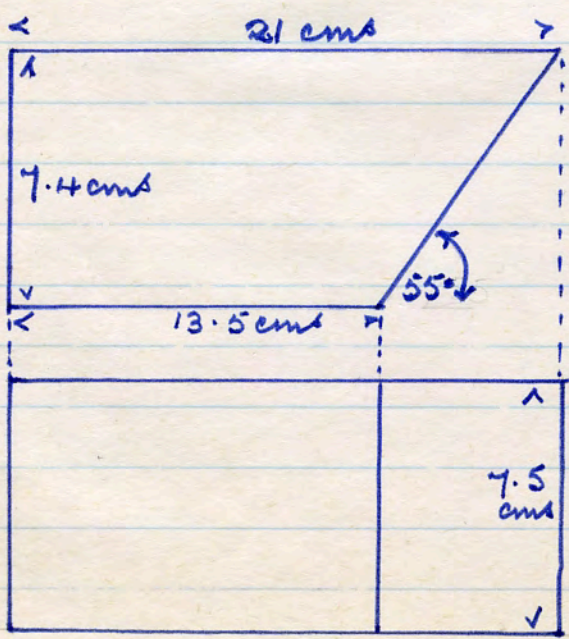

No name 56 H 36 red
pitch 4 | face edge T.C.
8 lbs.

Both above - Accpton Mori dem. site
10. 8. '90

No name 90 F1 91 red 1 face edge & circular sweep dressed with T.C.

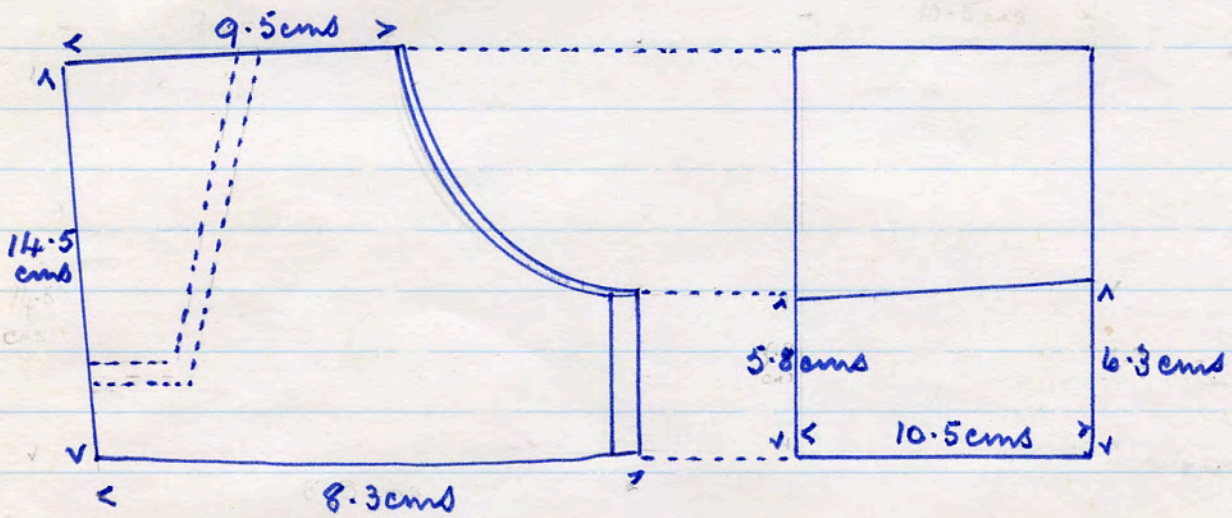

11 lbs.

4941

14.5 cms

9.5 cms

5.8 cms

6.3 cms

10.5 cms

8.3 cms

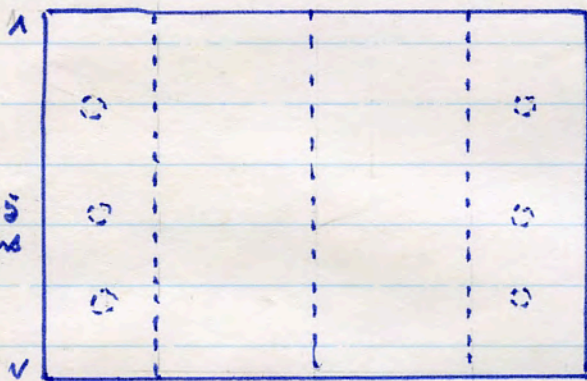

No name 314 TR red.

exterior faces only dressed with T.C.

4942

21.5 cms

17 lbs.

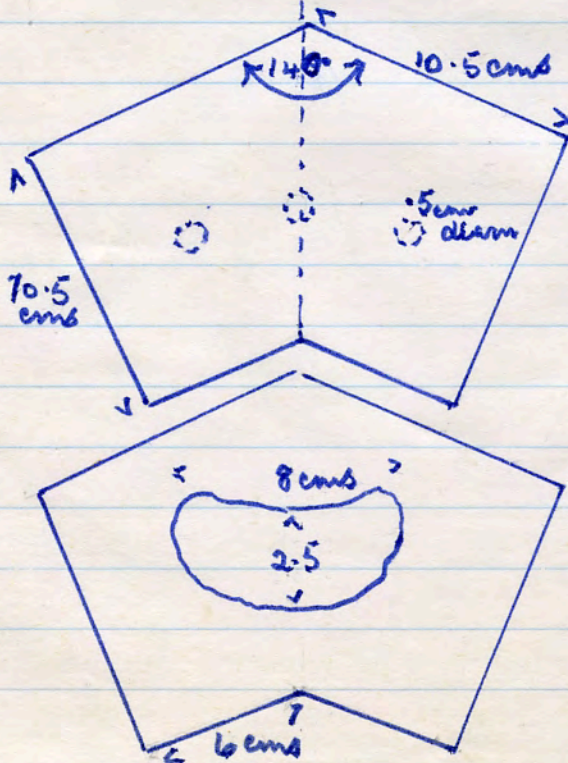

Both above -
hception Mori dem. site

10. 8. '90

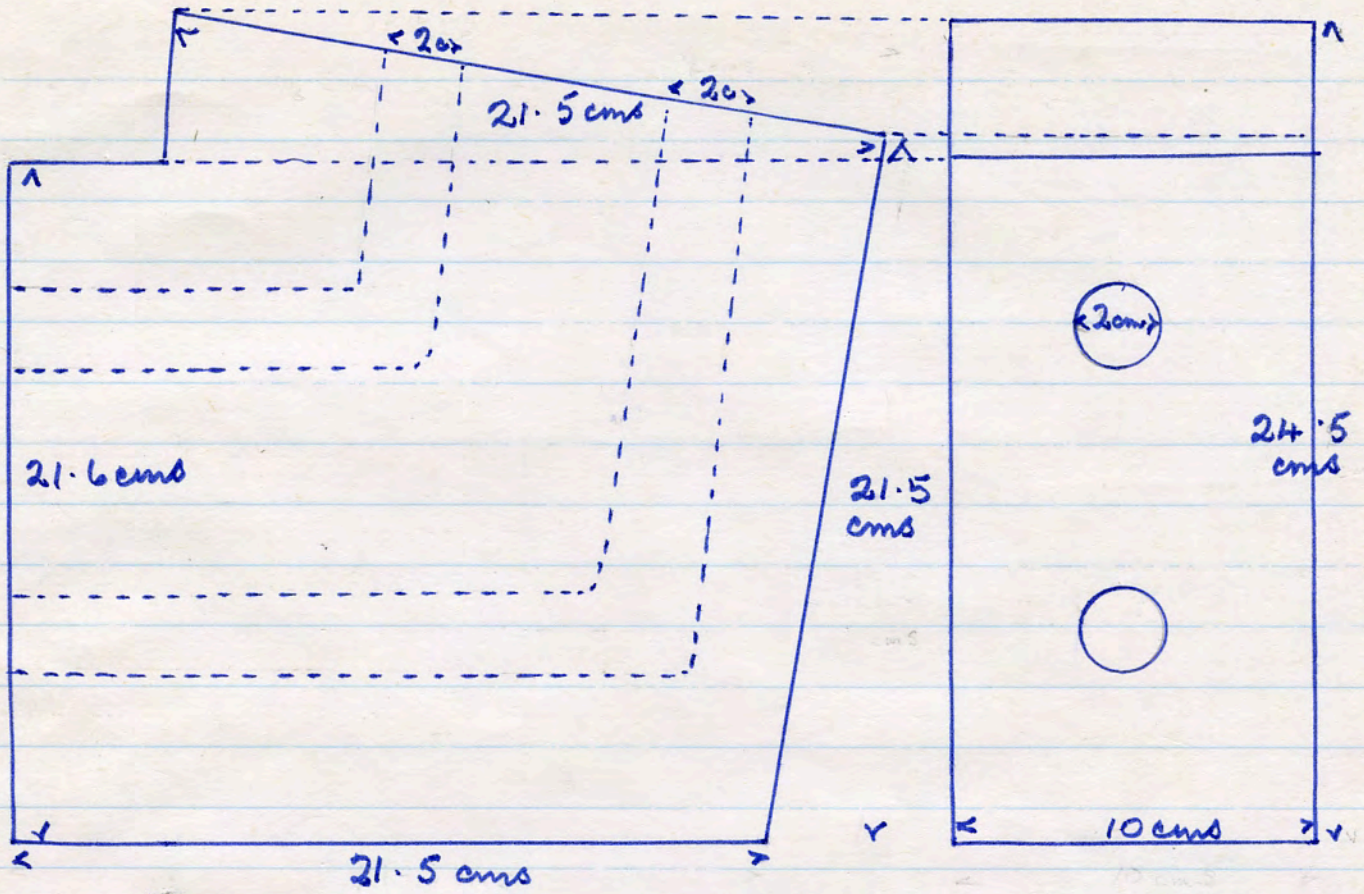

4943

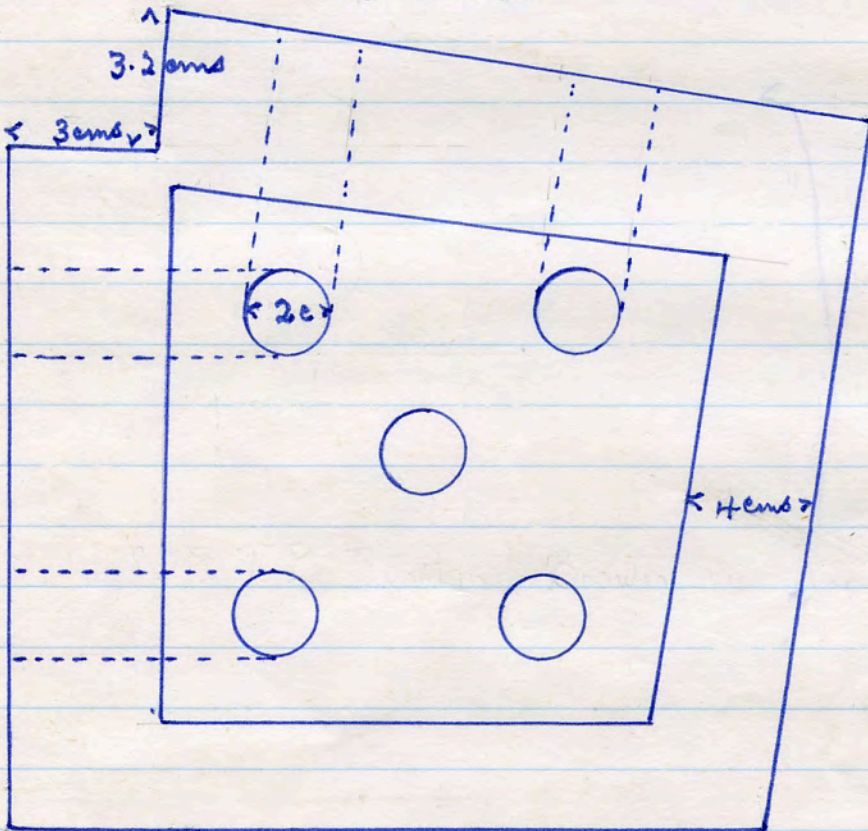

26 1/2 lbs.

No name 159 TA red. 1 face side, 1 face edge T.C.

Acfton Mari dem. site 10. 8. '90

No name 485 V red face edges dressed T.C. m.s.m. HB

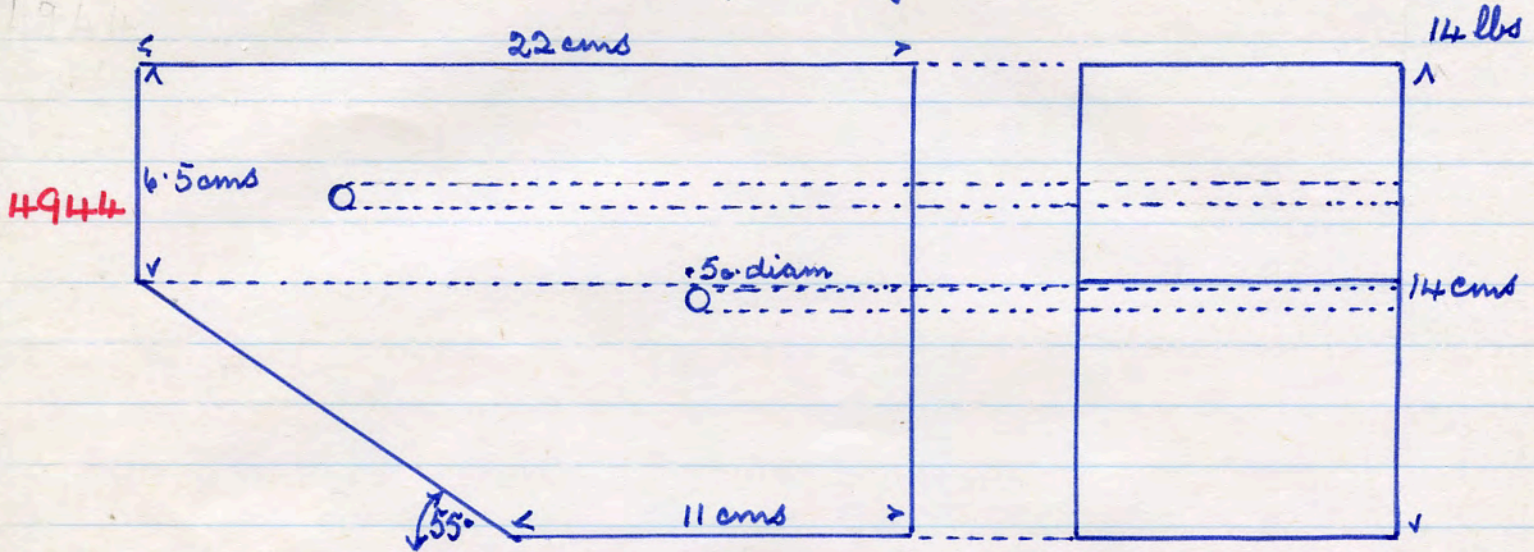

No name 271 T 18 red 2 face edges 1 face side dressed T.C. 14 lbs

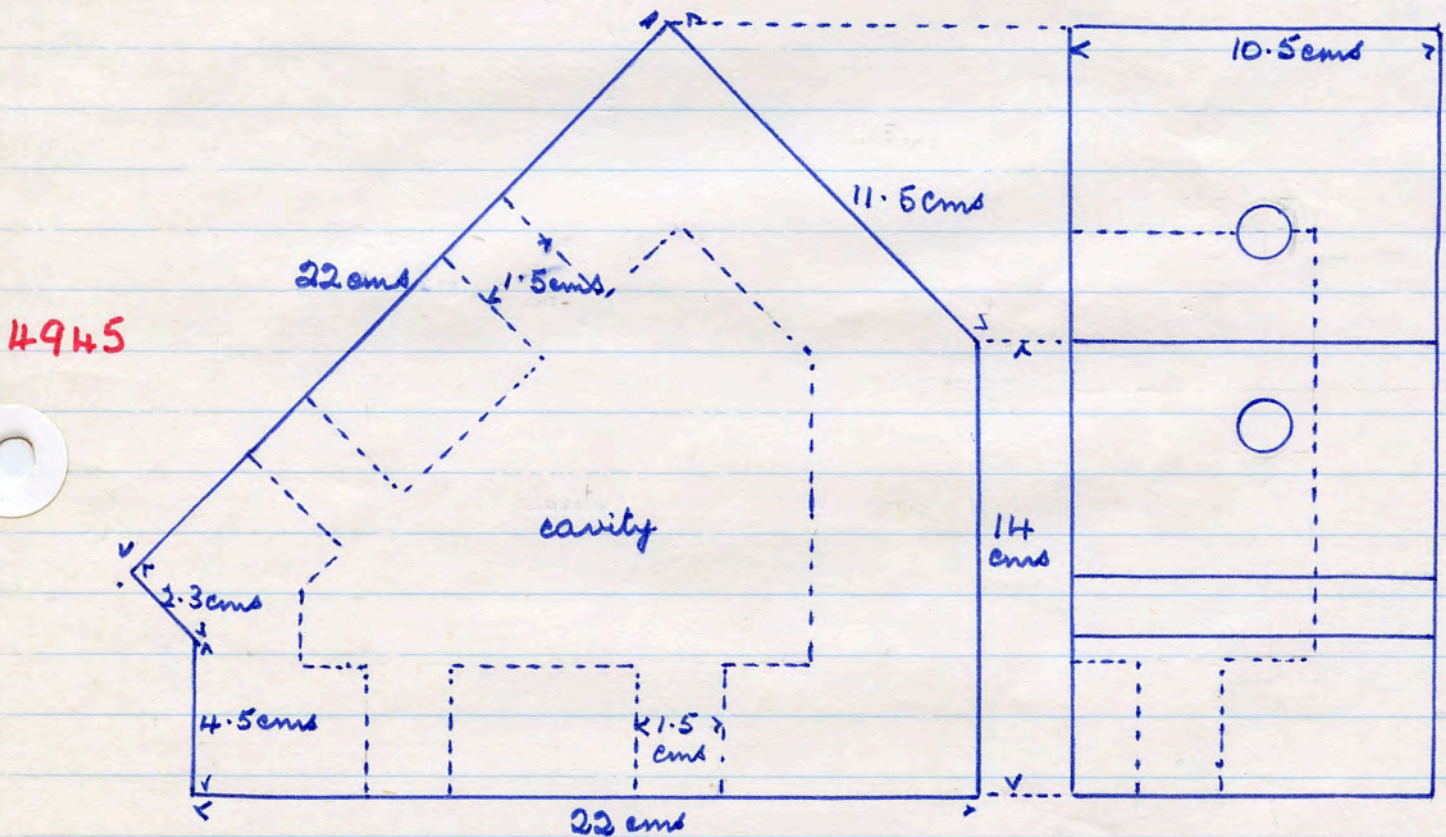

Both above - Acc'ton Mori dem. site 11. 8. '90

No name AW red tile T.C. shale, not dressed 10 lbs

4946

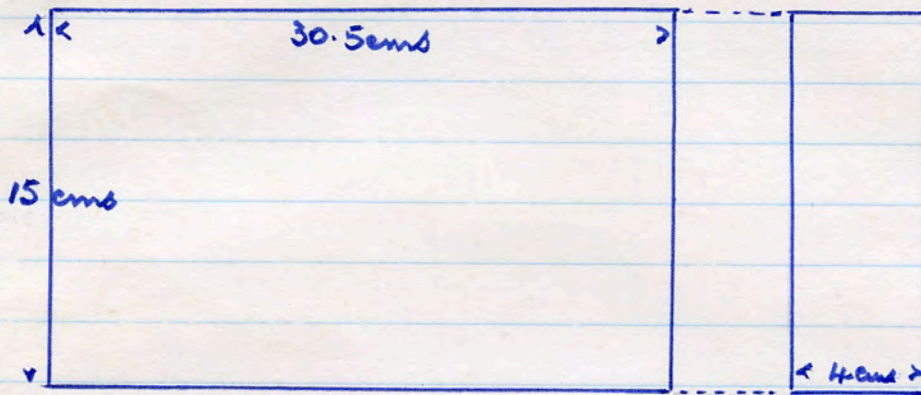

No name FGD 29 red wire run, 1 face edge & face side dressed T.C.

4947

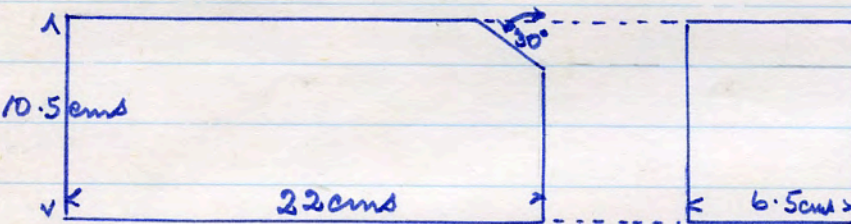

7 1/2 lbs

No name FGD 21 red wire run 1 face side & face end dressed T.C.

4948

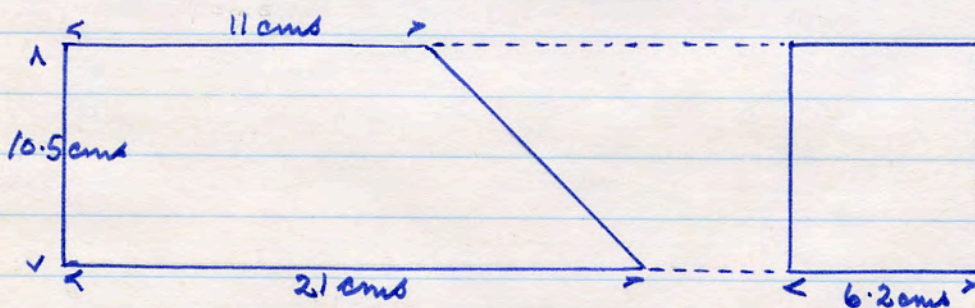

6 1/2 lbs

All above - Acceptor Mori dem. site 11. 8. '90

No name 371 W 169X red dressed 2 face edges
 & 1 end.
 4 1/2 lbs

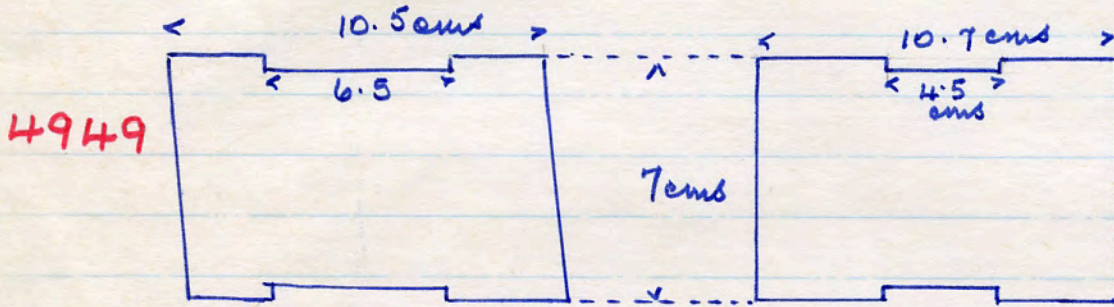

No name. 188 TA red. all surfaces coarse finish
 from wire run machine
 12 lbs.

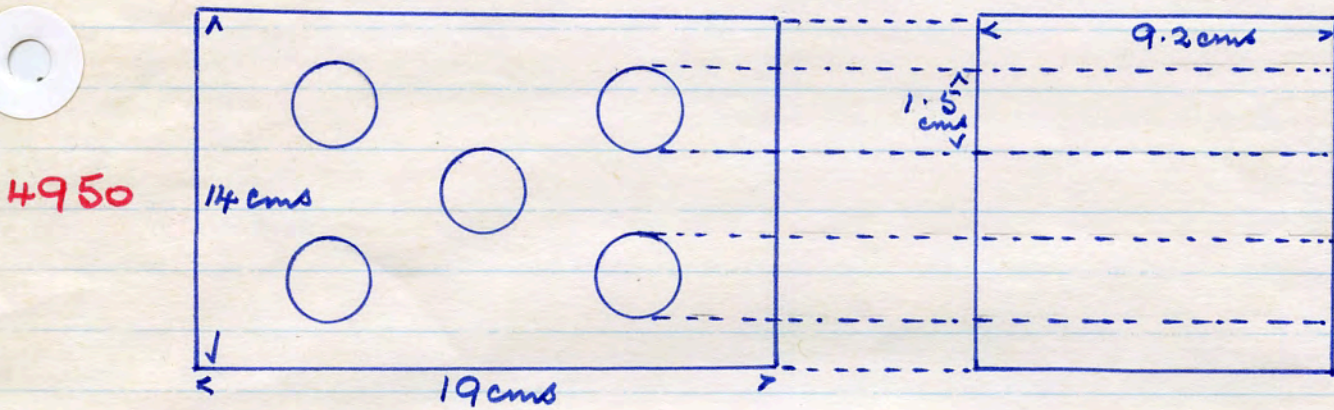

No name FB 7 red 1 face side only dressed T.C.

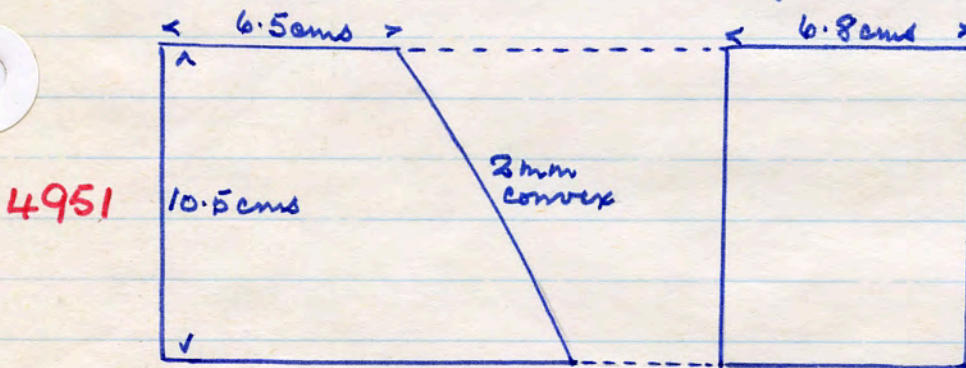

4 1/2 lbs.

All above - Auction Mori dem. site 11. 8. 90

4952

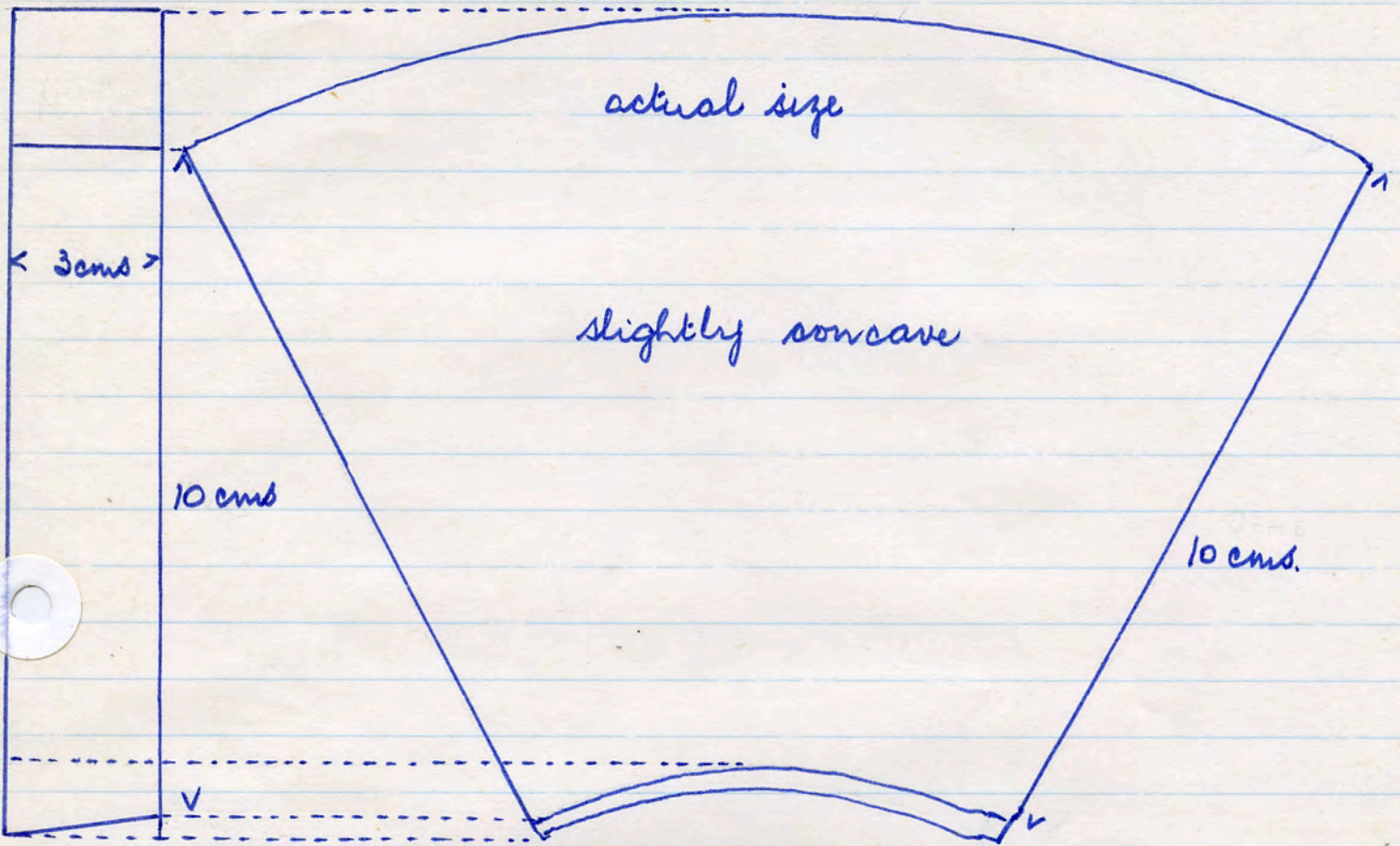

2 lbs
 No name 57 Q 9X red. all sides & edges scratched

No name 61 P 31 red top surface dressed T.C.
 remainder scratched
 5 lbs.
 moulder's marks
 11.

4953

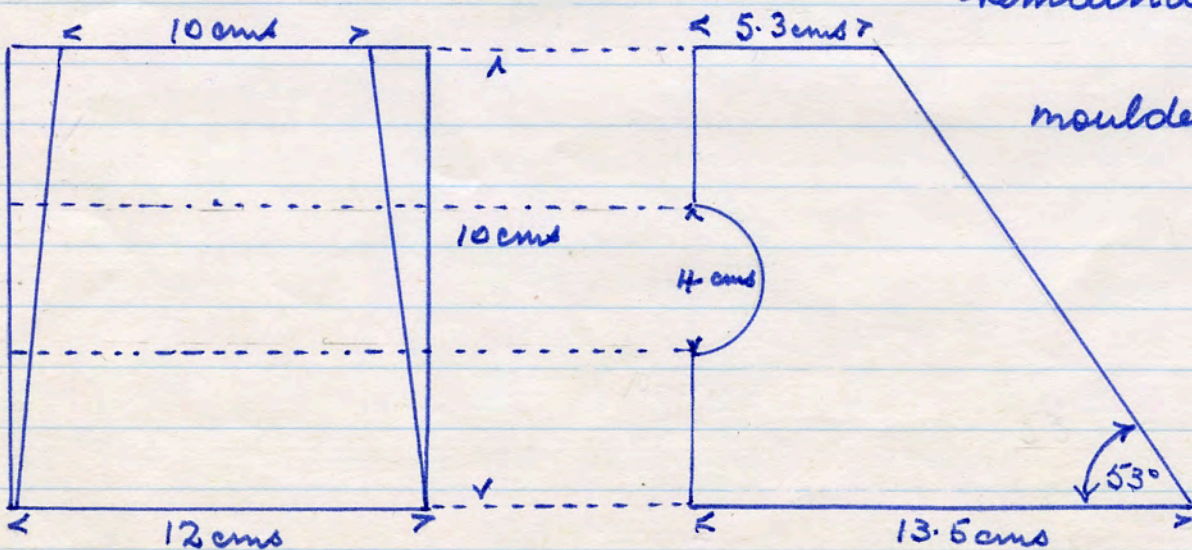

Both above - Acpton Mexi dem. site 11. 8. '90

No name 192 U 2 red internal face only T.C.

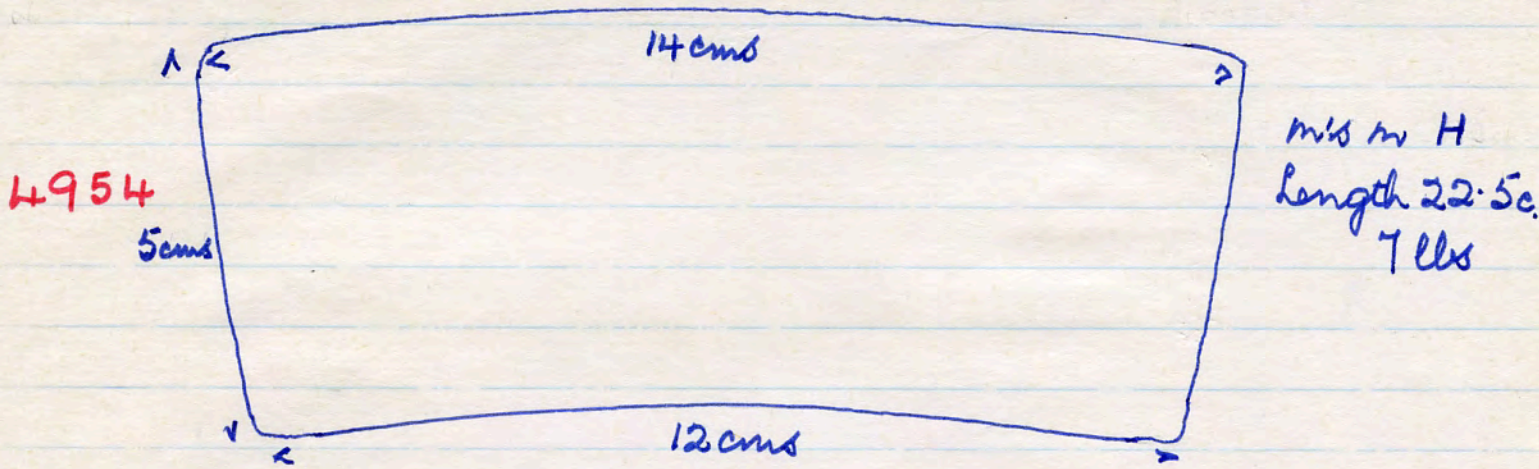

No name 248 T 85 red. 2 face edges 1 face end dressed T.C. 4 1/2 lbs.

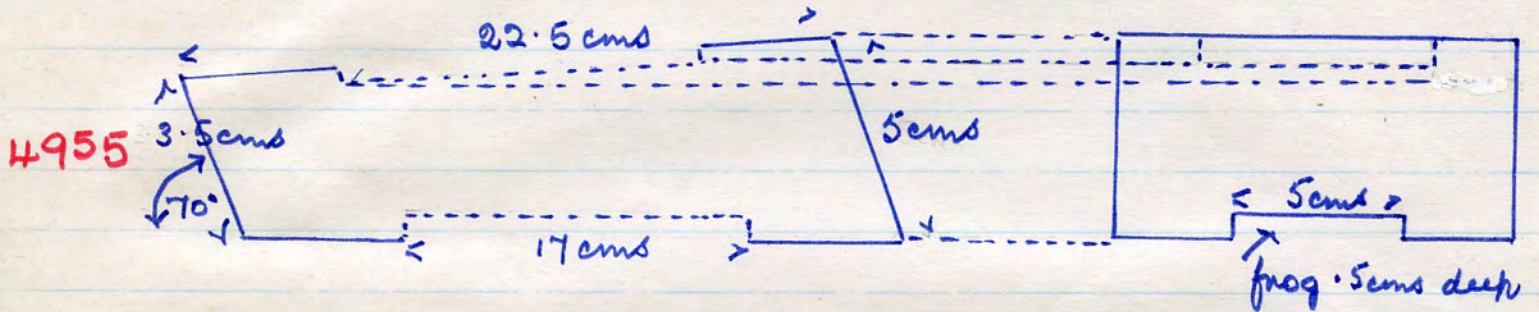

No name 355 W 15 red 1 face edge 1 face end T.C. 7 lbs.

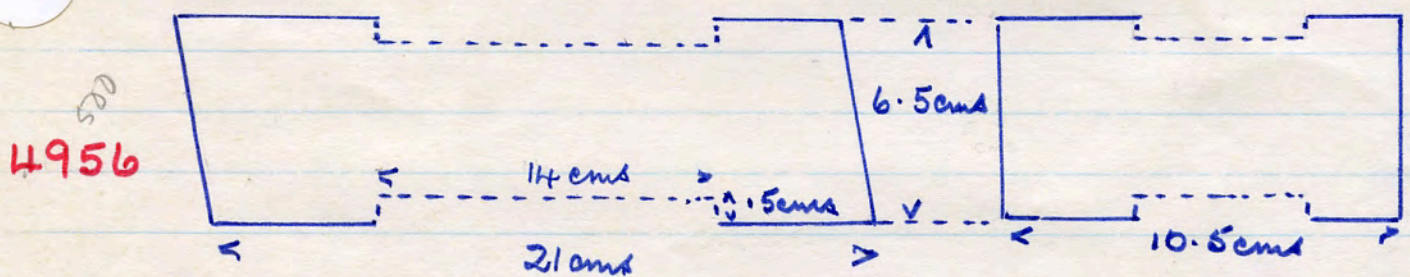

All above - Aspeton Marsh dem. site 11. 8. '90

No name 21N17 red T.C shale gauged bricks.

4957

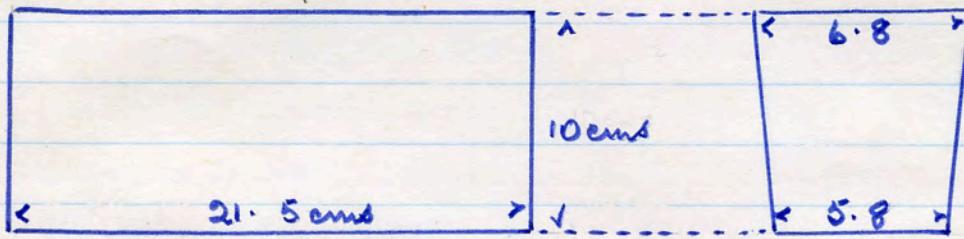

7 lbs

No name 40K 212 red. 2 face edges dressed T.C

4958

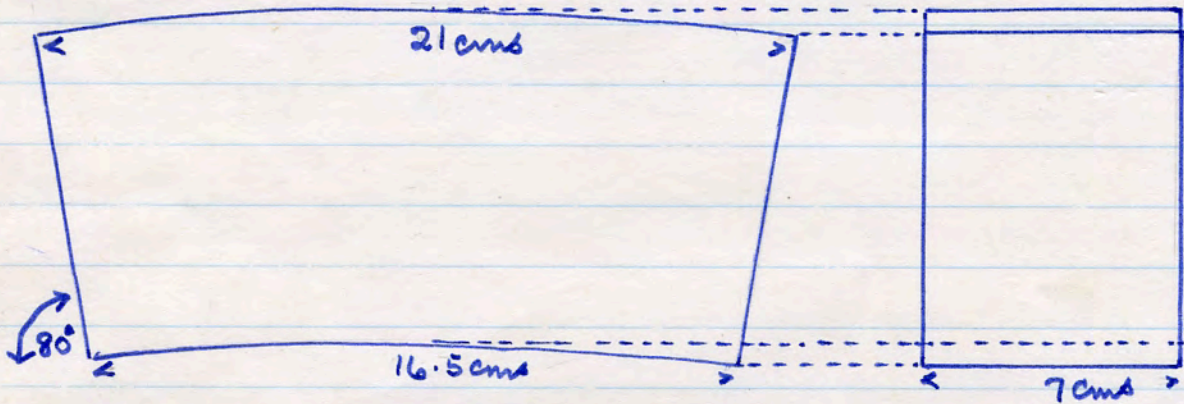

7 lbs

No name 56P3 red all four sides dressed T.C

4959

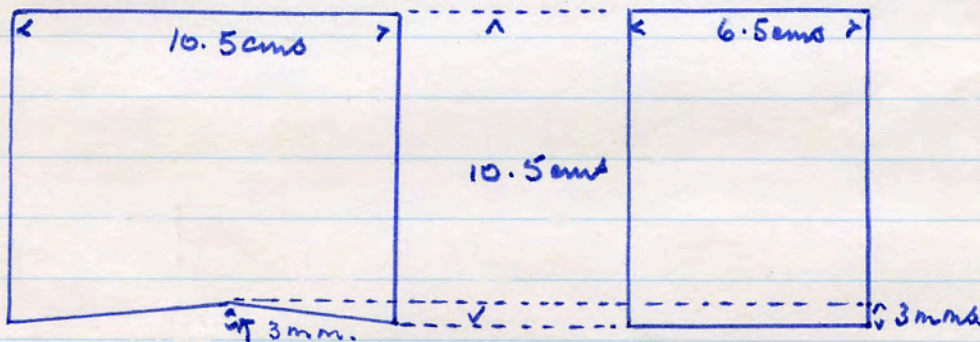

3 1/2 lbs

No name 14P33 red wire run smoothed over

4960

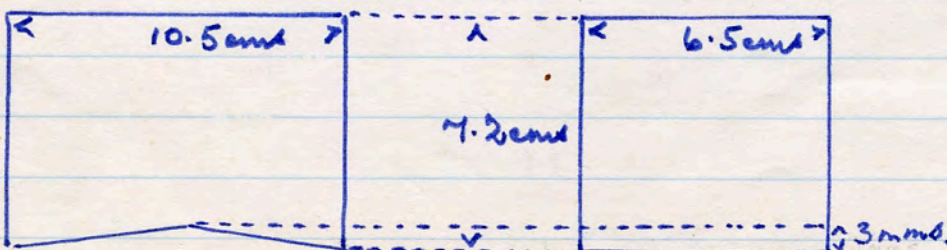

3 1/2 lbs

All above - Acpton No. 1 dem. site - 12. 8. '90

No name 14 P 51 red only smoothed over.

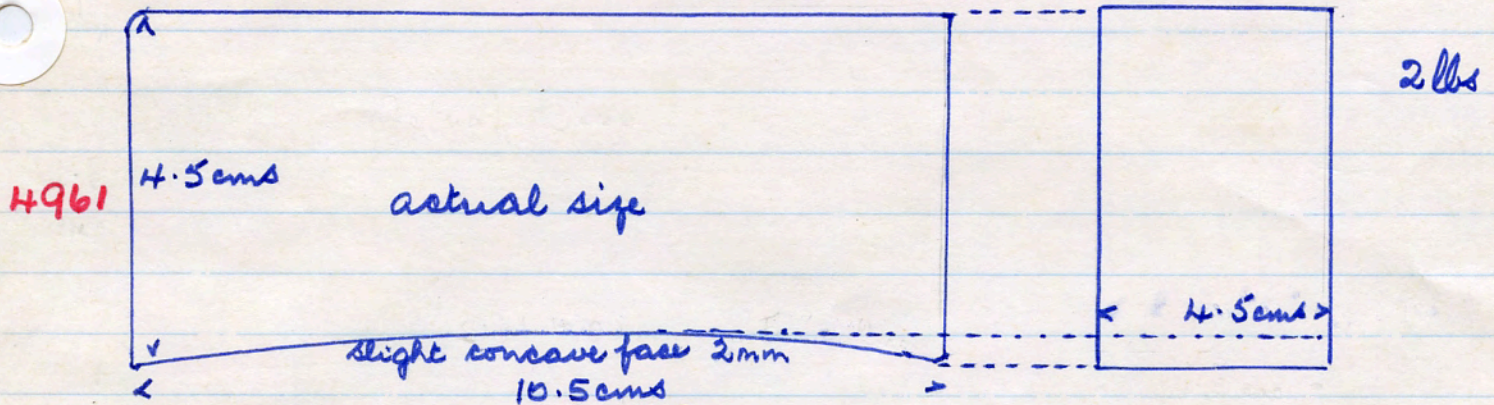

Acetone Moni dem. site 21. 8. '90

14 P 51 red only smoothed over 2 Face from ... Edge

wt 2 lbs

4.5 cm

No name 14 B 40 red. each edge nosed

19.5 cms

2 lbs.

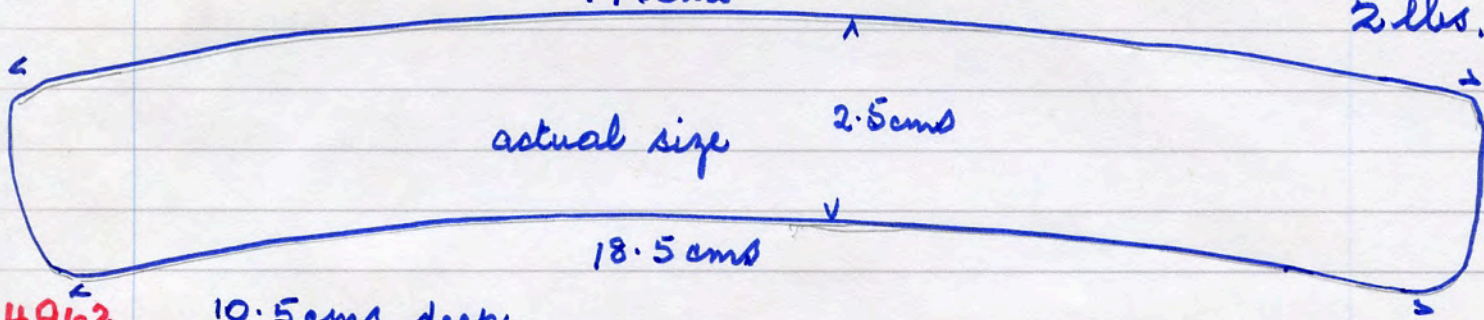

4962

10.5 cms deep

2 edges & 2 ends, face side dressed T.C.

No name 14 B 35. red. each edge nosed 2 lbs.
2 ends & back dressed T.C. face edge chamfered

18.5 cms

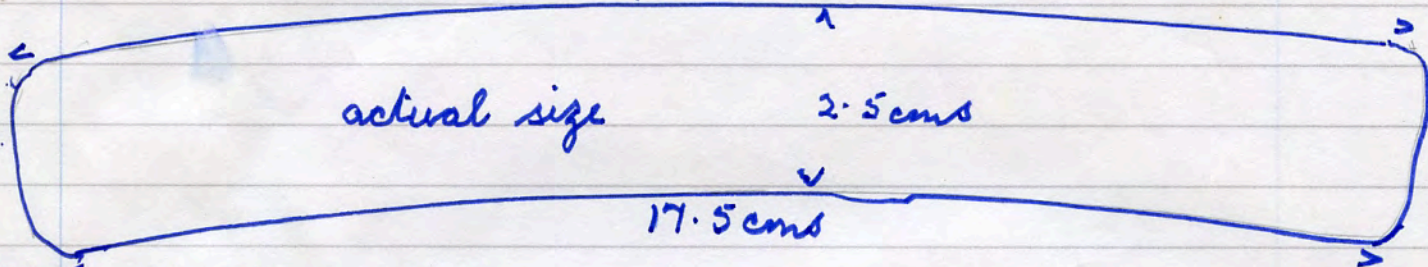

4963

10.8 cms deep

No name 239 W 2. red 1 face side, 2 face ends T.C.

16 cms

2 lbs

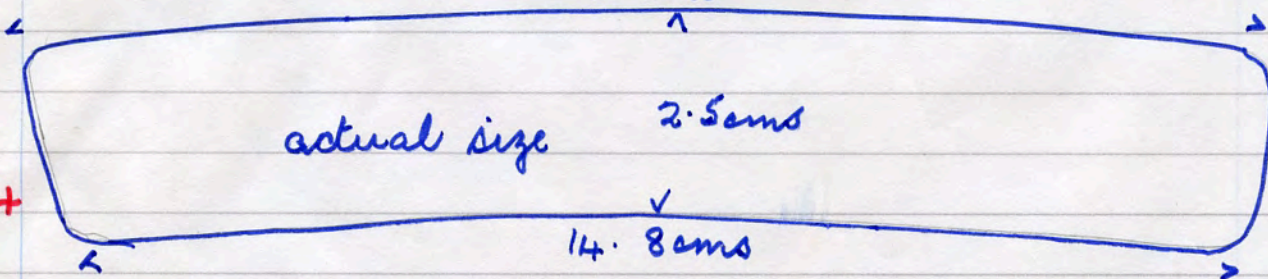

4964

13.5 cms deep

moulder's mark II

All above - Acpton Mori dem. site 21. 8. '90

No name 52 N 28 red. scratched in preparation for dressing

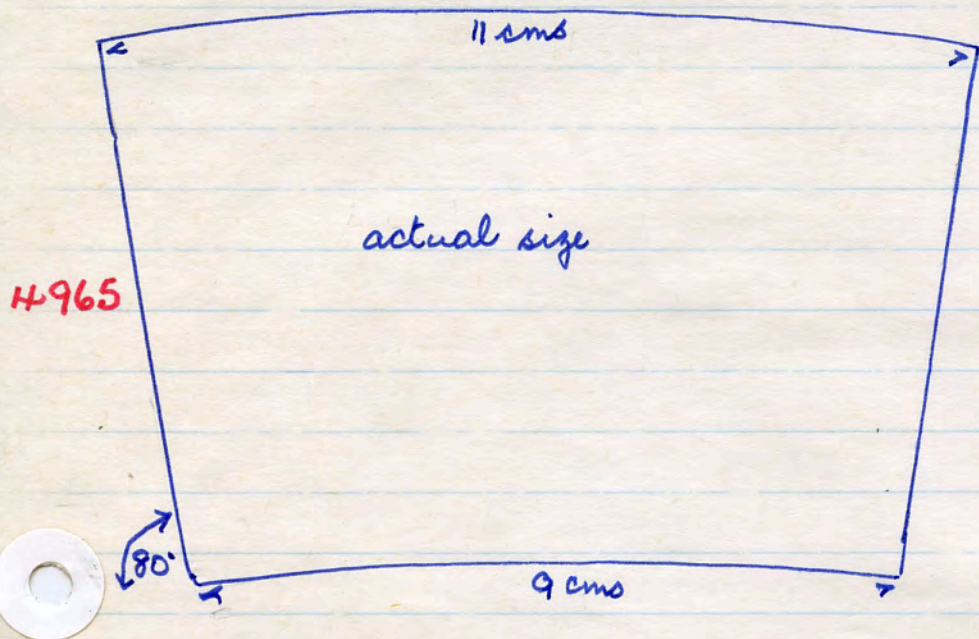

moulder's mark HB
length 21.5 cms. 7 lbs.

No name 348 TCR
red

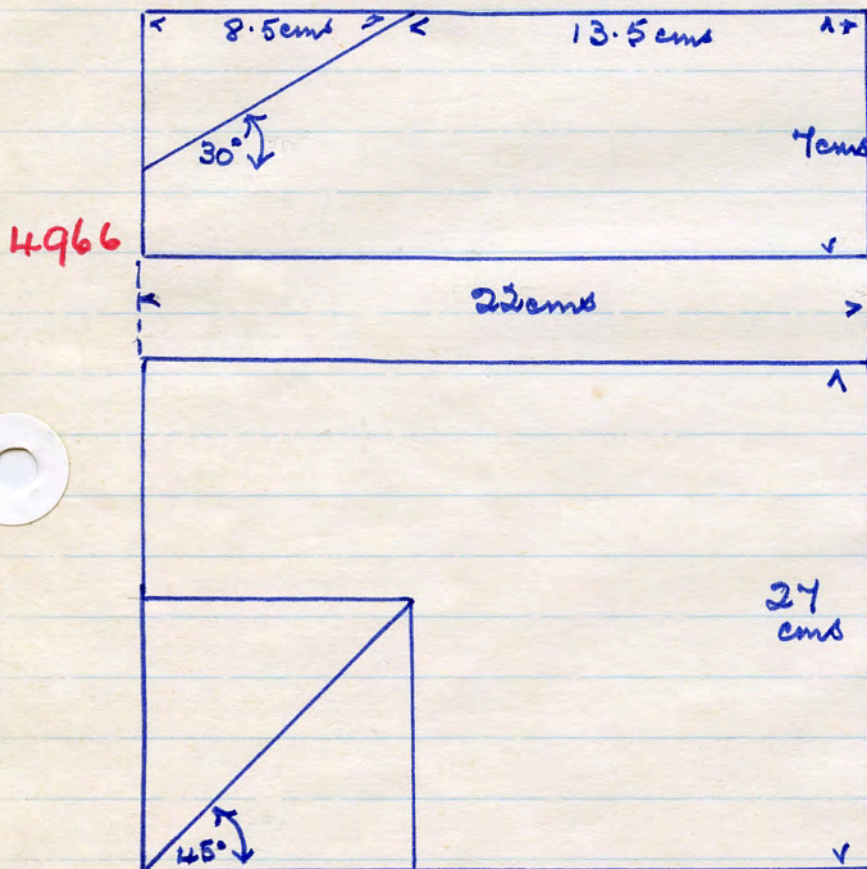

21 lbs

No name 14 P 27 red
3 edges dressed T.C.
4 1/2 lbs

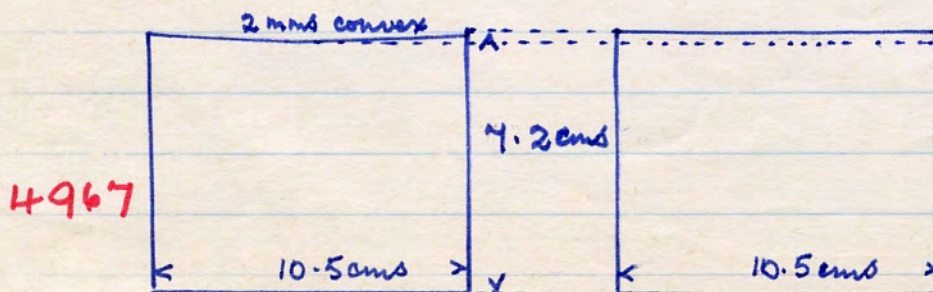

All above - 12. 8. '90
Acceptor Hori dem. site

No name 1QE red. all face edges 1 face side T.C.
2 ends & back scored

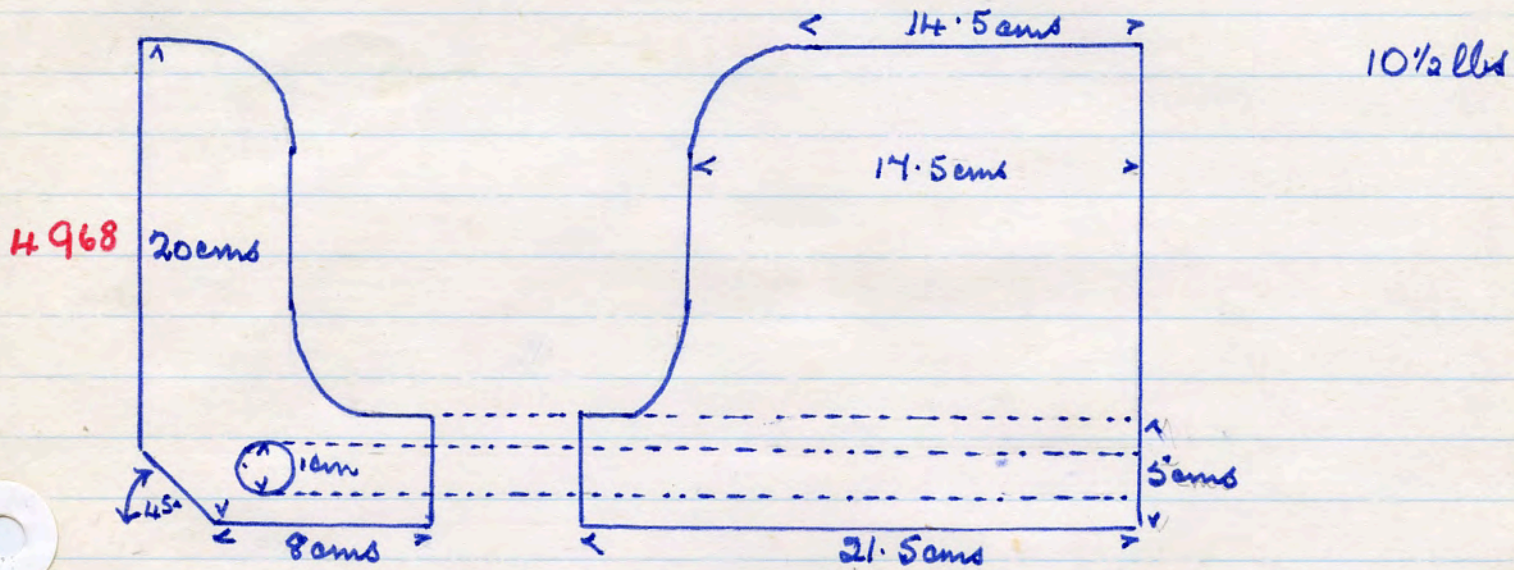

No name 90 F 146 red. back scored - remainder dressed T.C.
1 lb.

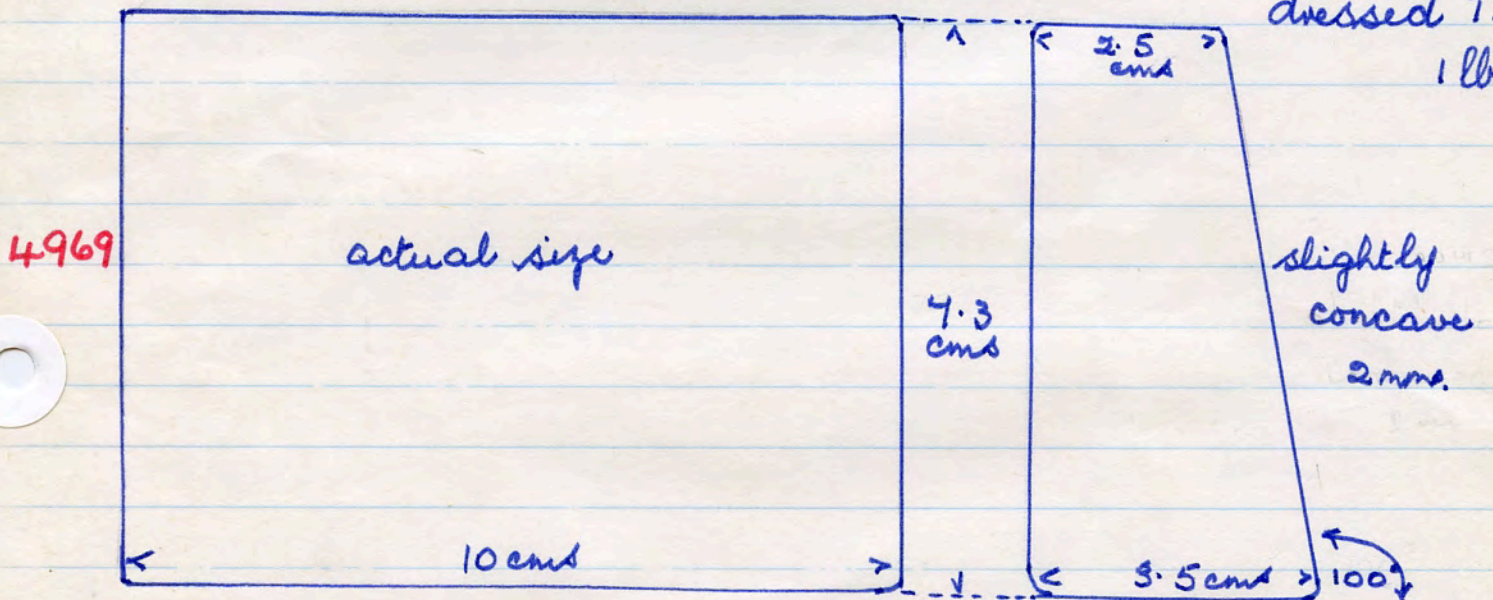

No name EE1 red wire run, smoothed all round
1 face edge TC.
concave. 7 lbs.

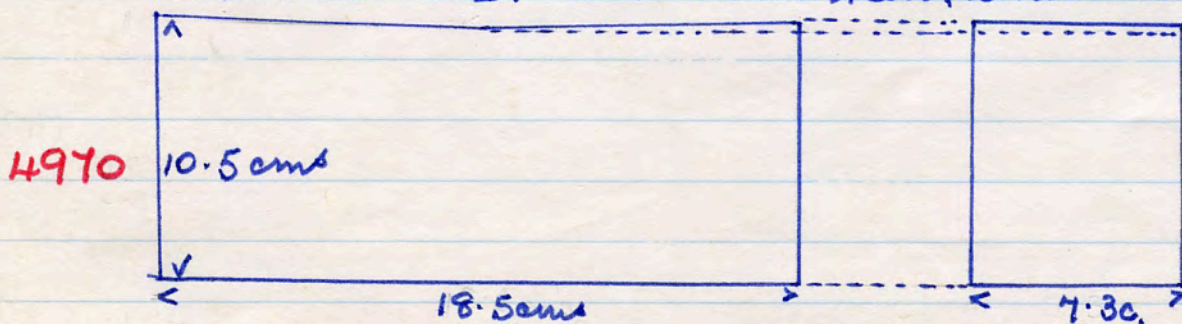

All above - Acceptor Maxi dem. site 13 8. 90

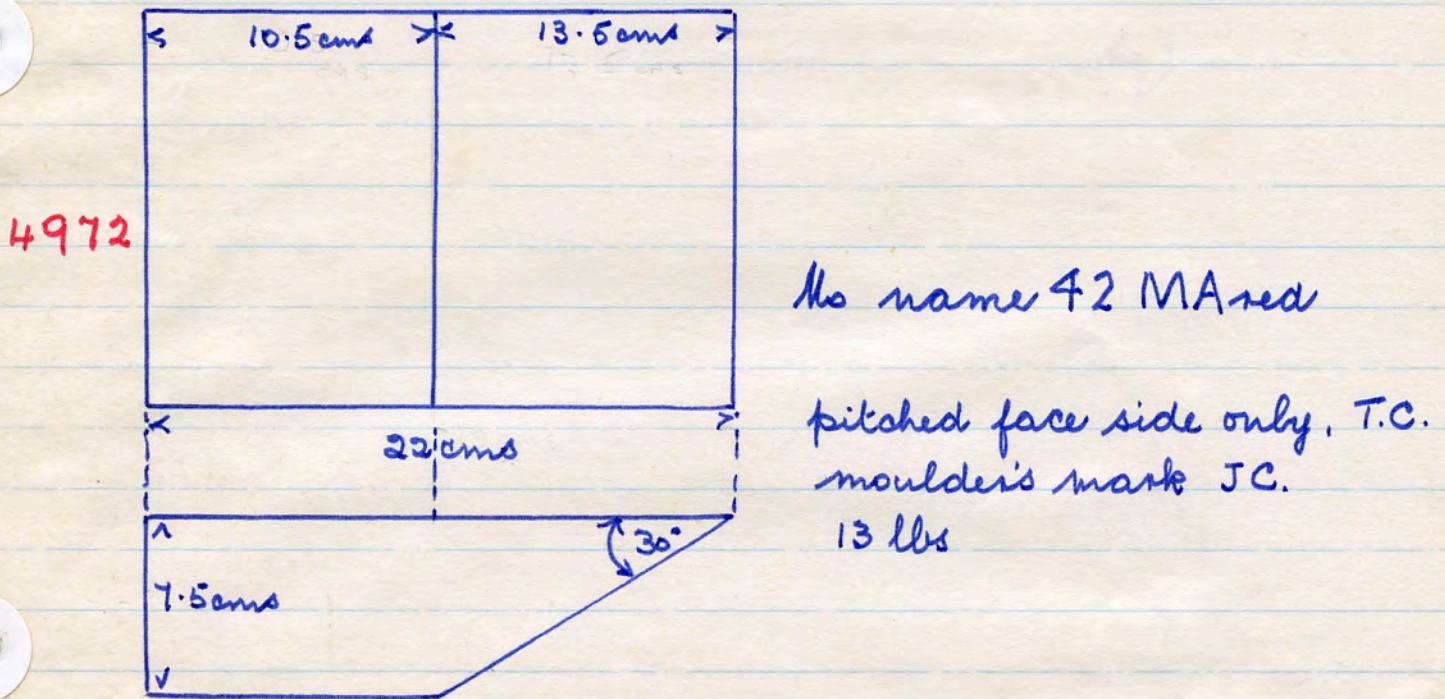
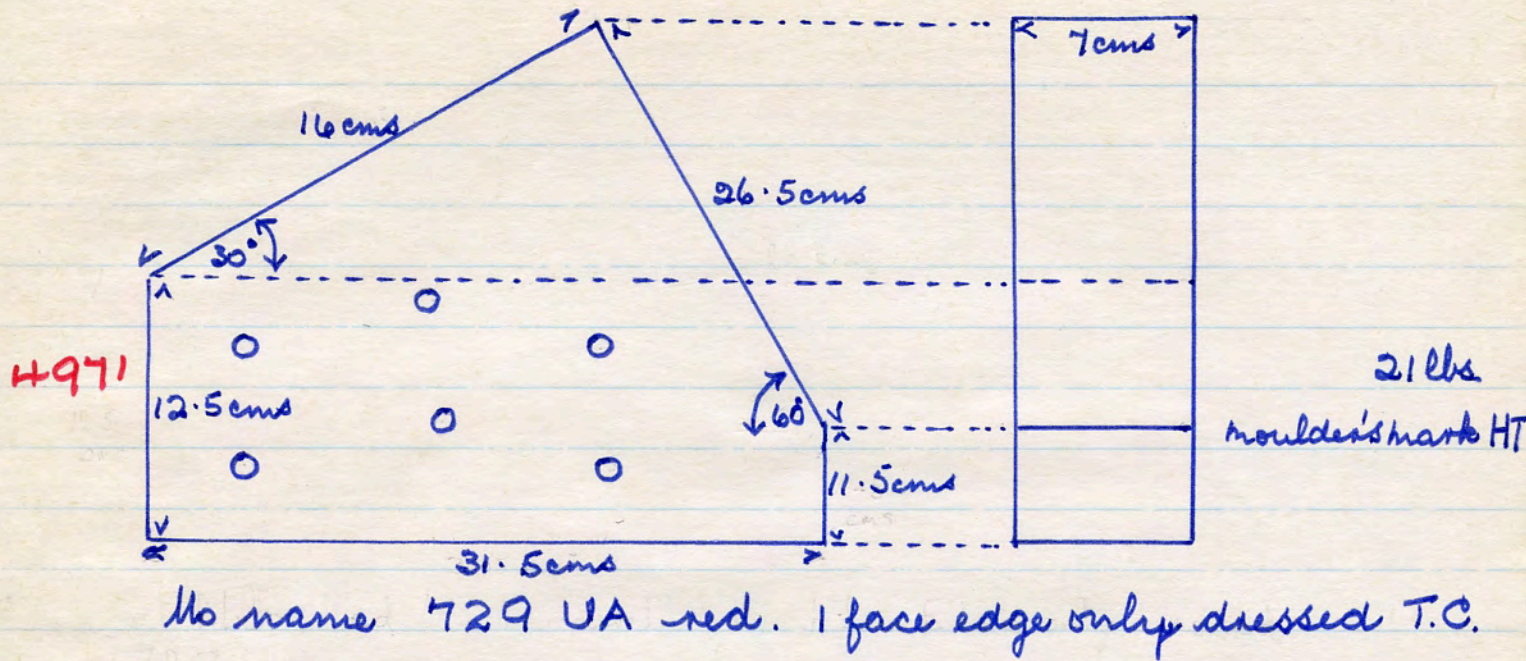

Both above - Acfton Mori dem. site 13. 8. '90

No name 663 V9. Bowland Brown wall cap end return
 all faces dressed
 edges moulded

4973

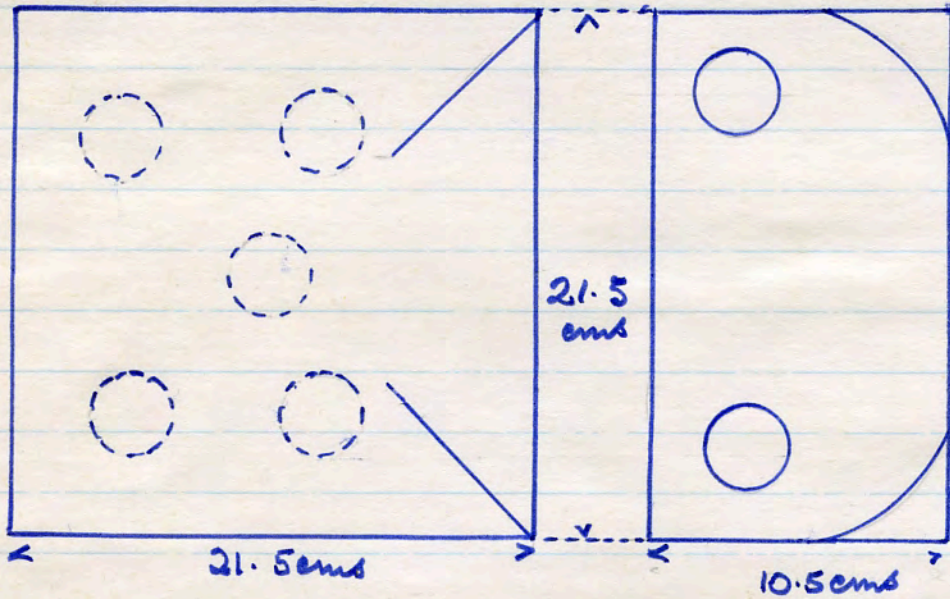

21 lbs.

4974

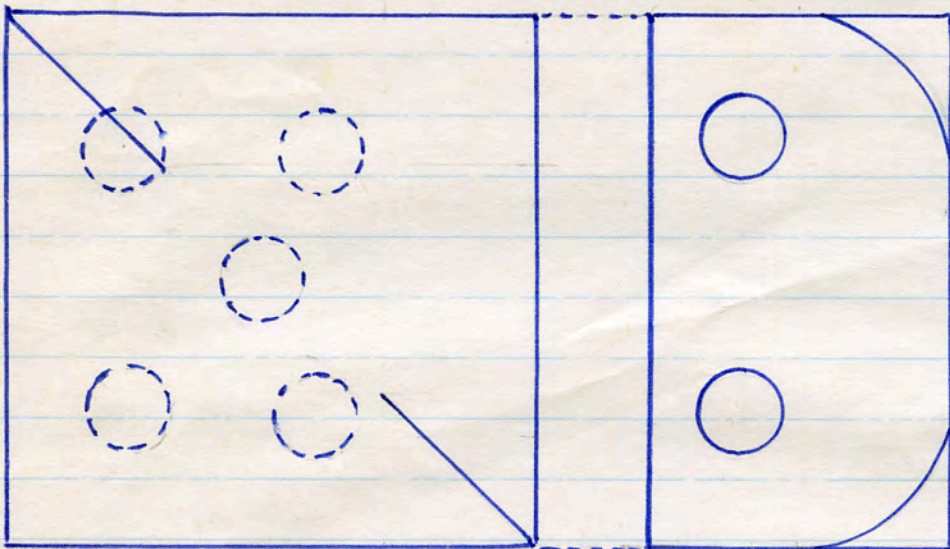

No name 663 V6 Bowland Brown wall cap mitred
 return, quadrant mould. 21 lbs

4975

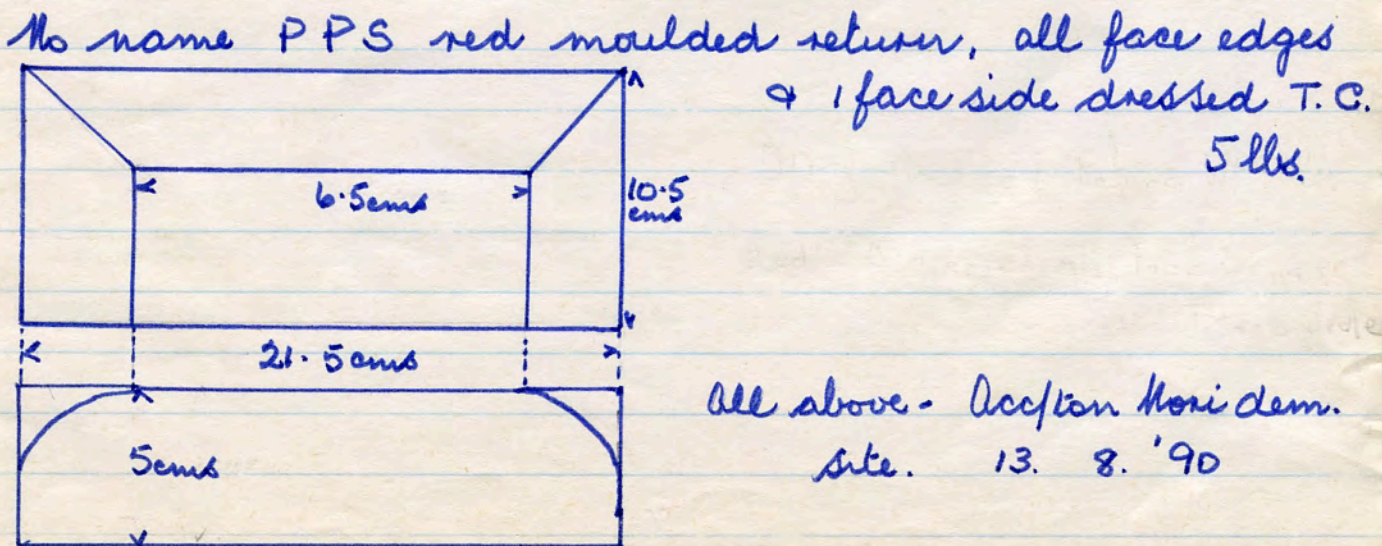

All above - Accpton Moni dem.
 site. 13. 8. '90

No name 778 V IR red wire finish

4976

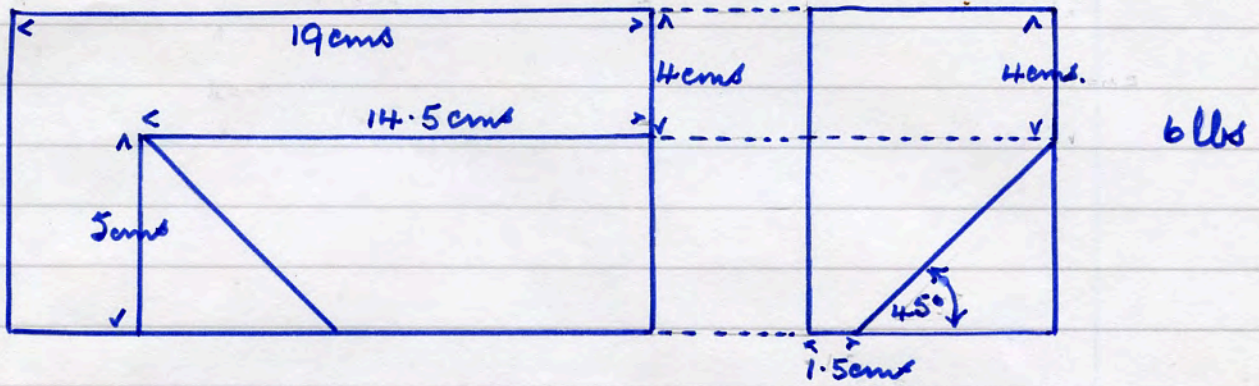

No name PN5XL red. edge & 2 face internal sides T.C.
11 1/2 lbs

4977

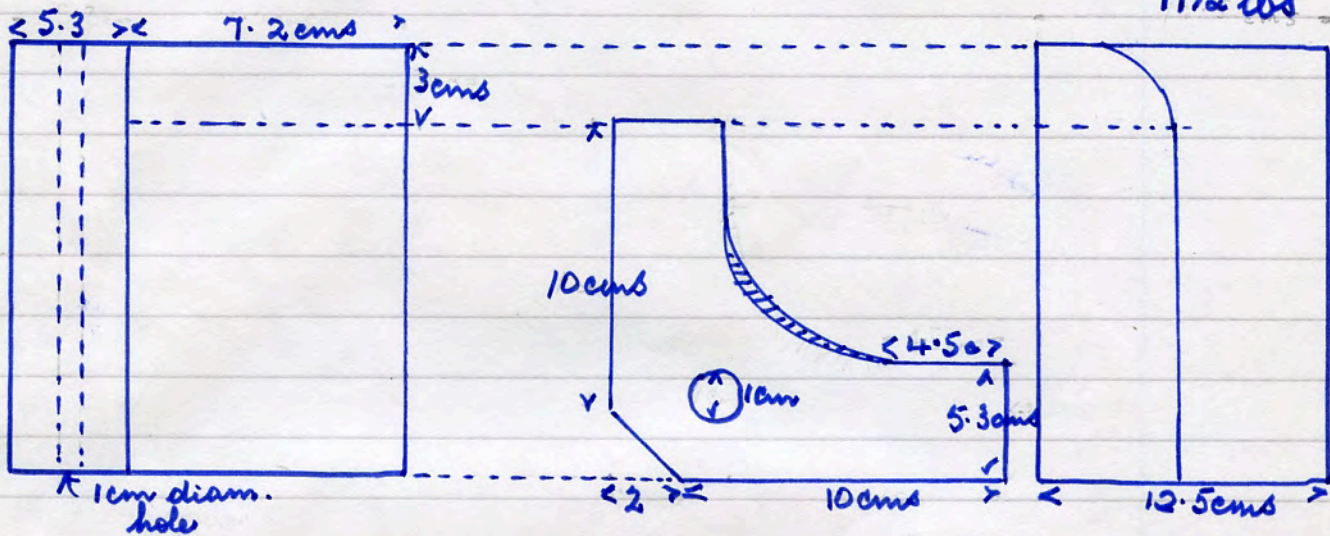

No name PN X BL red. 2 edges, 2 int. faces & both top edges dressed T.C

4978

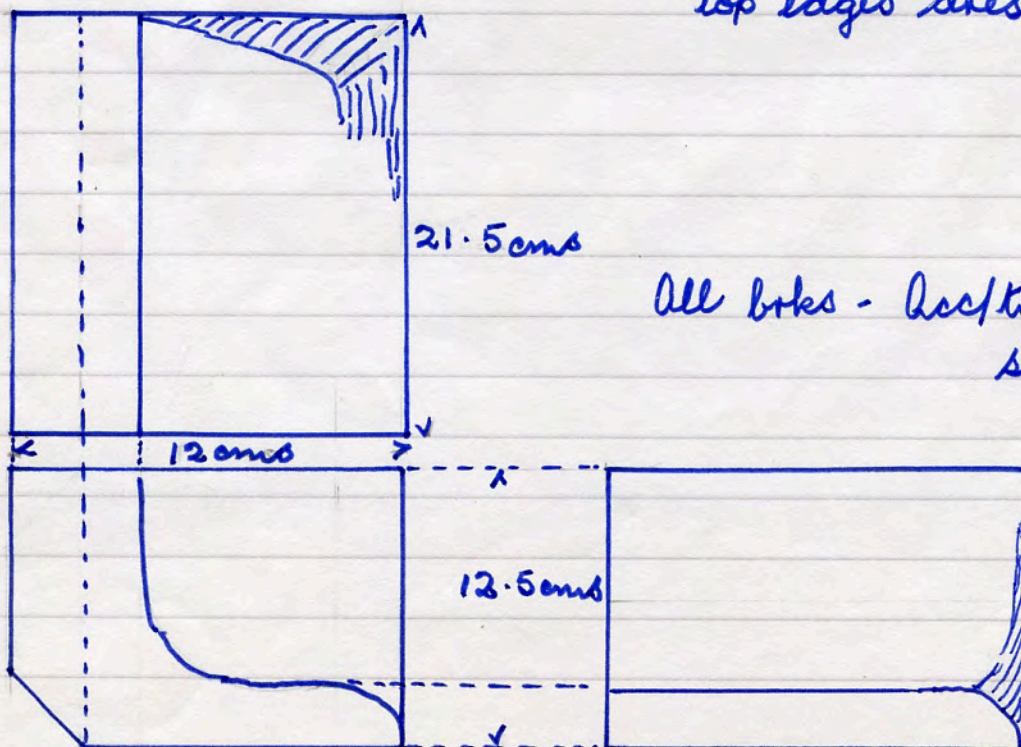

All bks - Accton Mori dem.
site 14. 8. '90

No name ISL red scotia mould return. all faces T.C.

4979

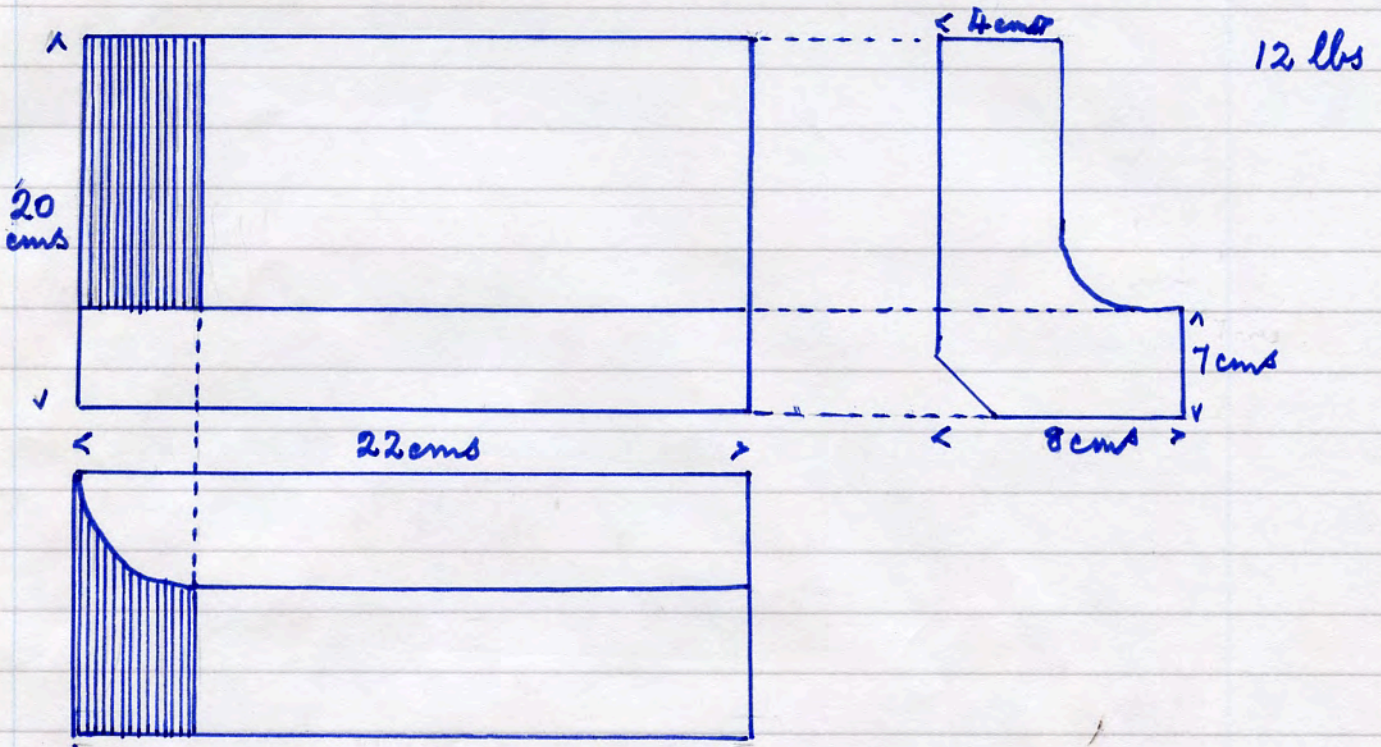

No name ISR red scotia mould return 12 lbs

4980

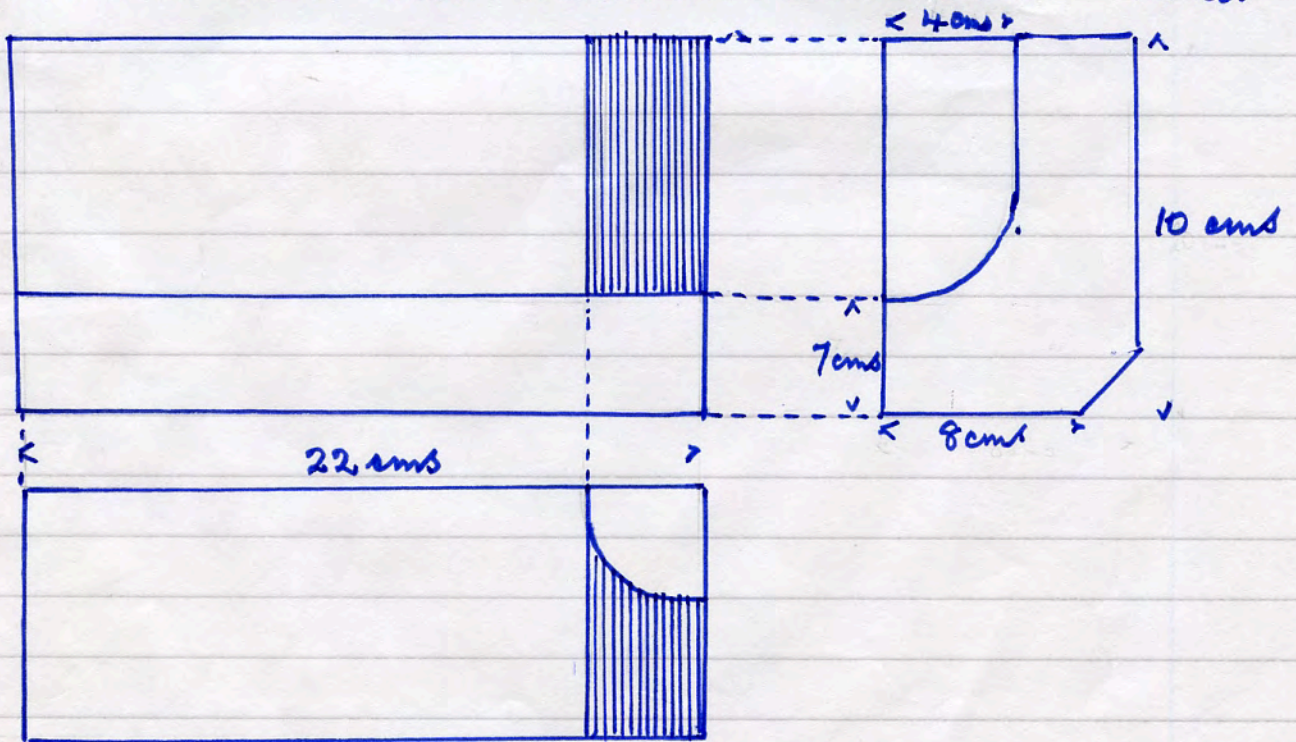

Both above. Accpton Mori dem. site. 14. 8. '90

No name PN5AE swan neck return, all faces T.C
red. 9 lbs

4981

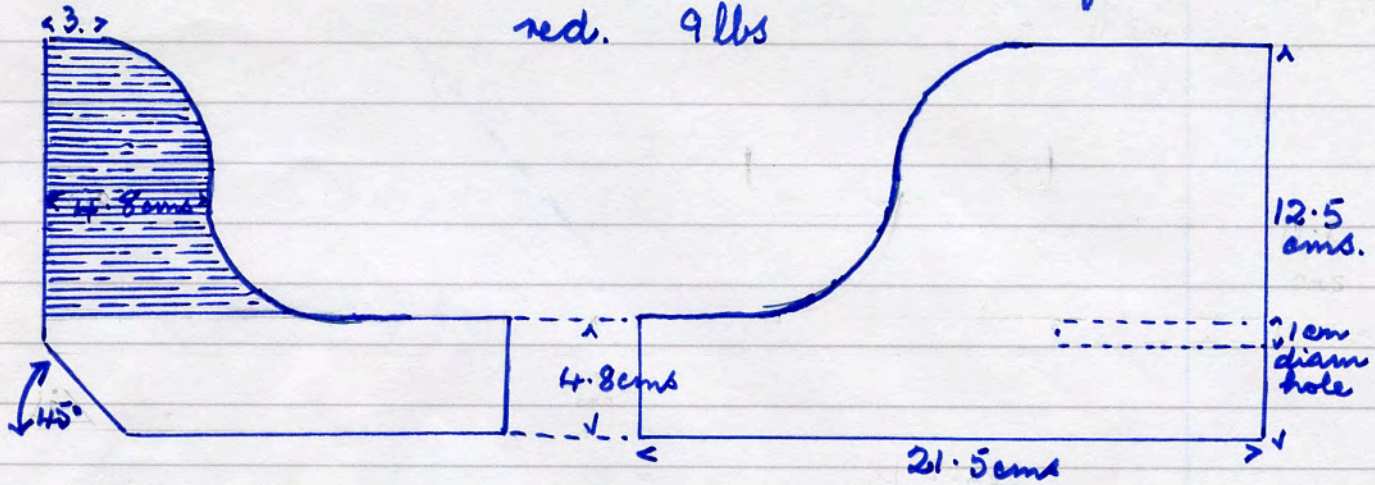

No name 50WR red. Scotia return, all faces T.C
dressed.

4982

12 lbs.

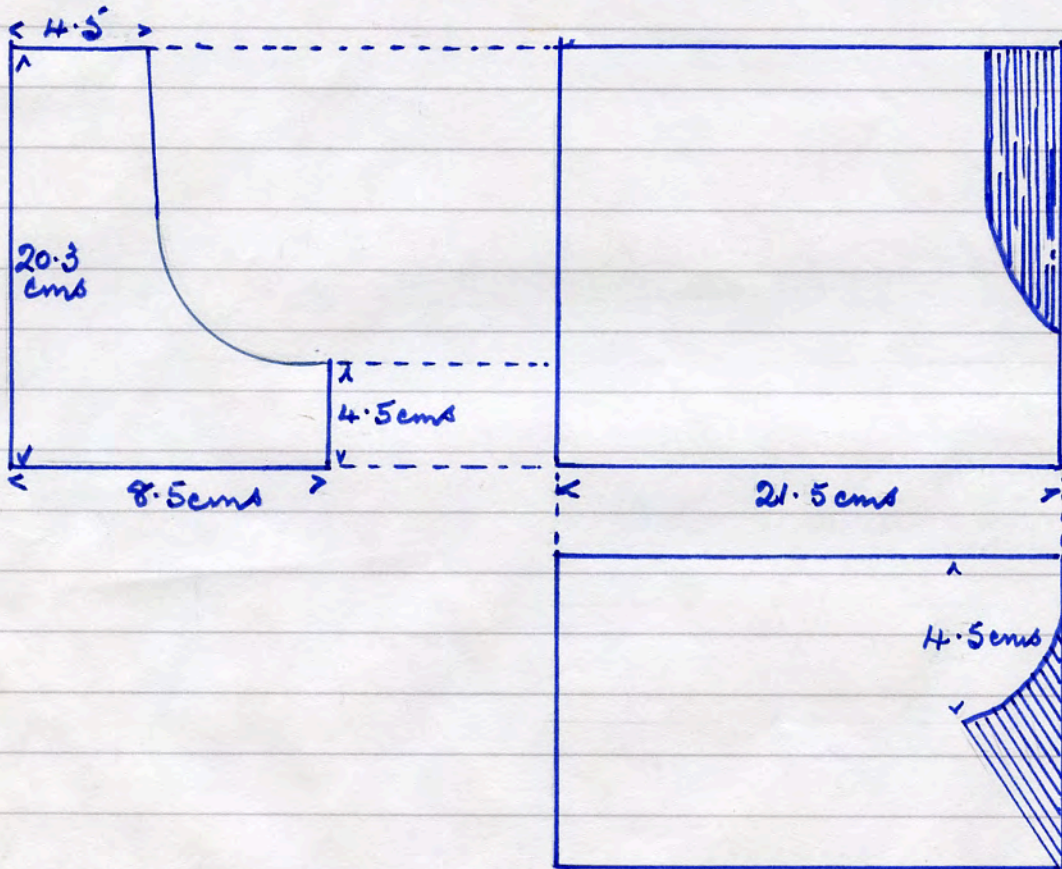

Both above - Acpton. Mari dem. site 14. 8. '90

No name T1 P 7 red. internal faces dressed TC, others scratched

4983

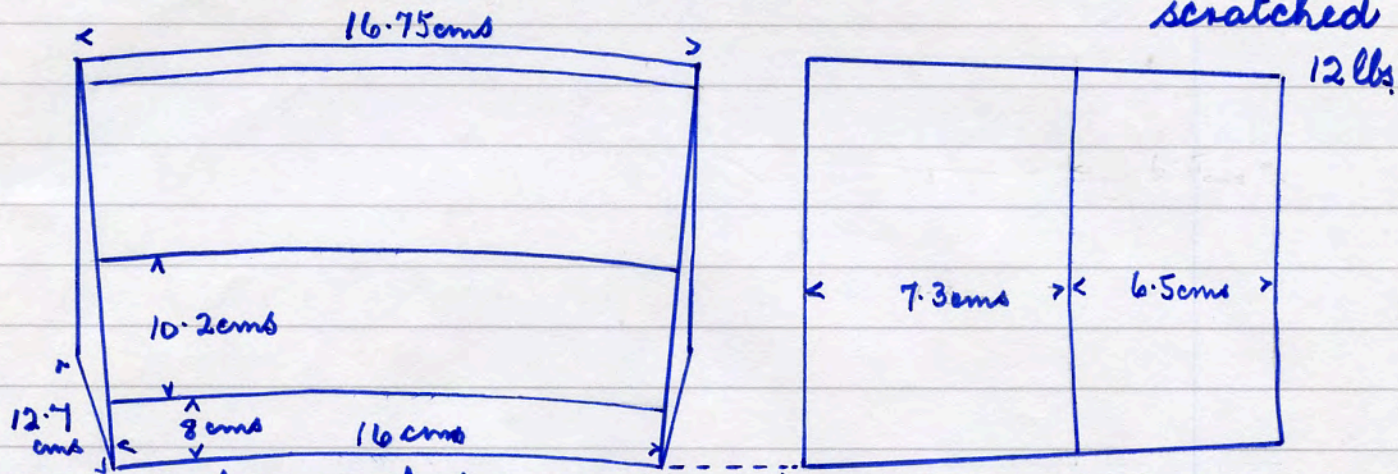

segment of a circle for construction of T.C. container

No name HFA red 1 face edge 1 face side T.C.

4984

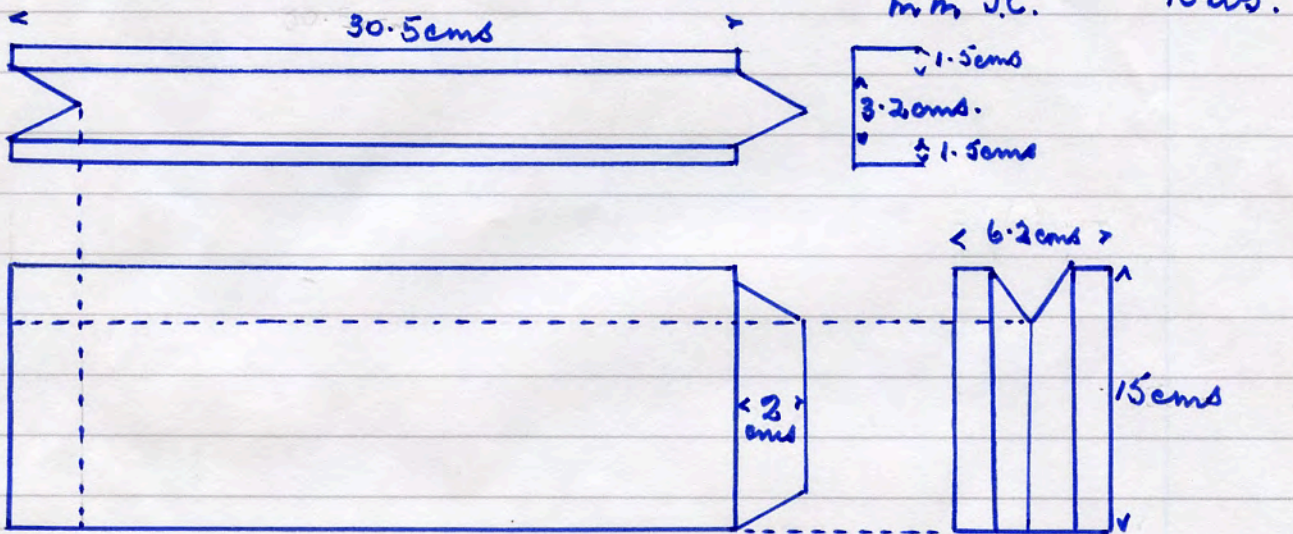

No name 60 N 163 red 1 face end 2 face edges dressed T.C.

4985

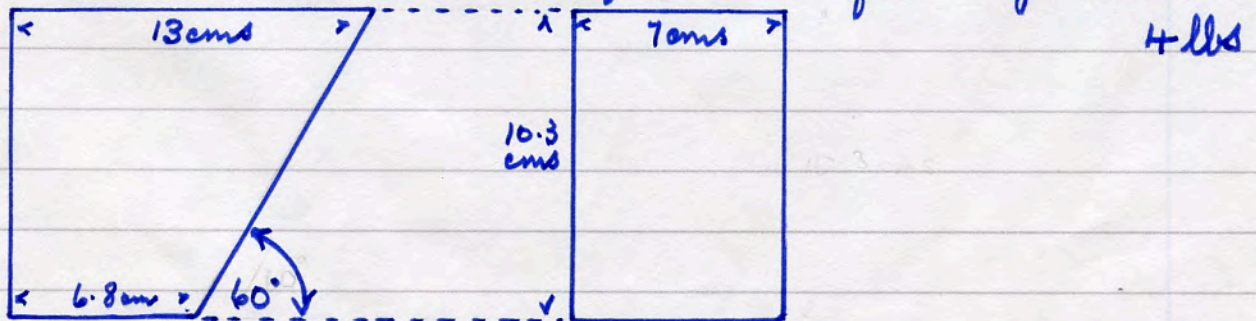

All above - location Mani dem. site 15. 8. '90

No name 576 U red wire run. 1 face side 1 face edge T.C.

4986

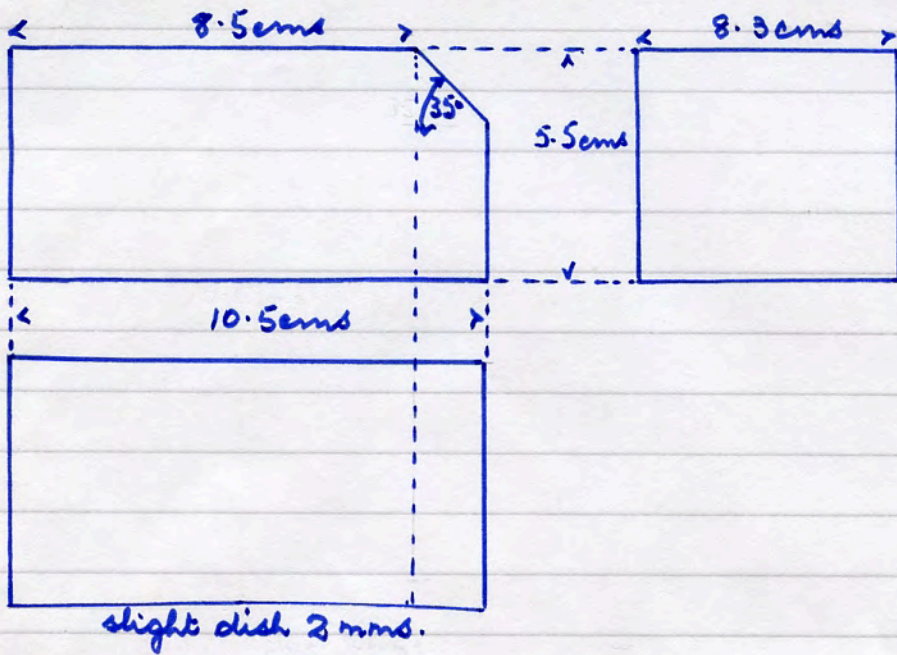

2 1/2 lbs.

No name FBB 16 red wire run. 1 face side 2 face edges dressed T.C.

4987

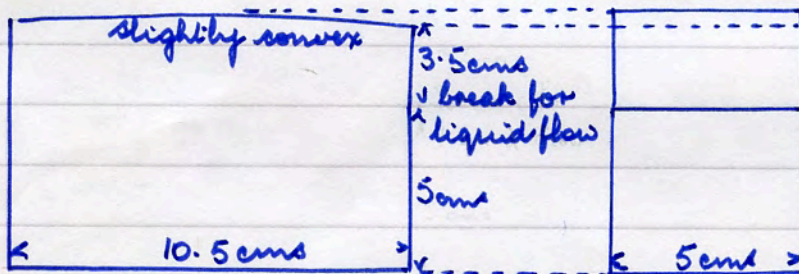

2 1/2 lbs

No name FBB 15 red wire run 3 face edges 1 face side dressed T.C.

4988

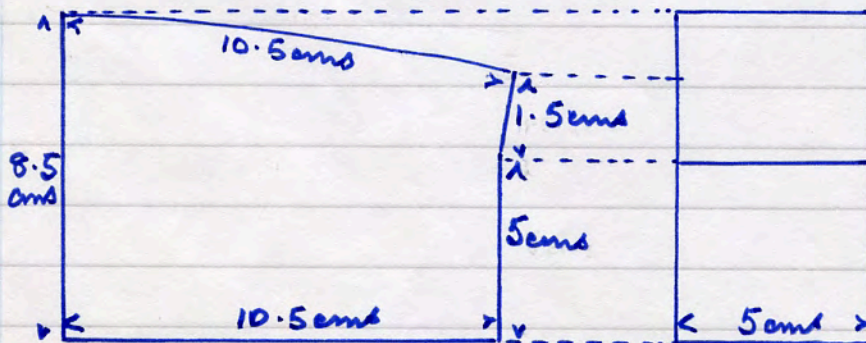

2 lbs

All above - Acroter Mori dem. site 15. 8. '90

No name 1 PL red 1 face side 1 face end dressed T.C.

4989

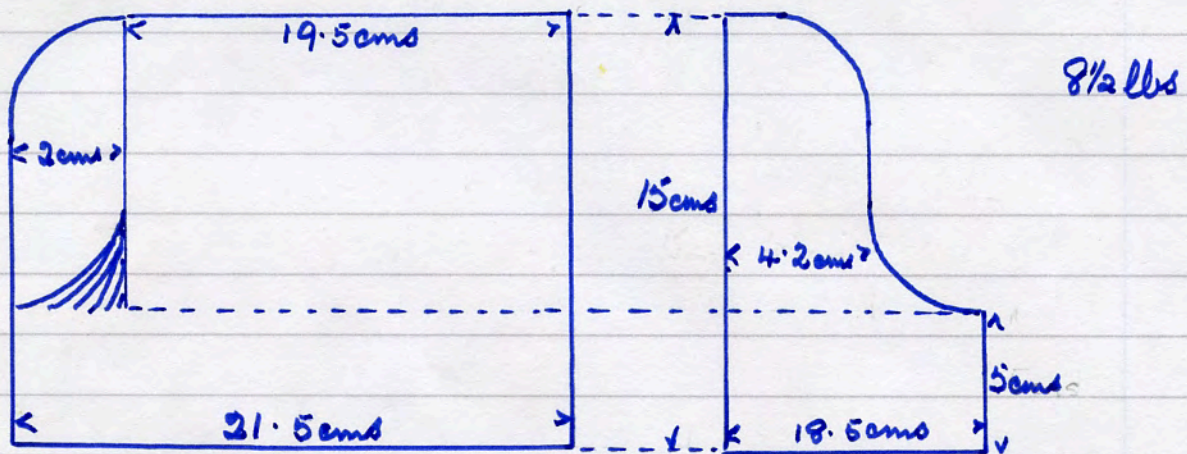

No name 4F 60 red 1 face side only dressed T.C.

m.m. RC

4990

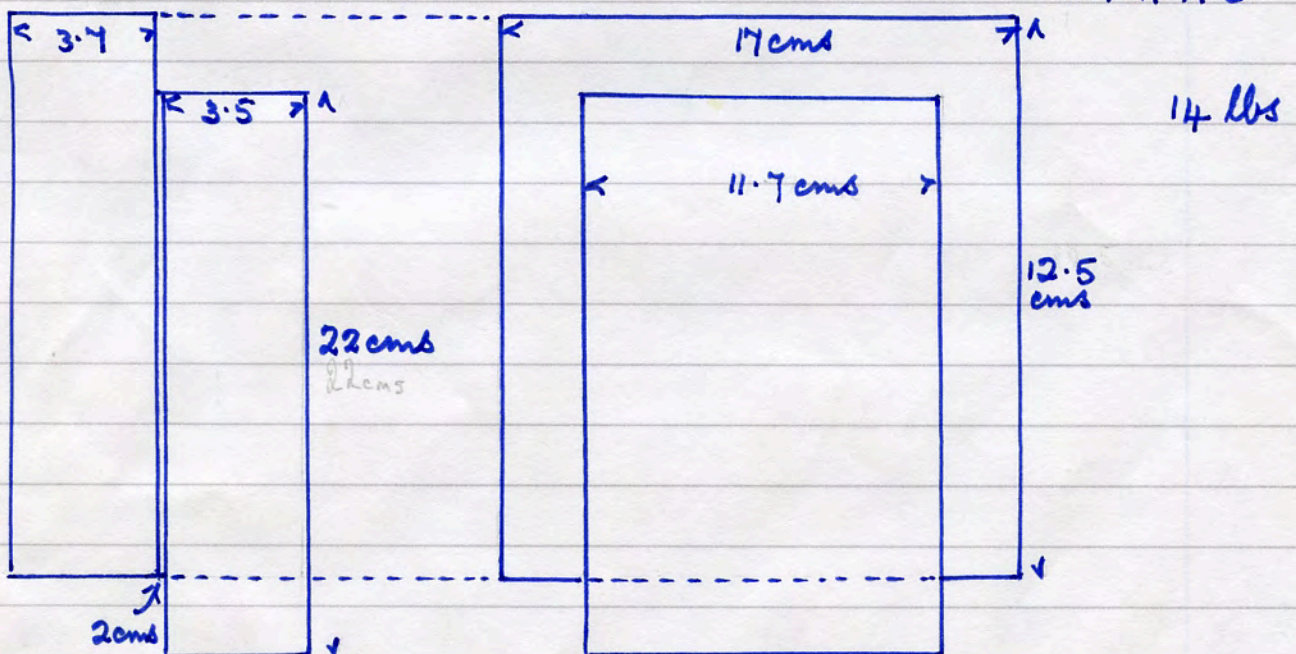

Both above - Accpton Mori dem. site 15. 8. '90

No name HFB red 1 face side only T.C.

4991

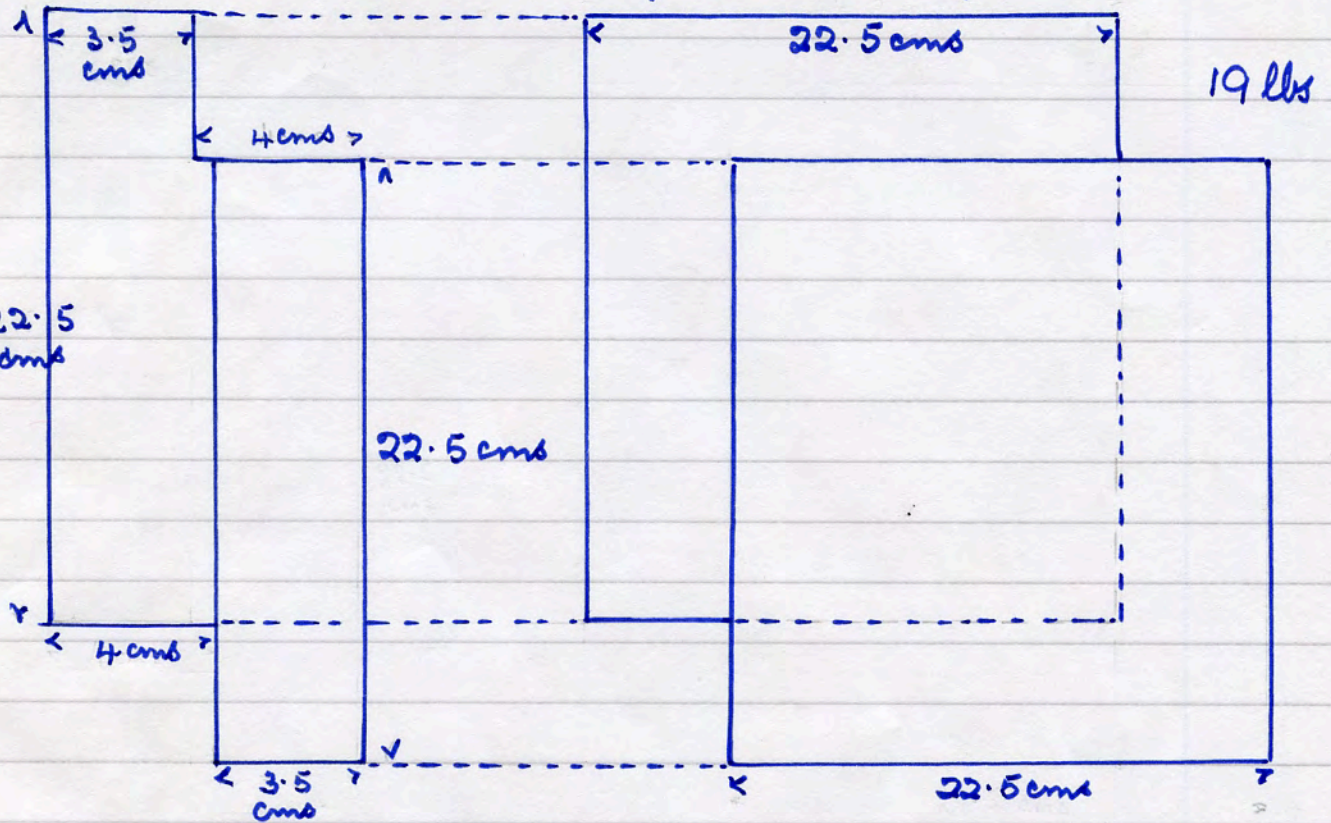

No name 50 WL red. 1 face side 3 face edges dressed T.C.

4992

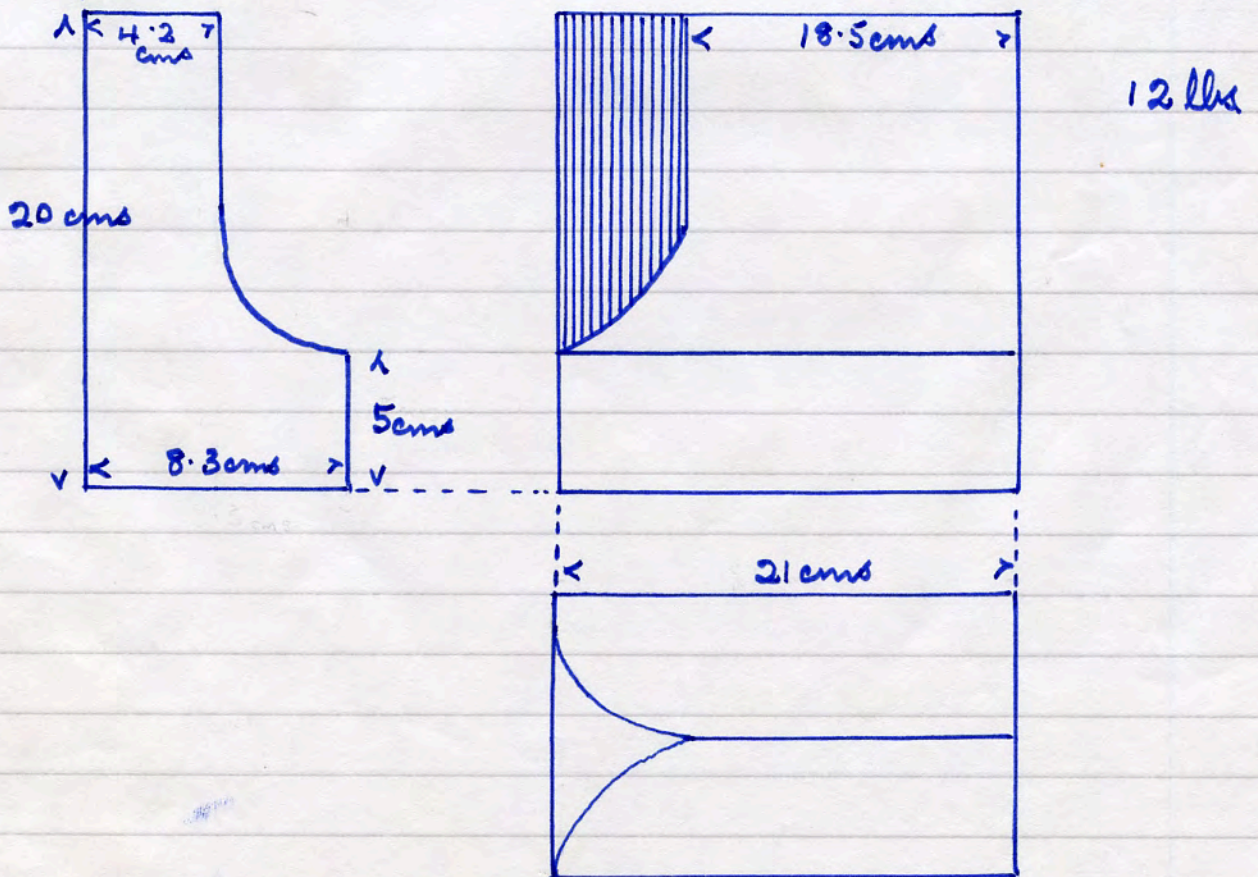

Both above - Acpton Harri dem. site 16. 8. 90

No name. 56 H 8 red 3 face sides dressed T.C.

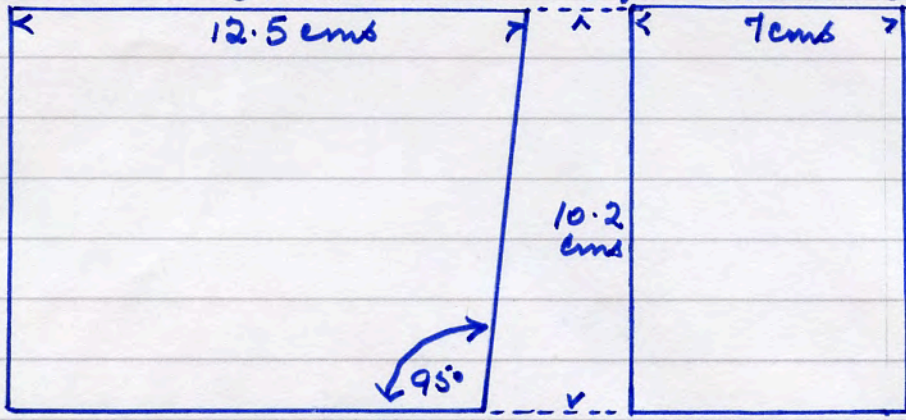

5 lbs.

4993

No name 76 P 16 red 1 face edge dressed T.C.

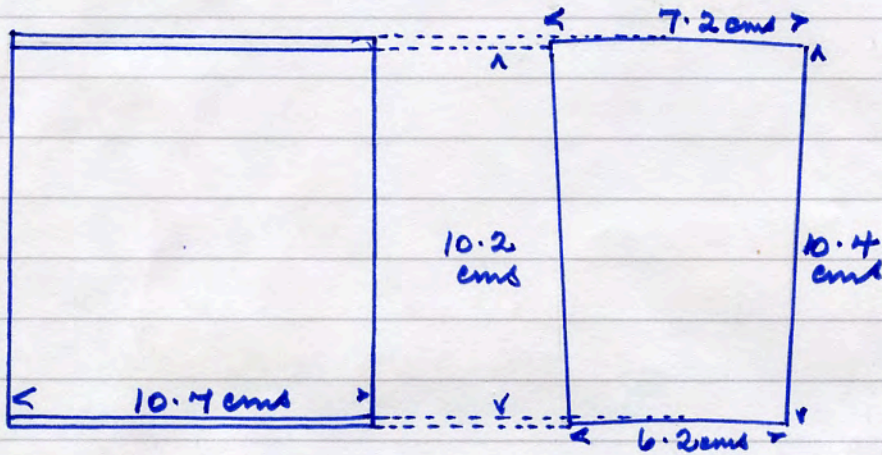

3 1/2 lbs.

4994

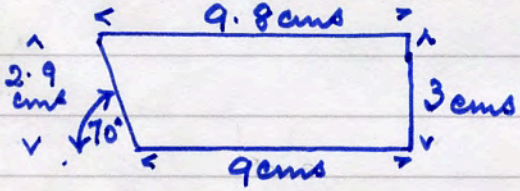

No name 944 VCC red 1/2 lb.

4995

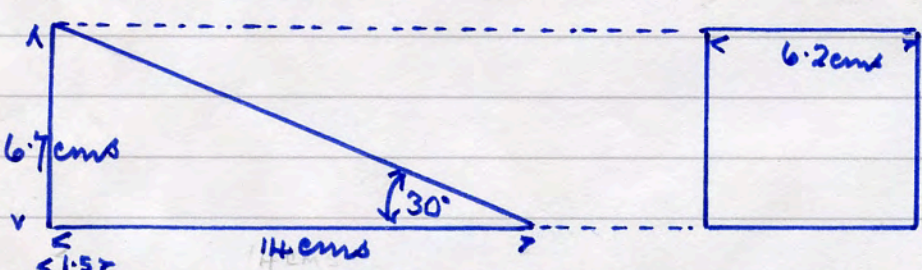

No name FHD 34 red 1 lb 2 face sides T.C

4996

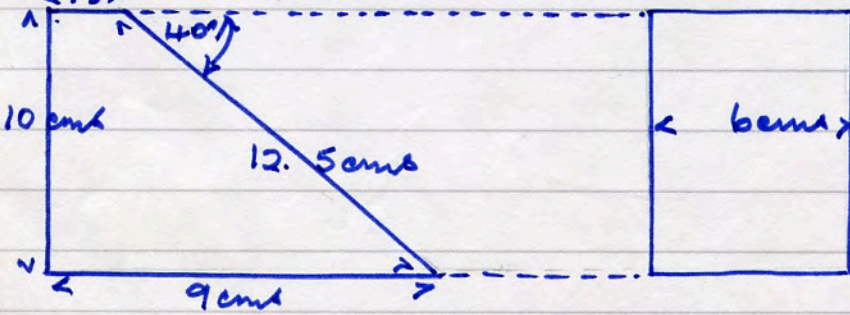

No name. FHD 20 red 1 lb. 2 face sides T.C.

4997

All above - Acceptor Mori dem. site 16. 8. '90

No name 54 PT red 1 face side 2 face edges dressed

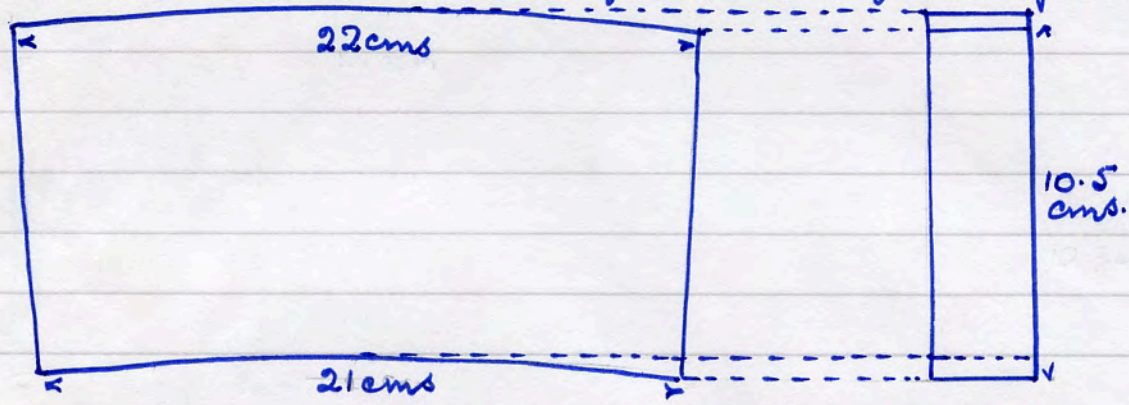

T.C.
2 1/4 lbs

4998

No name. 24 B6X red 1 face side dressed T.C.

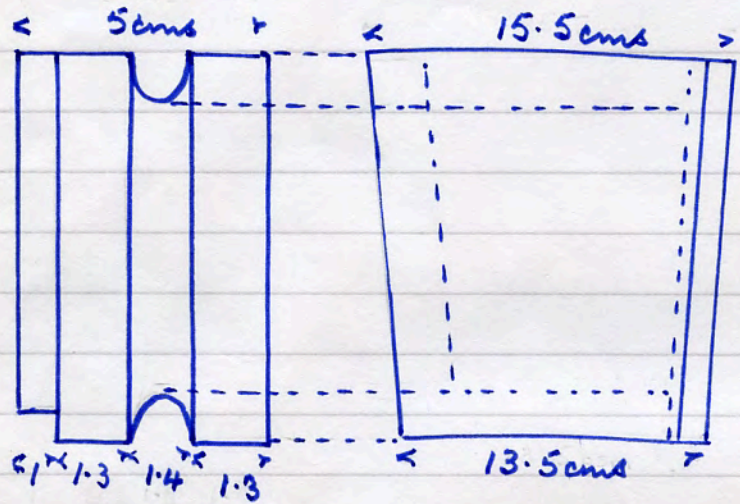

m.m. DW
6 lbs.
• 5cms camber
• 5cms convex on length

4999

Both above - Accpton Mori dem. site 16. 8. '90

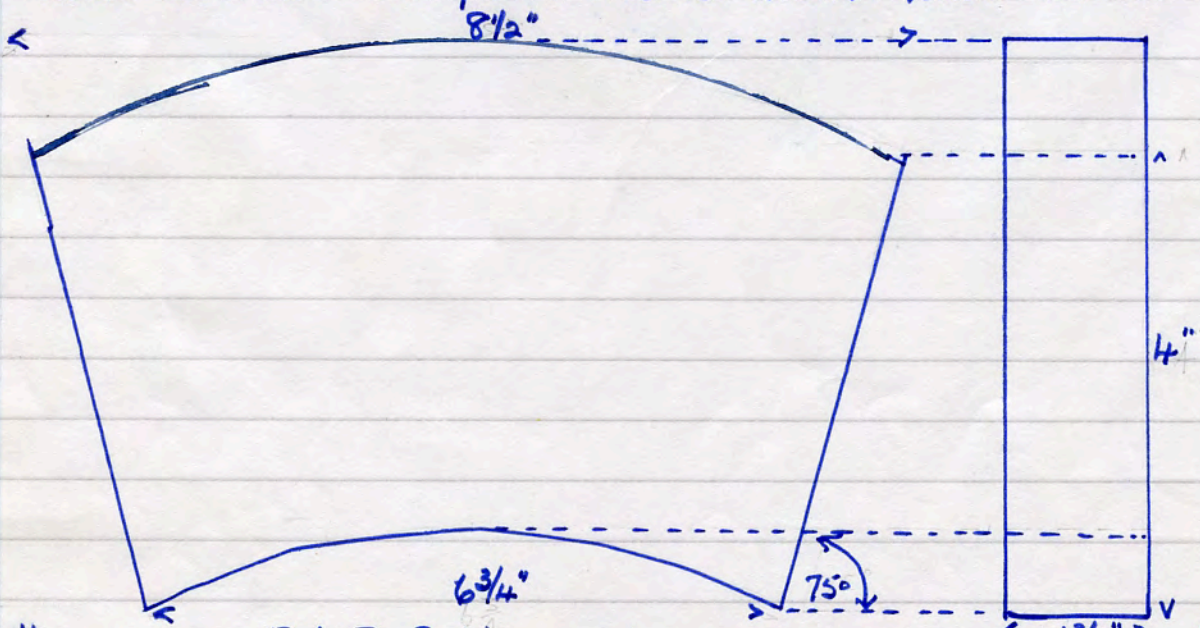

No name 24 R BH red.
all edges dressed. Accpton Mori dem. site 17. 8. '90

3 1/2 lbs.

5001

No name 852 V9 red 2 edges grooved 2cms X 1cm deep.
all edges chamfered to form V joint

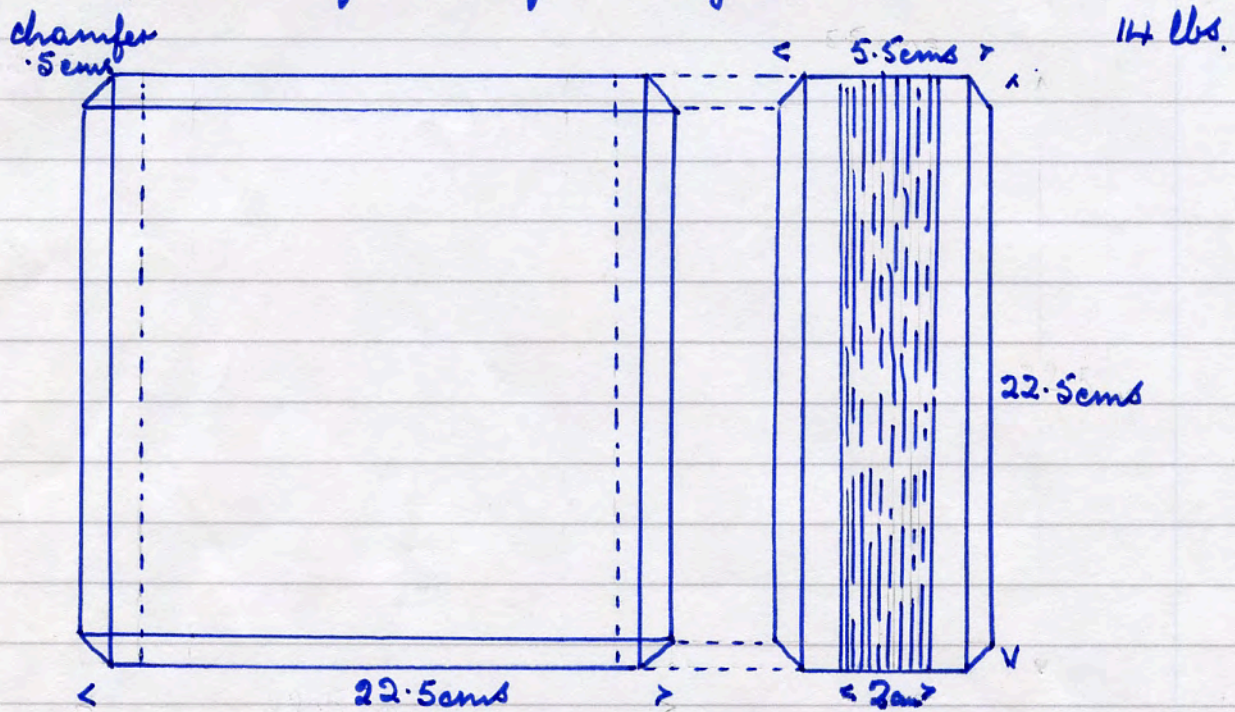

No name 43 N 722 X red. moulder's mark JI
each end dressed T.C.

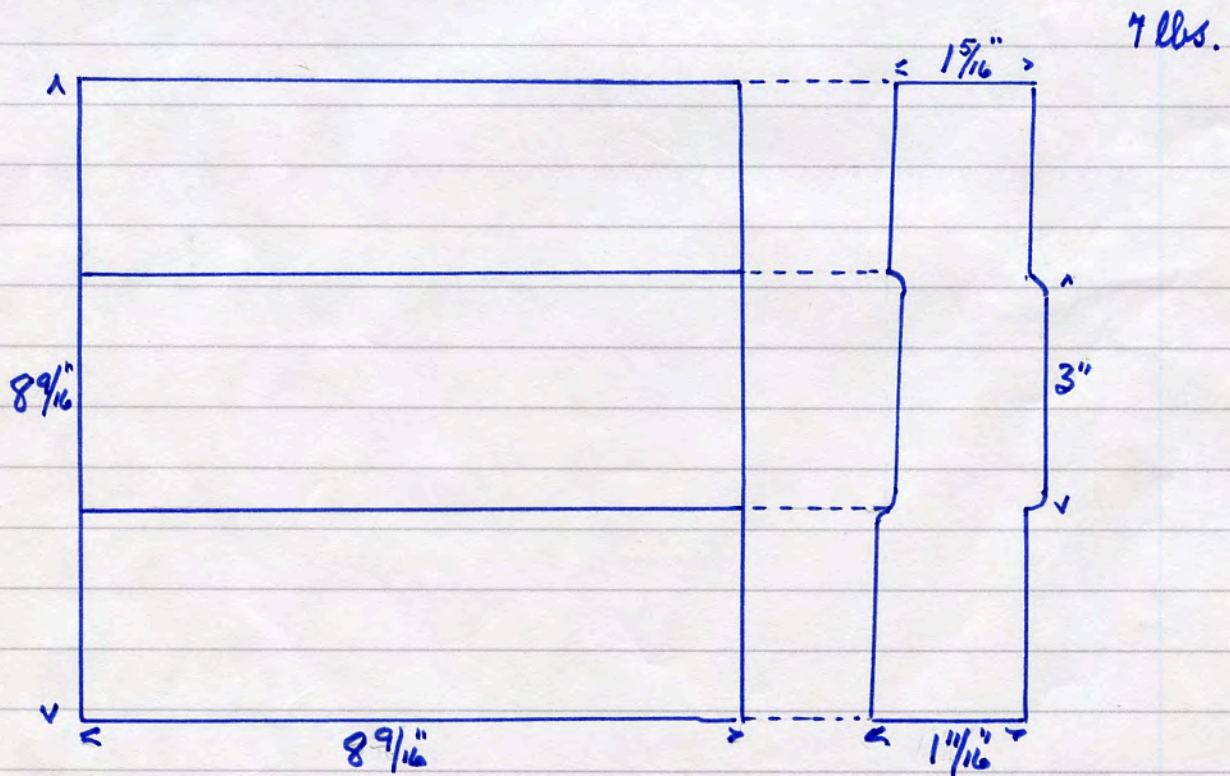

Both above - Accpton Mori dem. site 17. 8. '90

No name 43 N 722 Y red. moulder's marks 11
each end dressed T.C.

5004

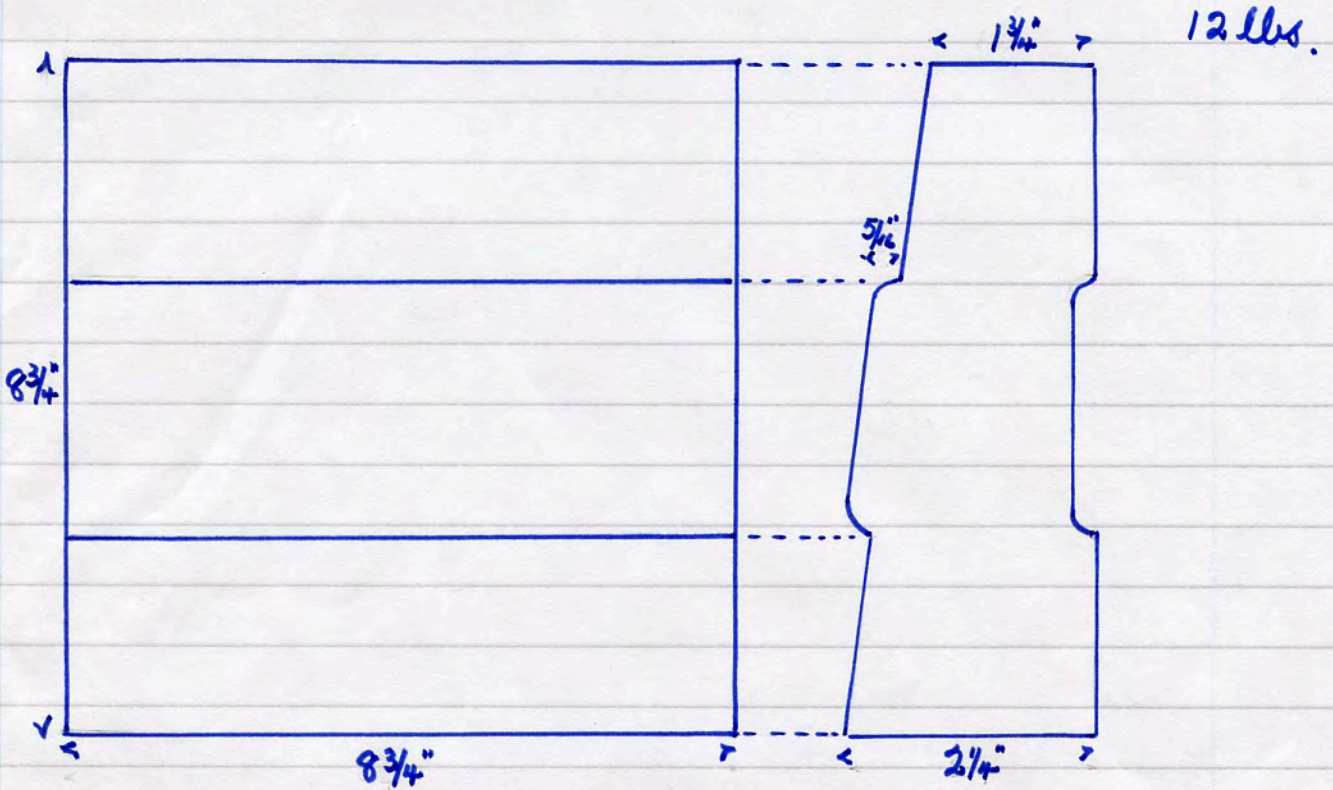

No name 167 W red 2 sides + face side dressed T.C.

5005

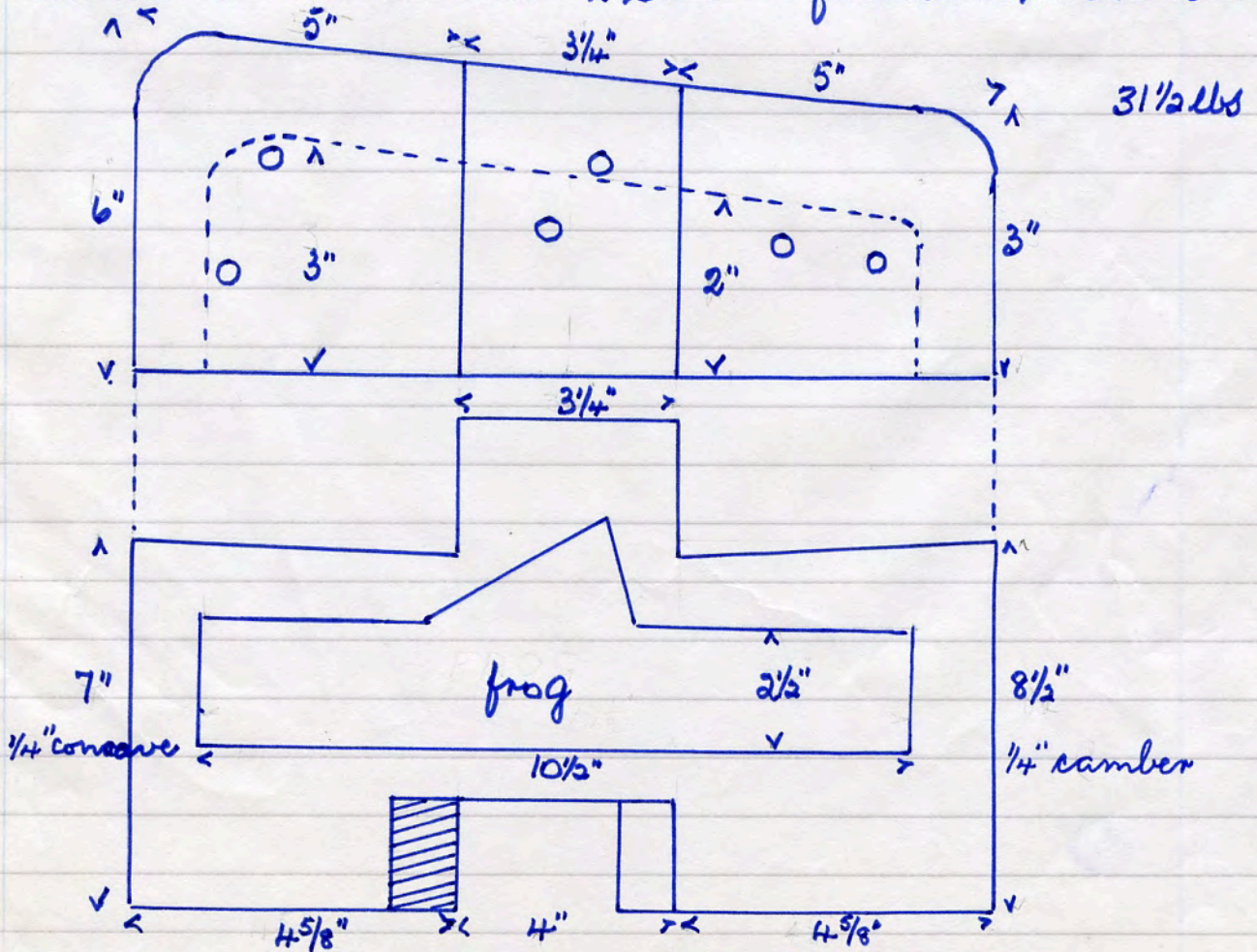

Both above - Acc/ton Mori dem. site 17. 8. '90

No name 410Z red T.C. H vertical edges dressed T.C.

42 lbs

5006

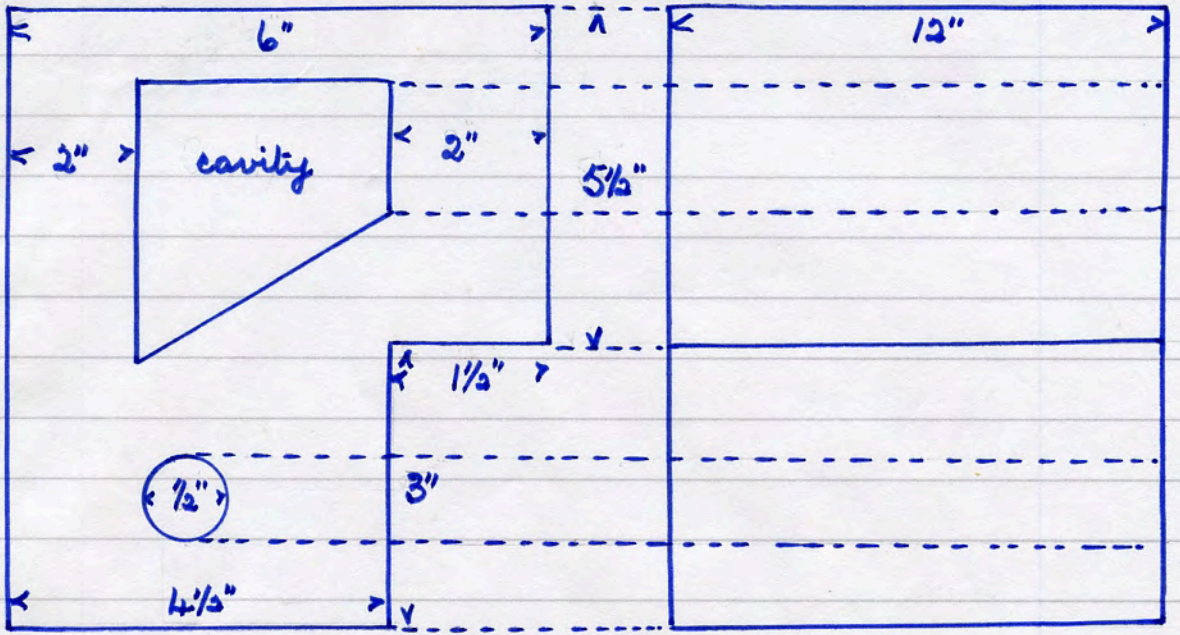

No name, no number. red T.C. 42 lbs

5007

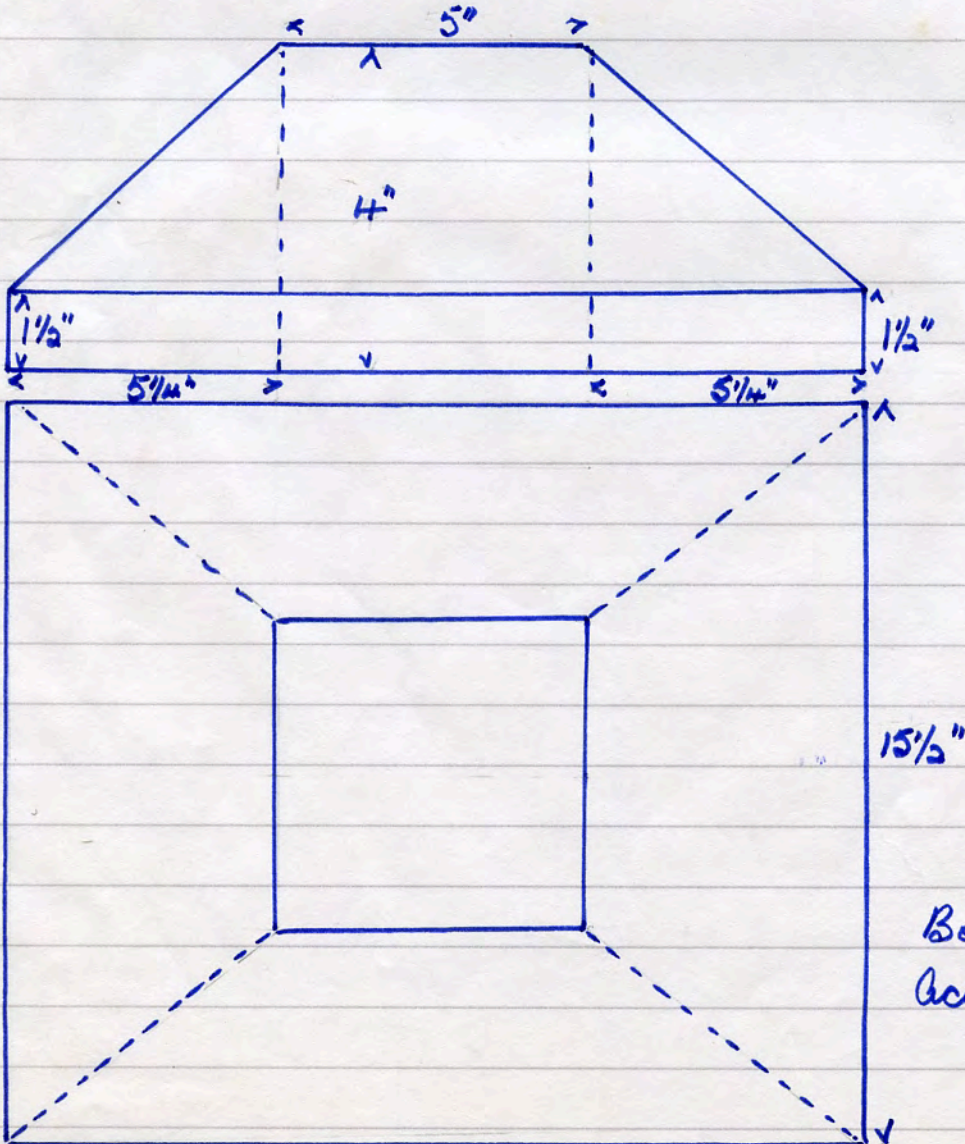

Both above -
Acc't on ^{now} Clem. site
17. 8. '90

No name 990U Bowland Brown.

2 edges + 2 ends dressed with T.C.

7 1/2 lbs.

5008

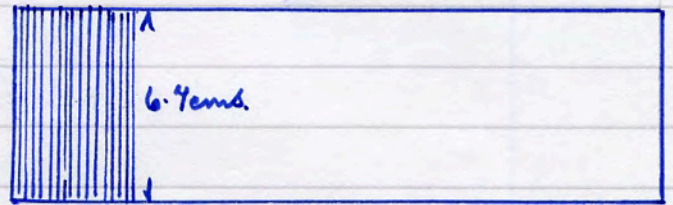
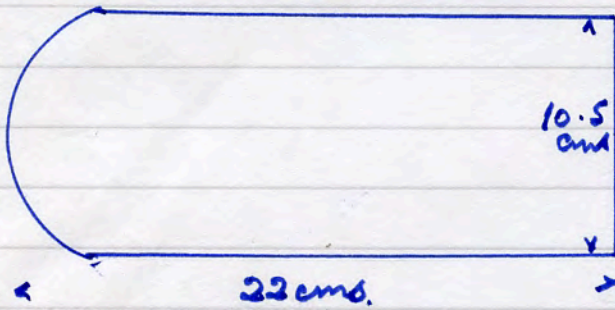

ENGINEERING NORI red gauged brick from underground heating passages, single panel obr. plain rev. letters incised.

9 lbs.

5009

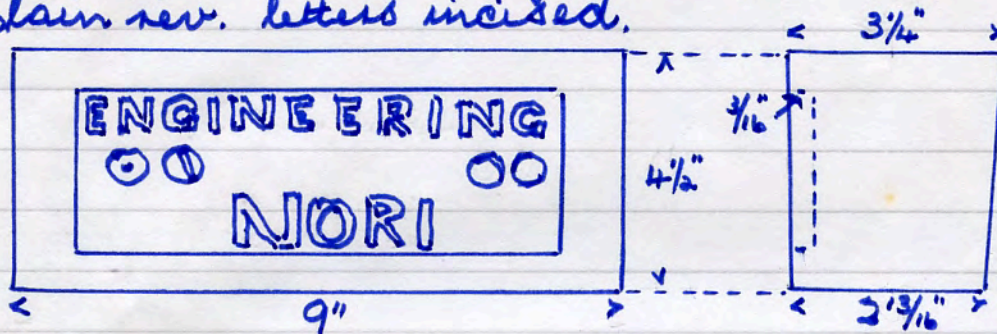

G CLARK RISHTON fine clay brick ex kilns at Accrington Brick & Tile Co. Ltd. single panel each side letters incised.

8 lbs

5010

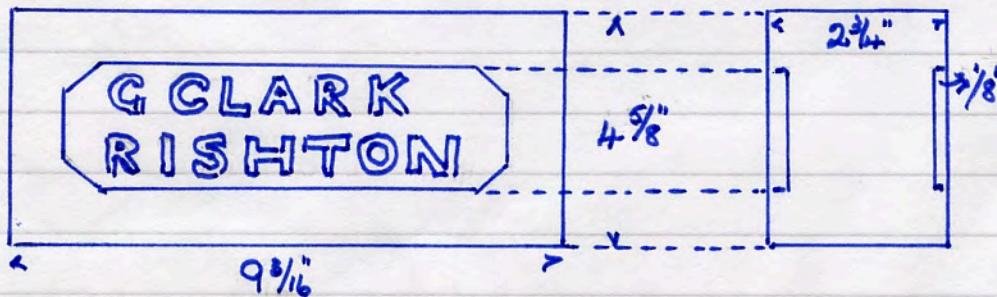

All above - Accrington Mani dem. site 17. 8. '90

GIBBONS (DUDLEY) LTD SPECIAL fire clay A stamped on side

5011

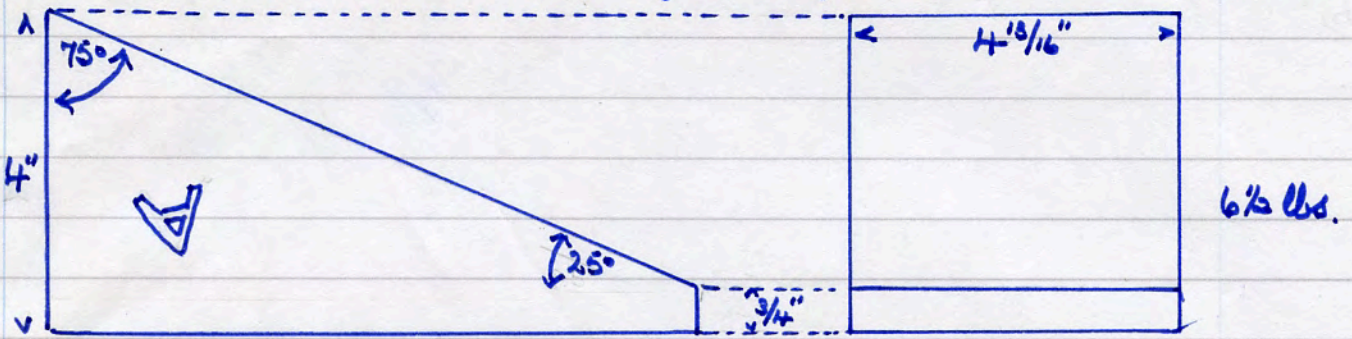

5012

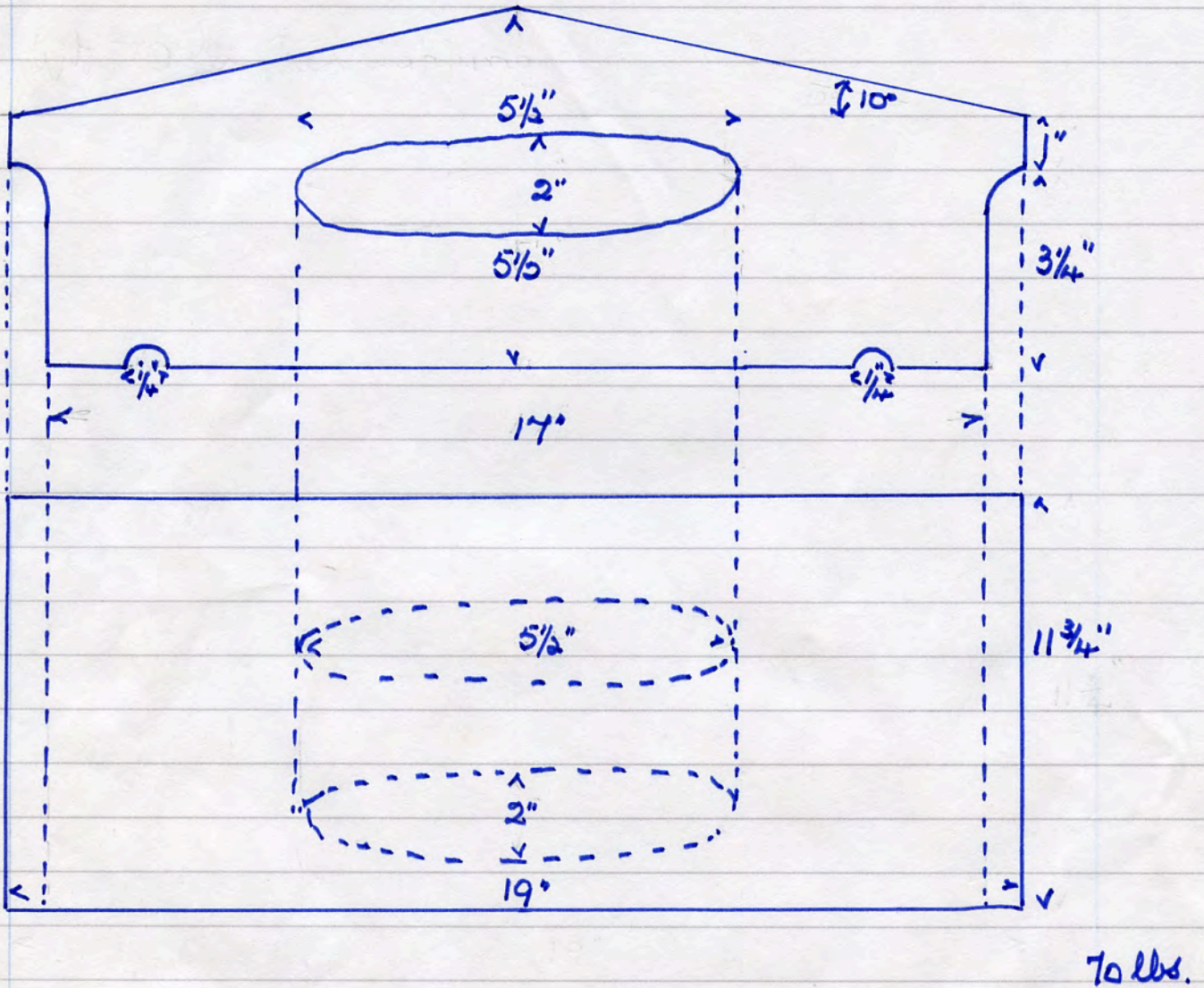

No name 334-14 moulder's mark JG
red wall cap. all faces dressed T.C.

Both above - Acception Mani dem. site 17. 8. 90

No name 715 U Bowland Brown return
rustic or wire run

5013

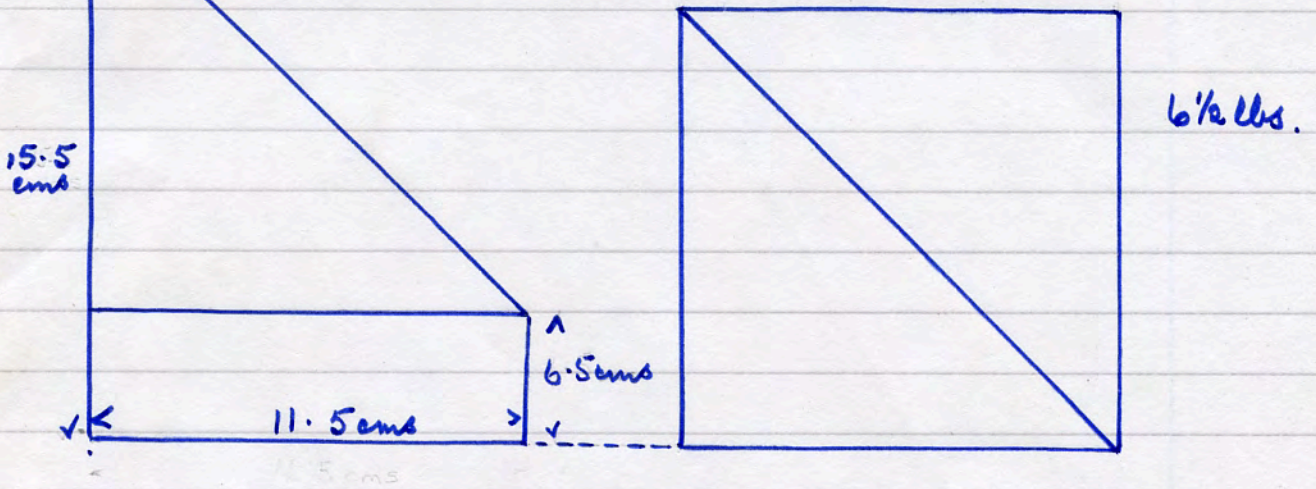

314 TS red

5014

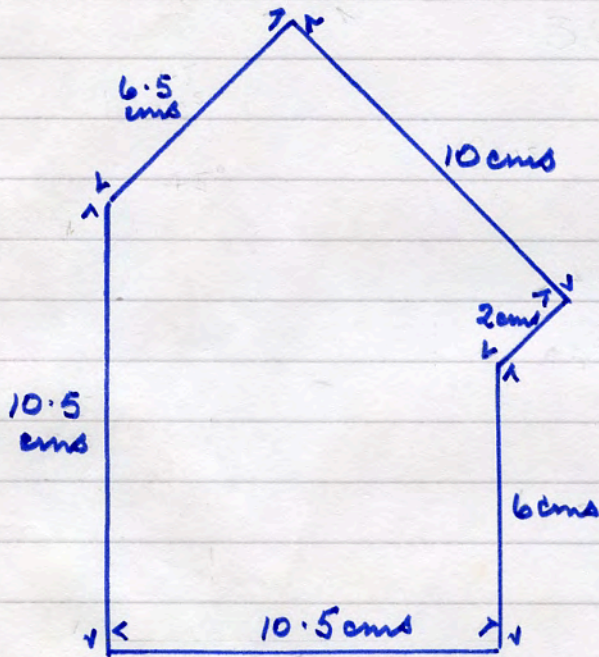

No name 314 TS red
2 face edges dressed T.C.

length 21.5 cms. 14 lbs.

Both above - Acpton Mori dem. site 14. 8. '90

5015

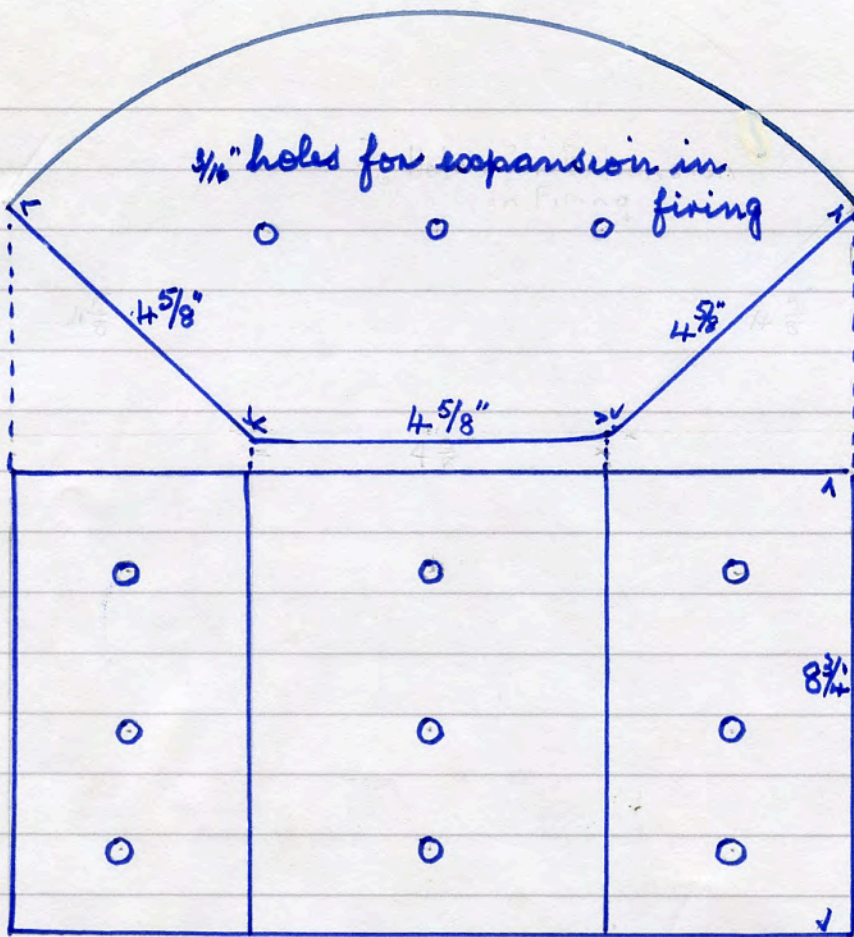

No name 177 U red. moulder's mark JC
 circular face dressed T.C. 28 lbs.

5016

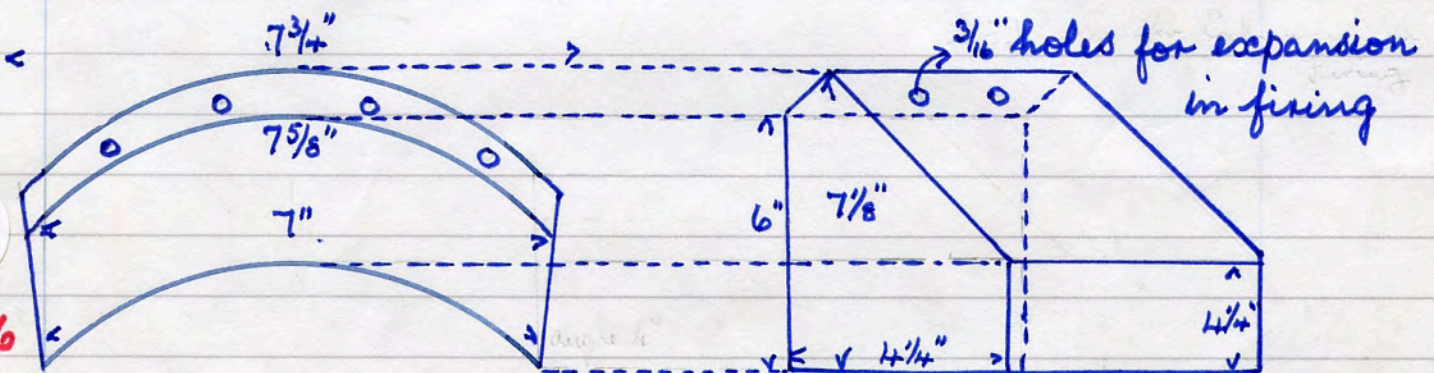

No name 51 R 8 red. pitched face + vertical surfaces
 14 lbs. dressed T.C.

Both above - Acc/ton Mori dem. site 18. 8. '90

5017

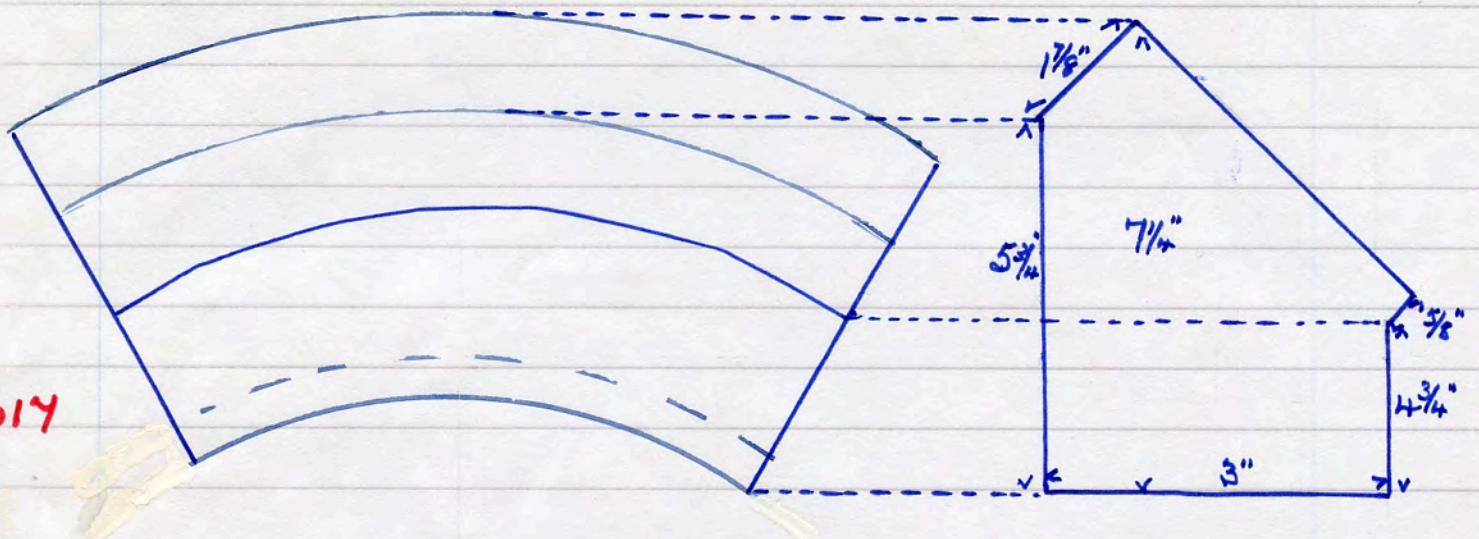

No name 75 K 9 red. internal face and part of
 reb. only, dressed T.C. 14 lbs.
 29 x 3/16" diam. holes in reb. (to assist burning)

5025

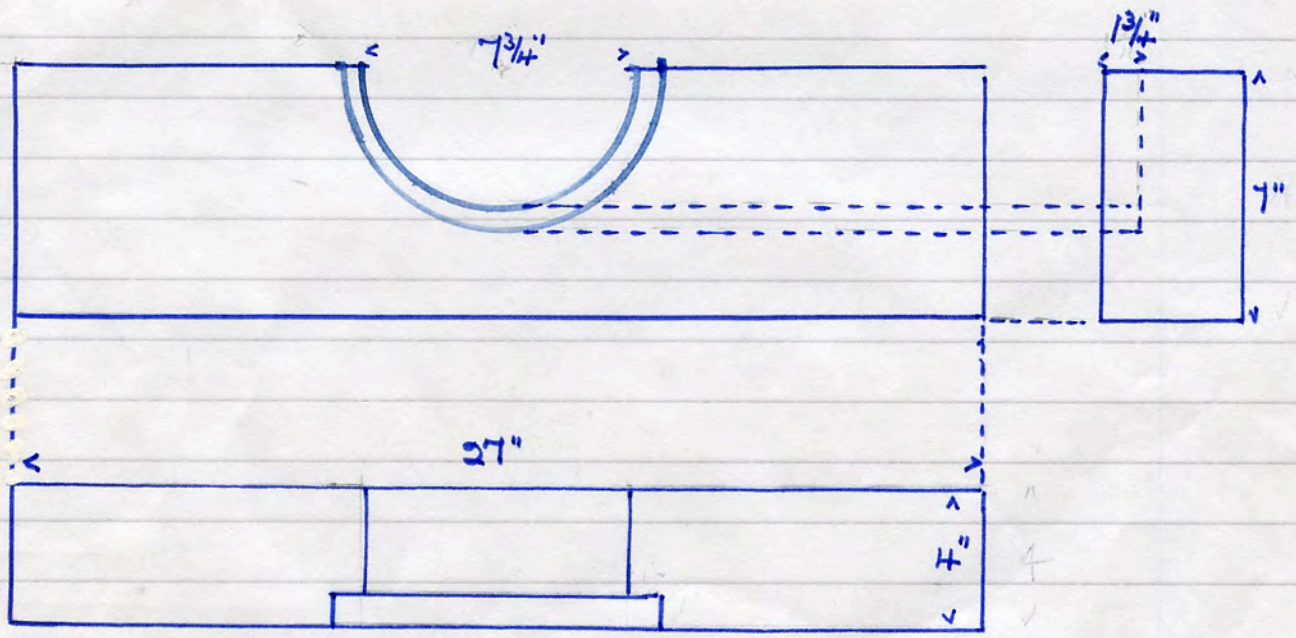

No name 61 K 255 red. T.C. dressed all over. 42 lbs.

Both above - location Mori dem. site 18. 8. '90

No name 832U red. dressed with T.C on top surface and in spitter

5026

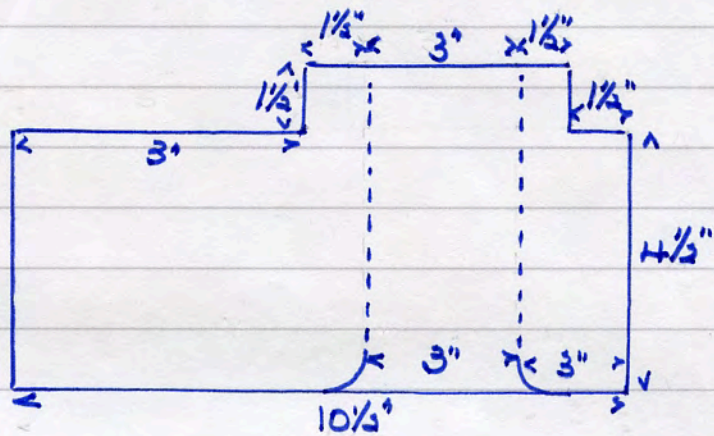
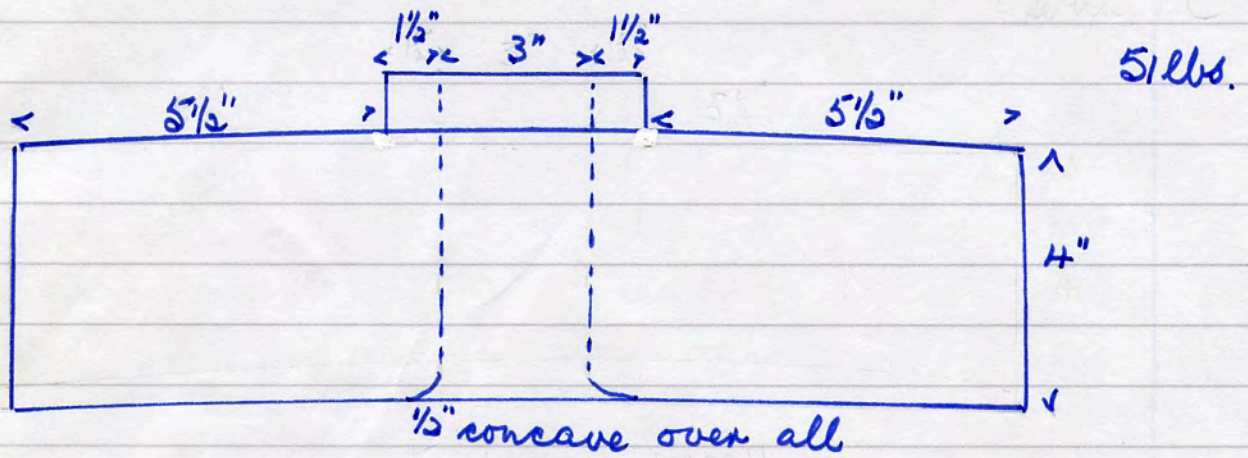

No name. 942V red. dressed T.C 2 face edges and 84 lbs 2 x 1" diam. perfs. 1 face side

5027

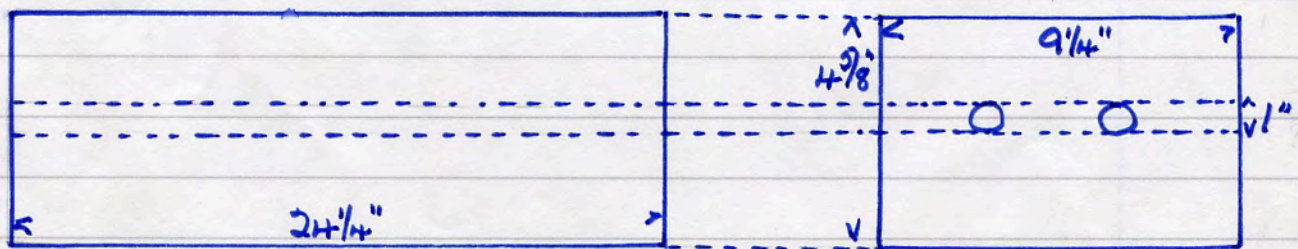

No name H 250 red 2 x 1" diam. perfs. 63 lbs.

5028

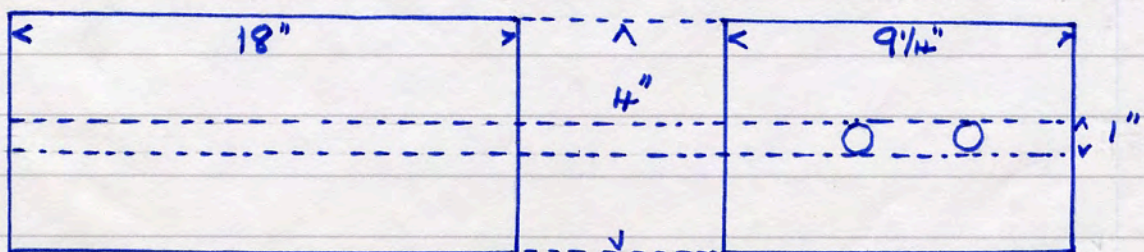

All above - Accipiter Mexi dem. site 18. 8. '90

No name 29 G 24 red. internal face & top edge T.C.

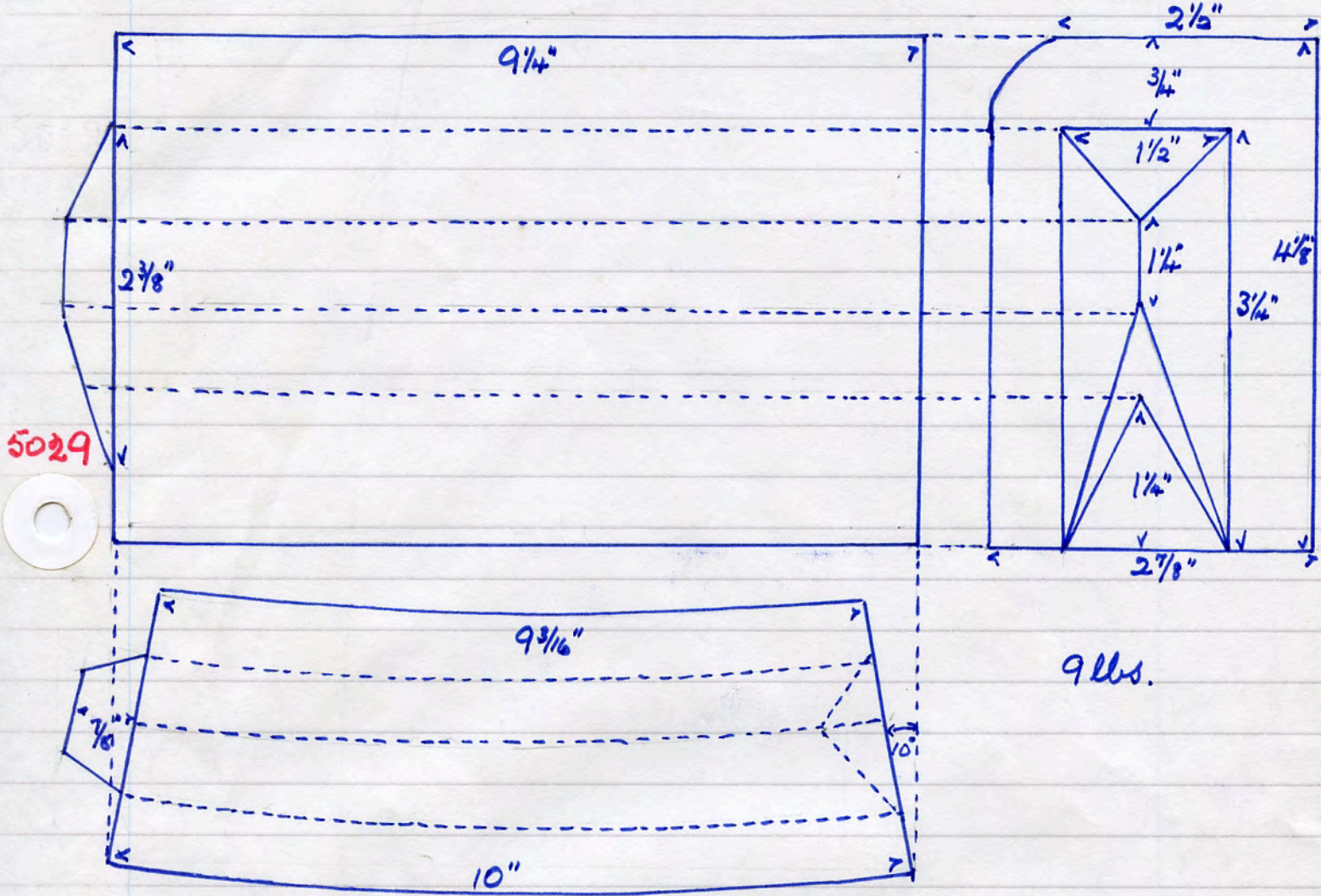

9 lbs.

segment, top brick of a cylindrical vessel.

5030

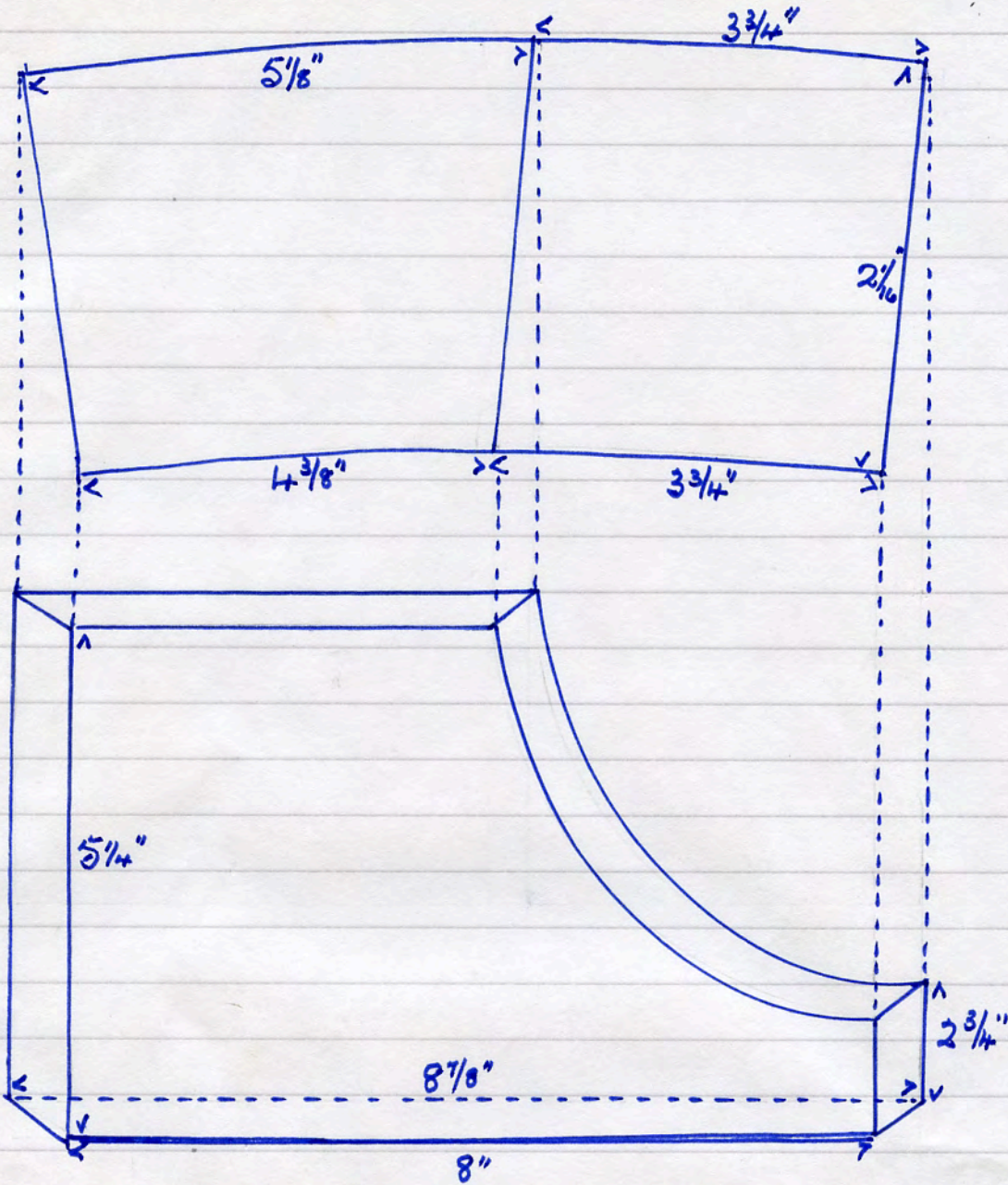

No name 27 G 116 red. no T.C. dressing 7 lbs

Gepton Mori dem. site 19. 8. '90

5031

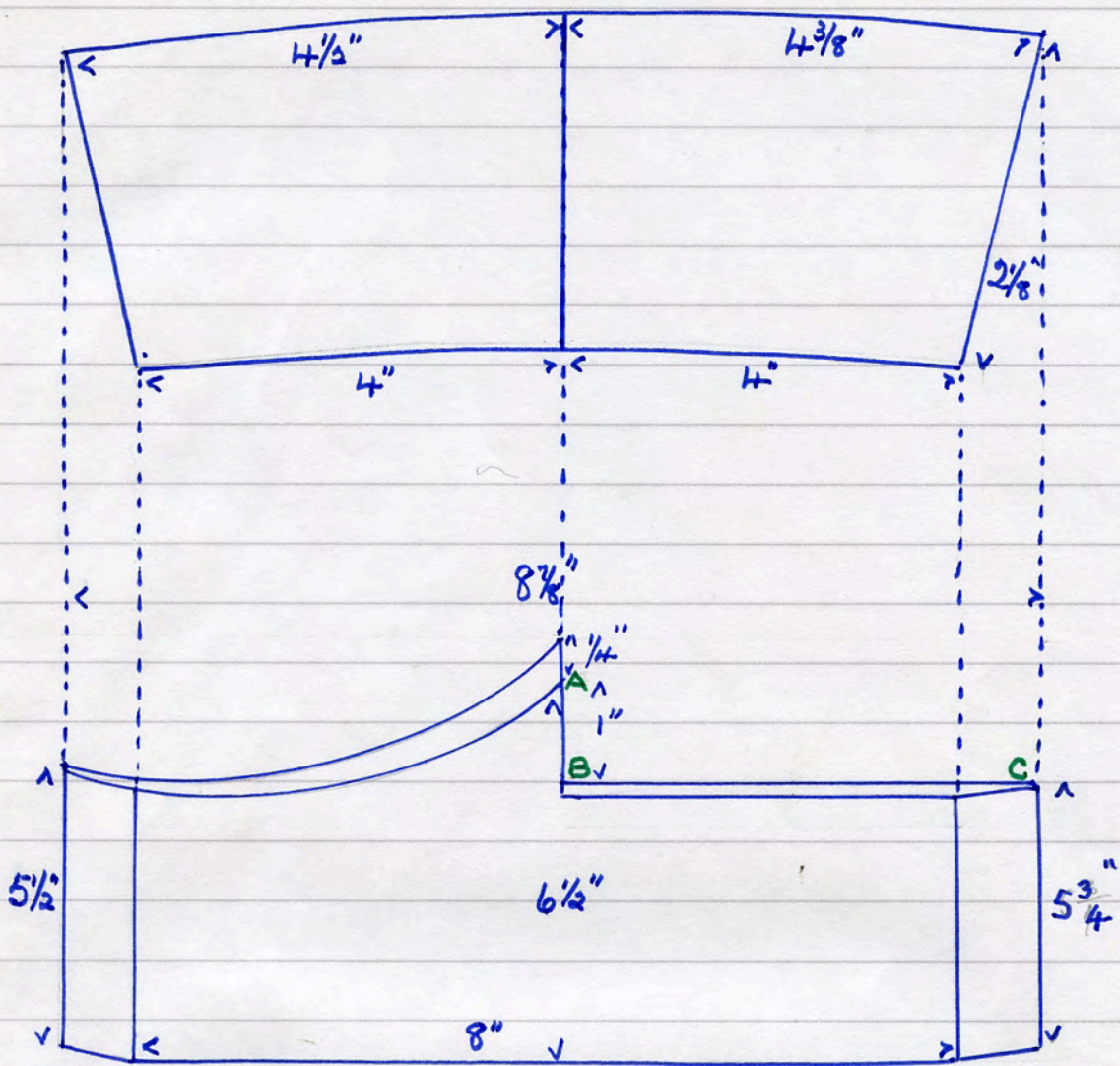

No name 27 G 65 red. dressed T.C only on ABC. 8 1/2 lbs

Ashton Mori dem. site 19. 8. '90

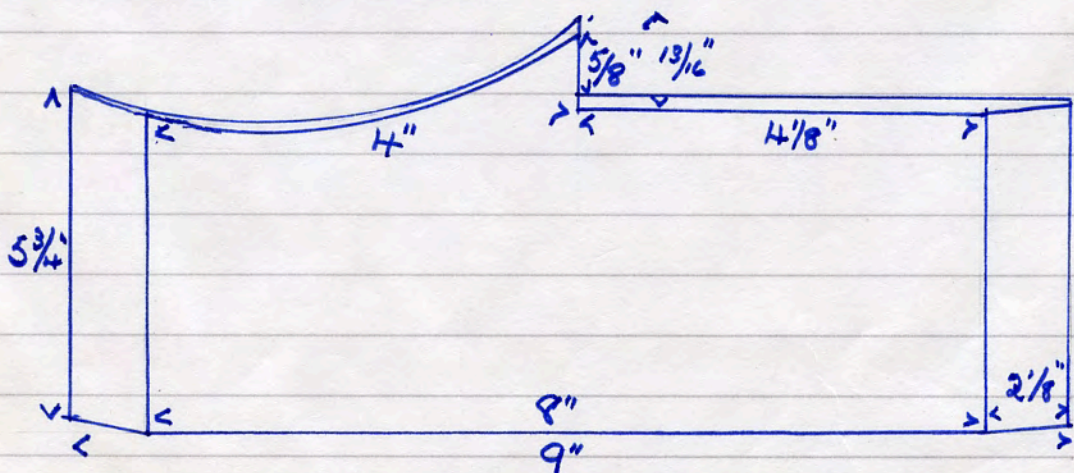

5032

9 lbs.

No name 27 G 72 red. no T.C. dressing
The plan of this is exactly as 5031.

No name 27 G 43 red. top & bottom edges dressed T.C.

5033

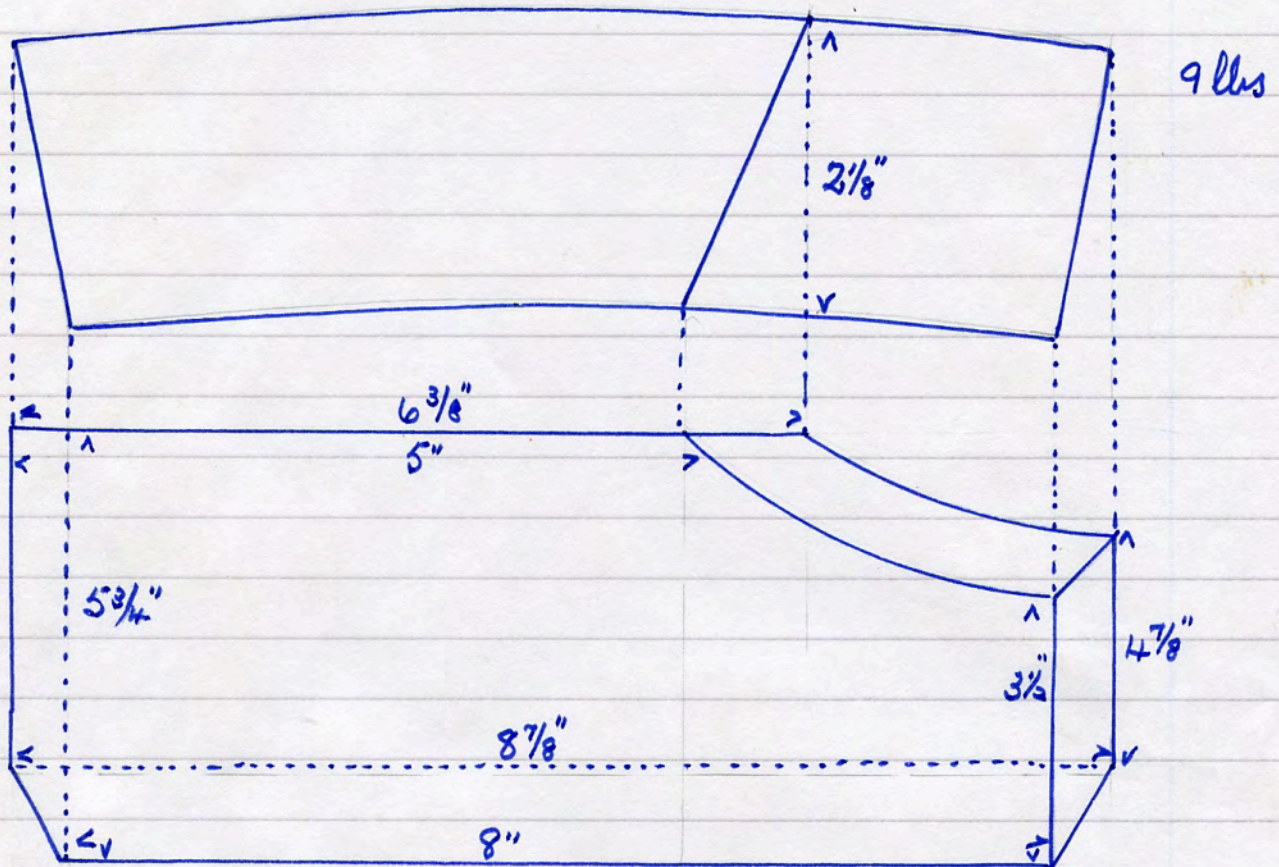

Acpton Mari dem. site 19. 8. '90

No name 27 G 99 red. internal face + curved area dressed T.C.

5034

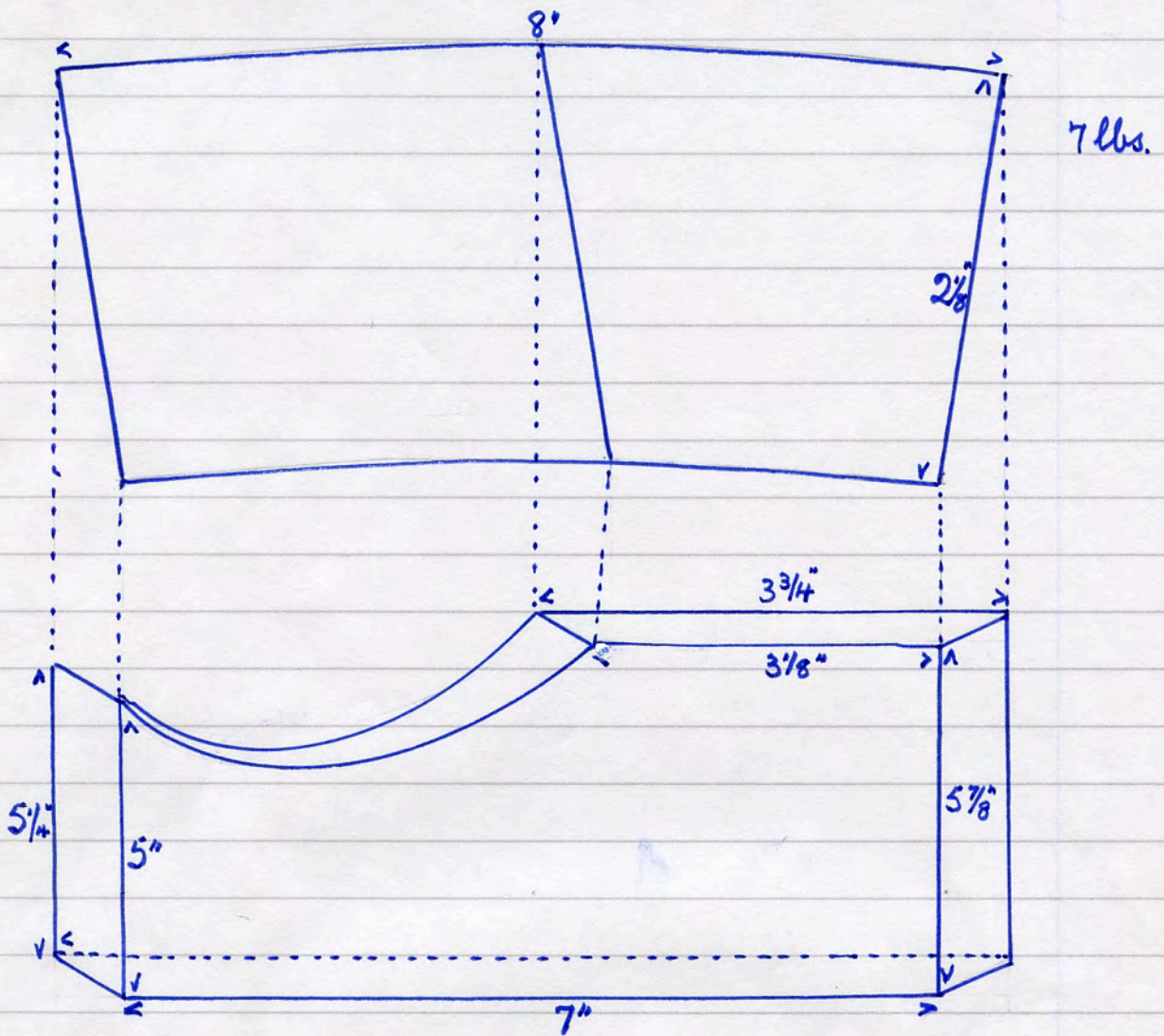

No name 27 G 61 red. inside of internal curve T.C

5035

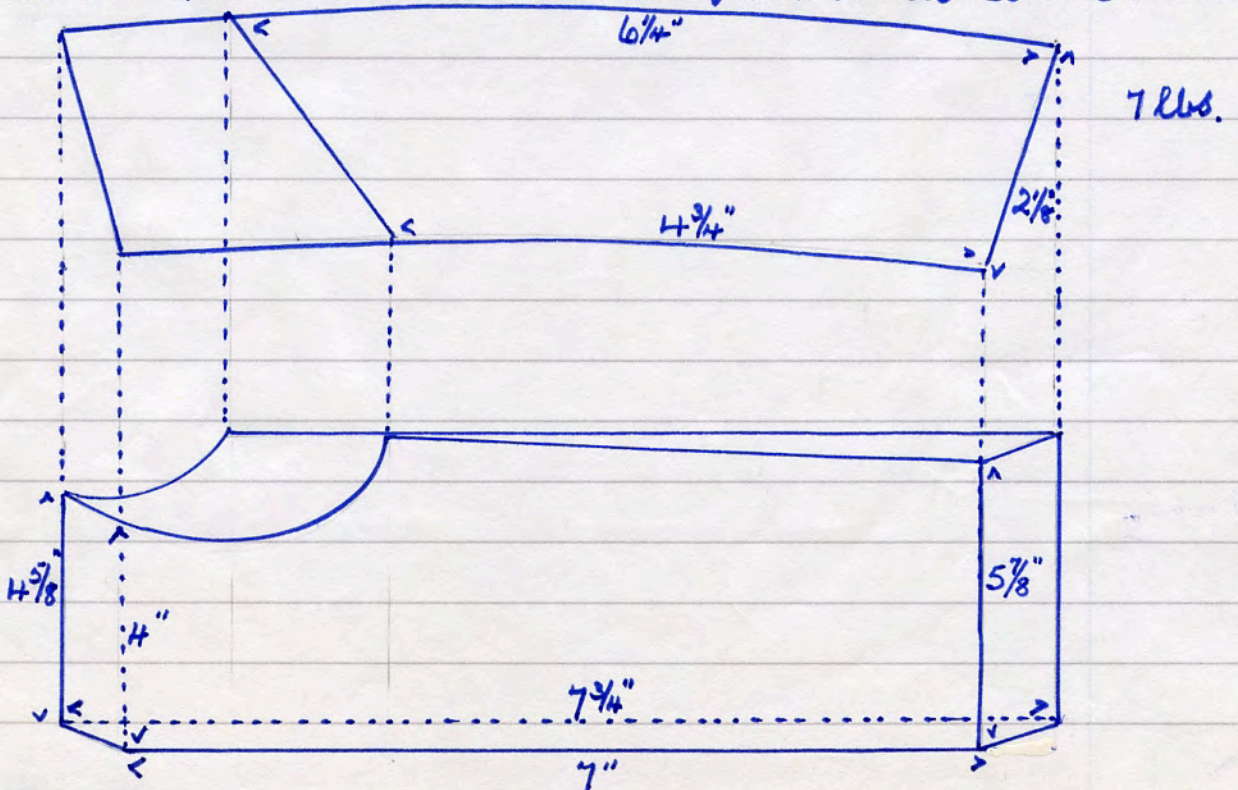

No name 27 G 105 red. T.C. dressed on internal face and base.

5036

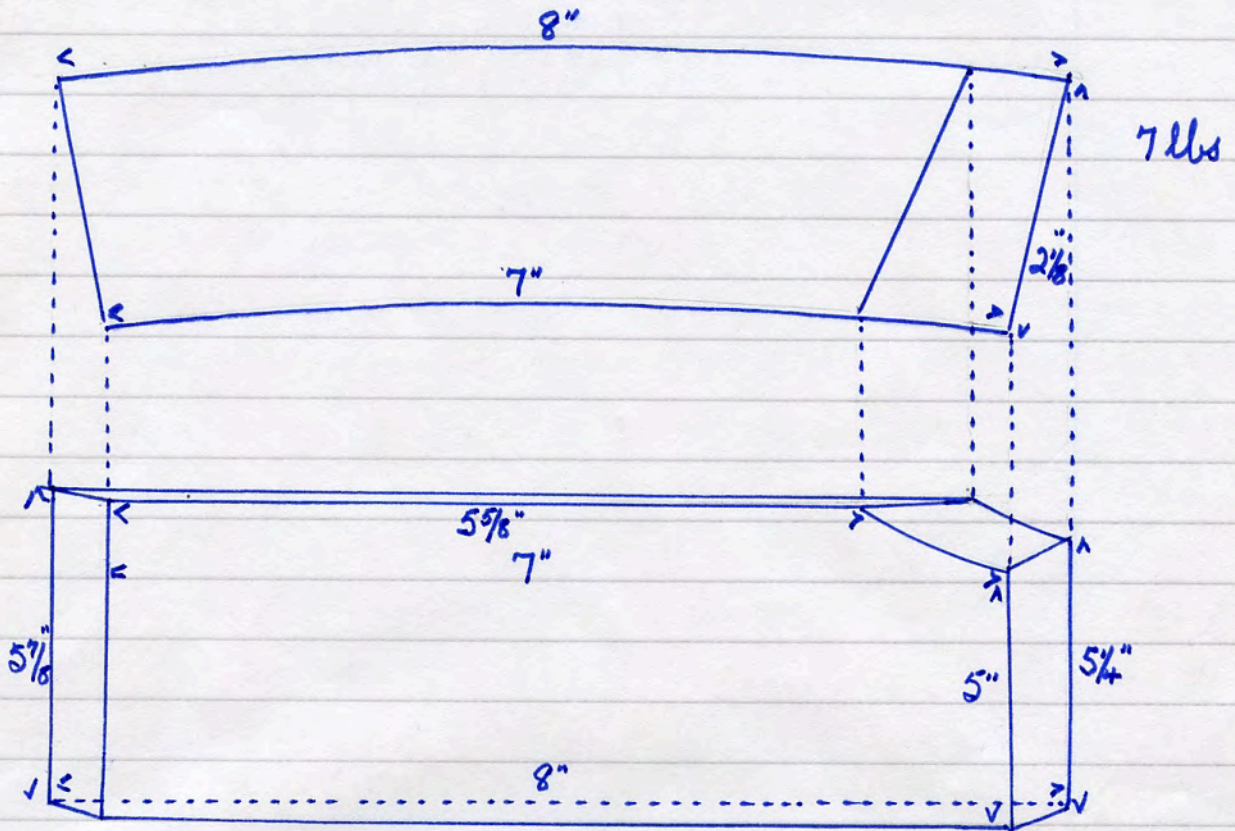

No name 27 G 109 red. internal face only dressed T.C.

5037

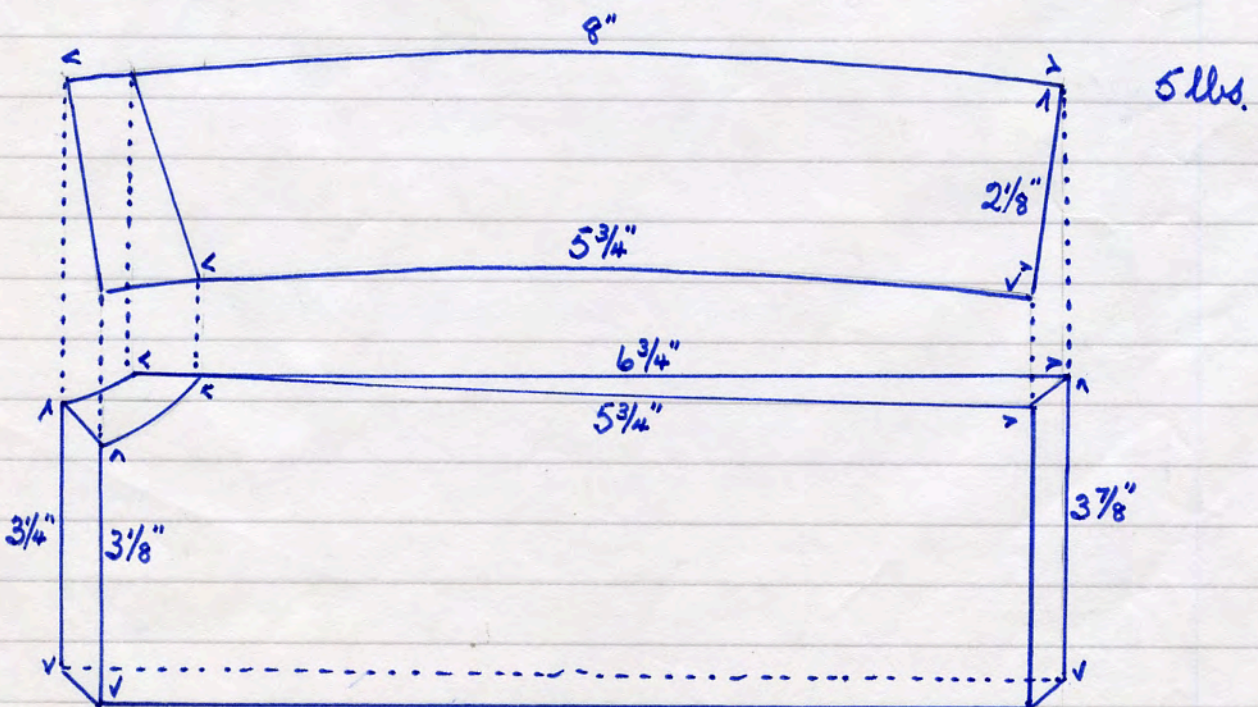

Both above. Accpton Mexi dem site 19. 8. '90

No name 27 G 120 red. internal faces dressed T.C. 6 1/2 lbs

5038

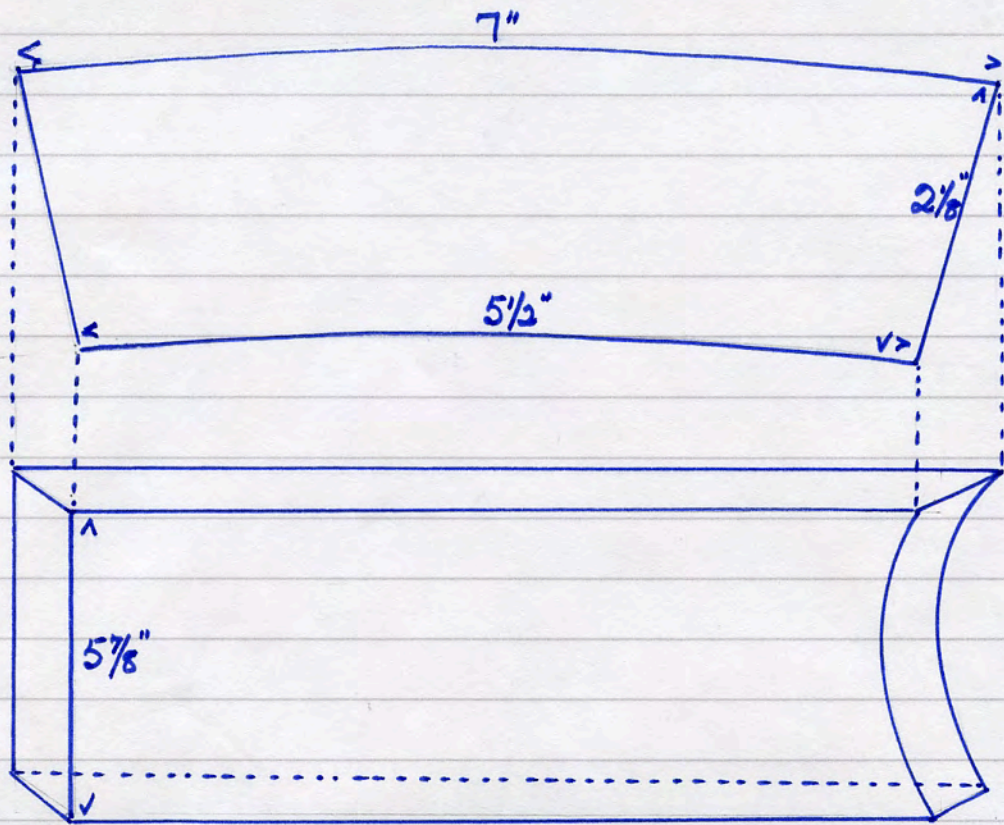

5039

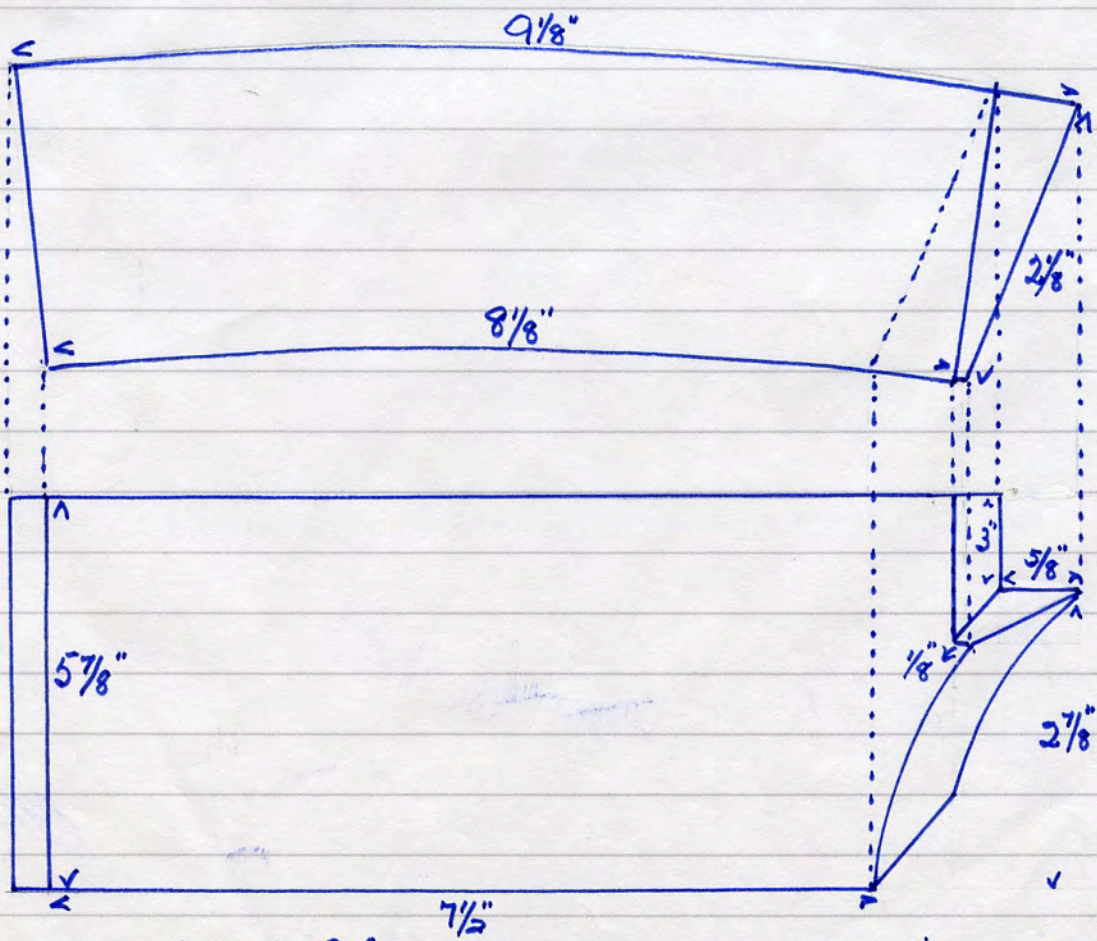

No name 27 G 94 red. no T.C. dressing 8 1/2 lbs

Both above - Acftentoni dem. site. 19. 8. '90

5040

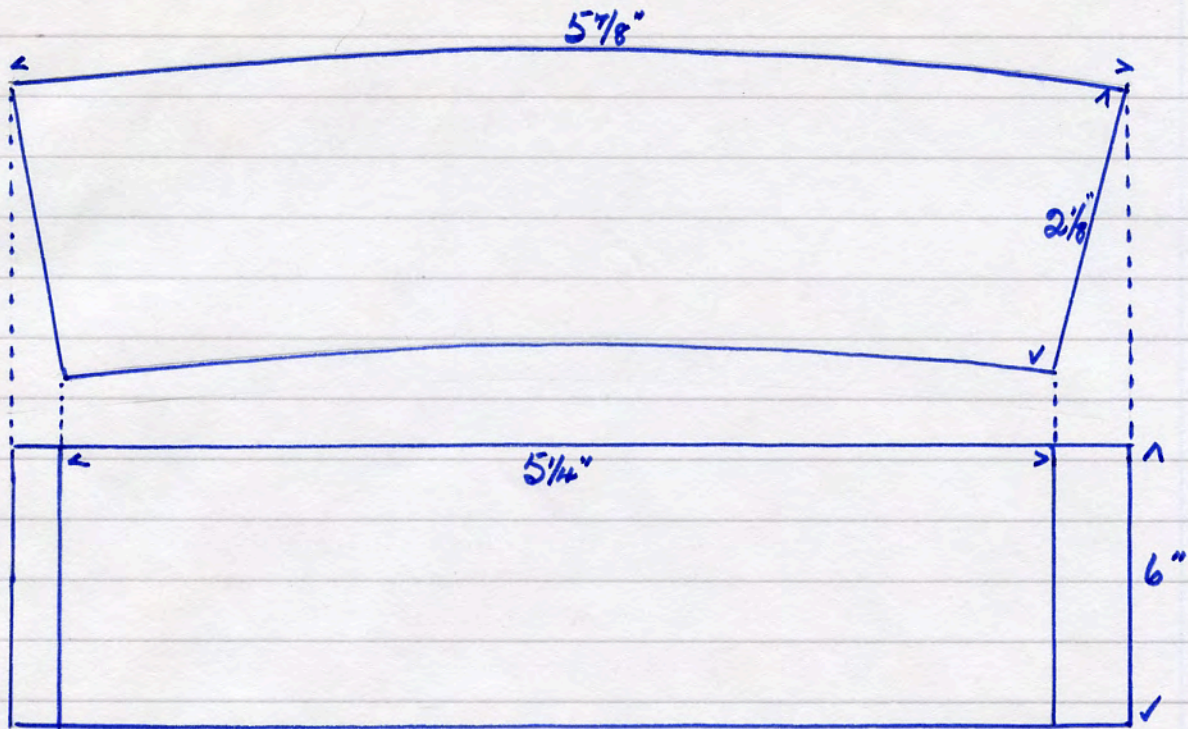

No name 27G 40X red. no T.C dressing 6 lbs

5041

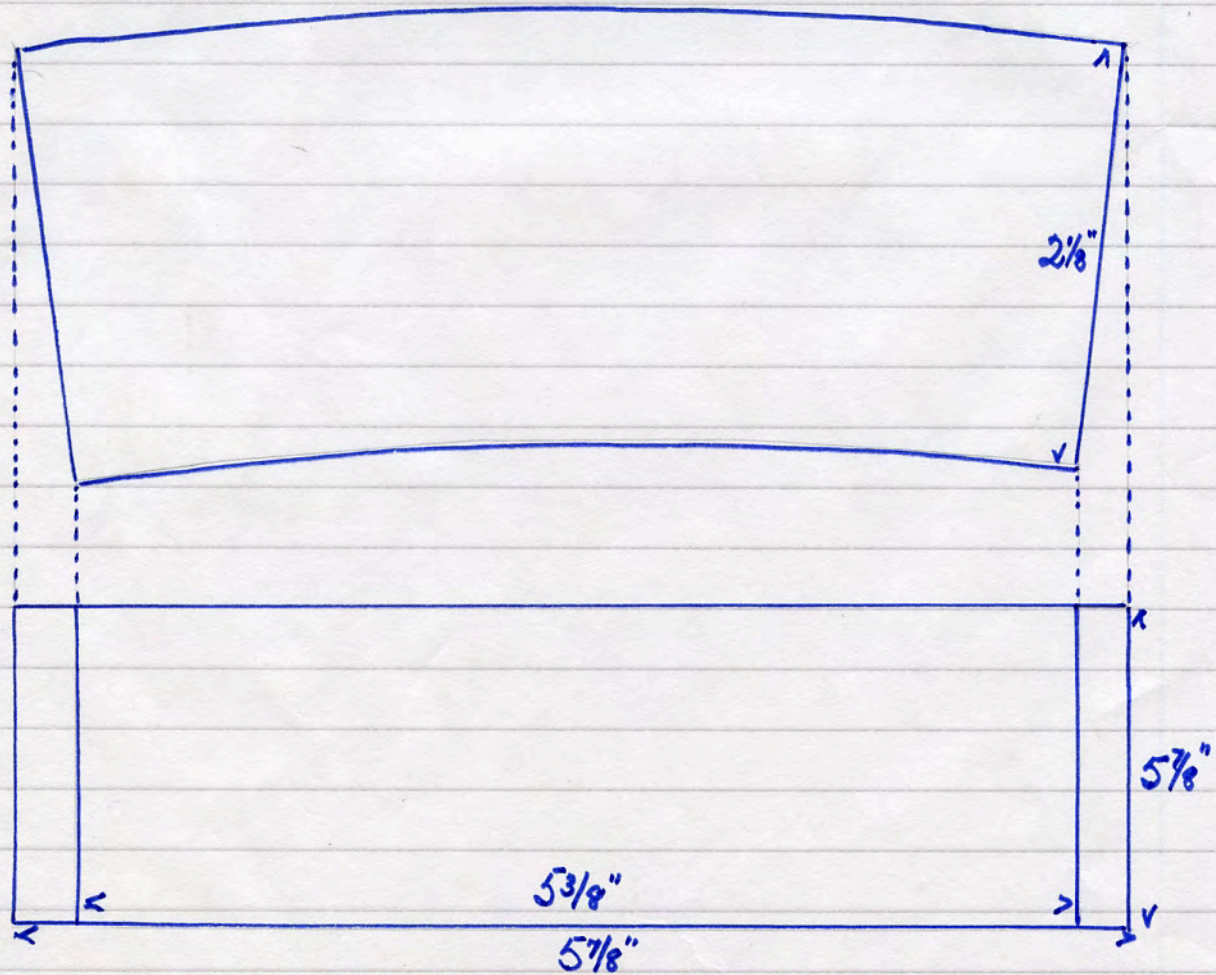

No name 27 G 39X red. no T.C. dressing. 6 1/4 lbs.
Both above - Acpton Mari dem. site 19. 8. '90

5042

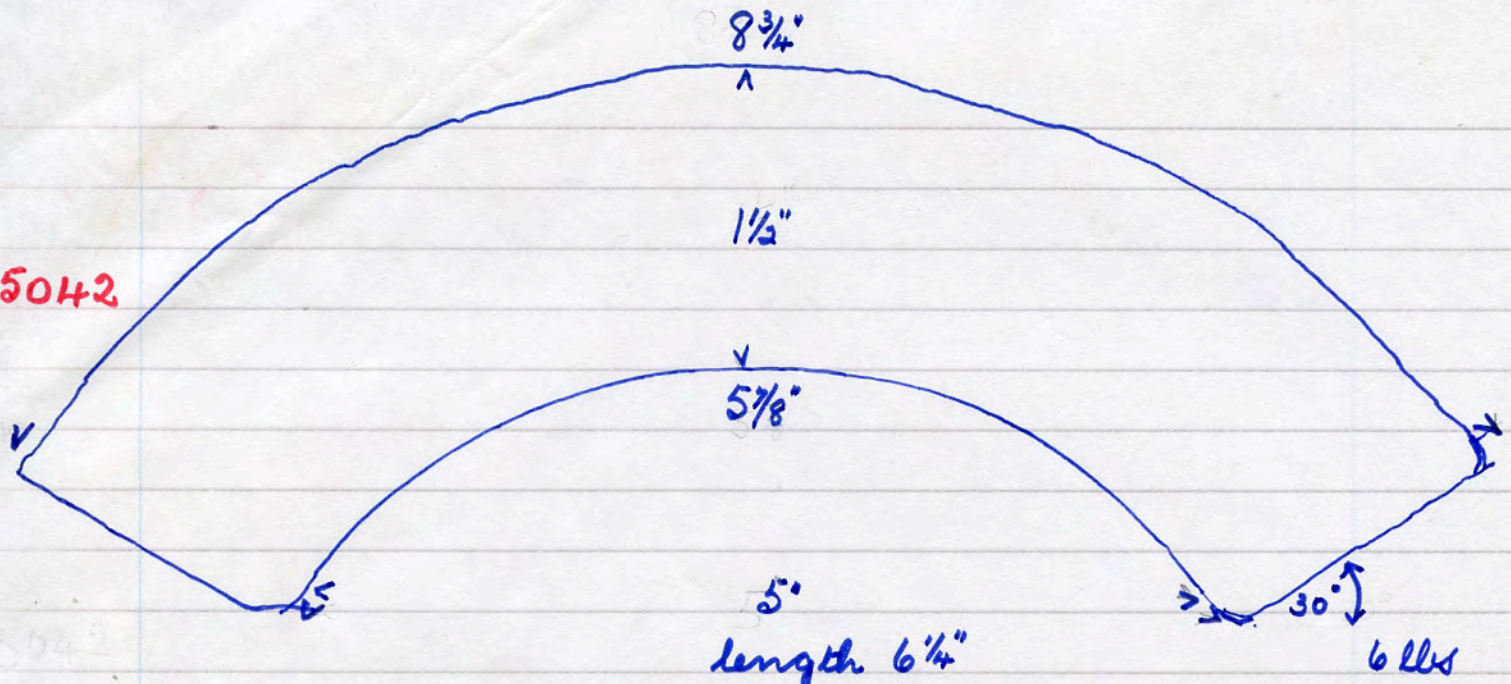

No name 50 G 29 red. internal surface + base T.C. 6 lbs

5043

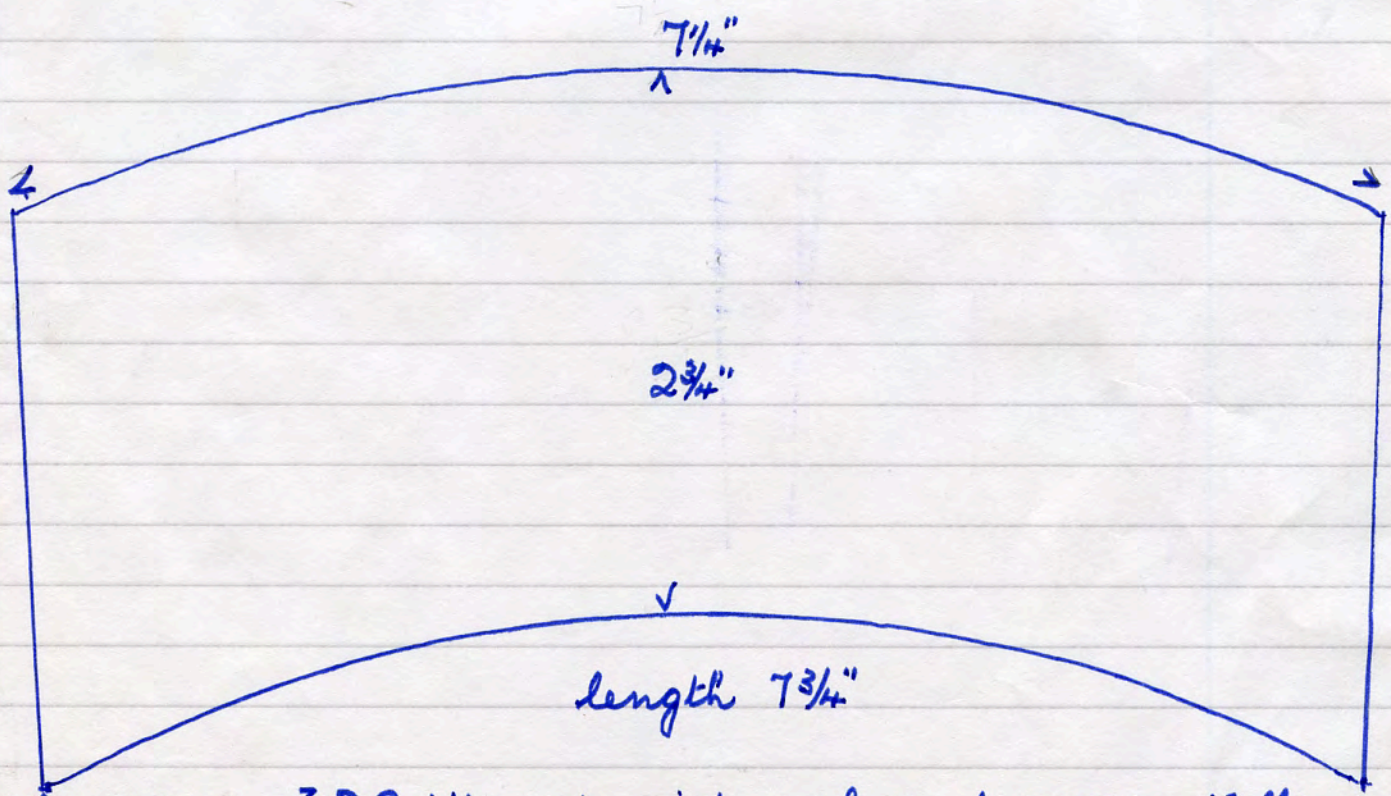

No name 329 U1 red. internal surface T.C. 13 lbs

Both above - Acqten Mari dem. site 19. 8. '90

No name 329 U2 red
 internal surface only T.C.
 moulder's mark TH

5044

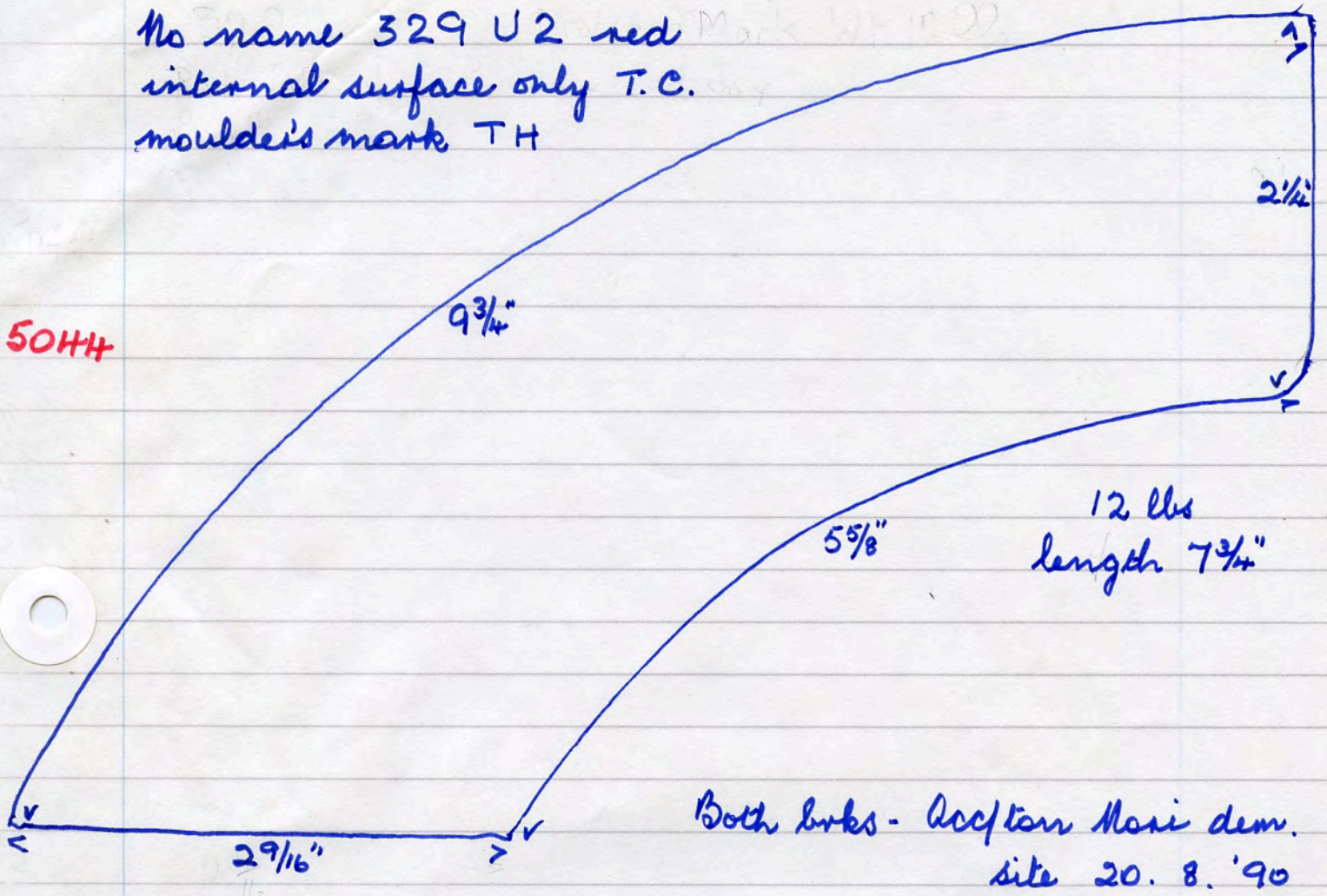

Both sides - Acceptor Masi dem.
 site 20. 8. '90

5045

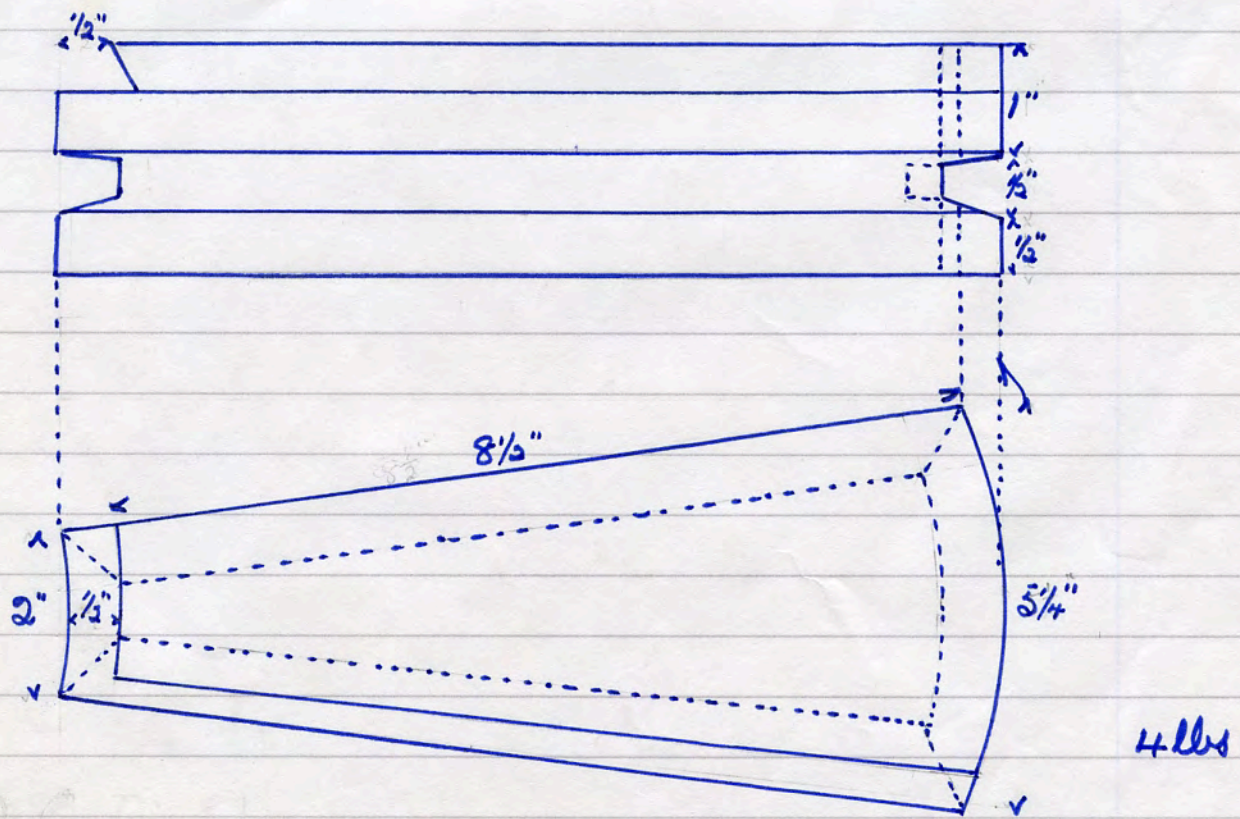

No name 24B2 red. face side only dressed T.C.
 moulder's mark HP

No name 24 B 5. red. face side only dressed T.C.
 moulder's mark HB 11 lbs

5046

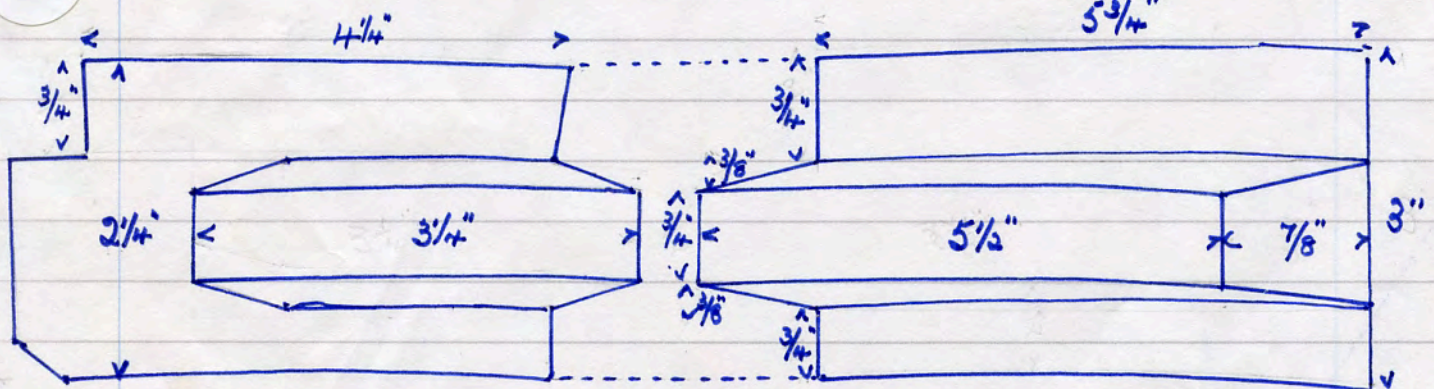
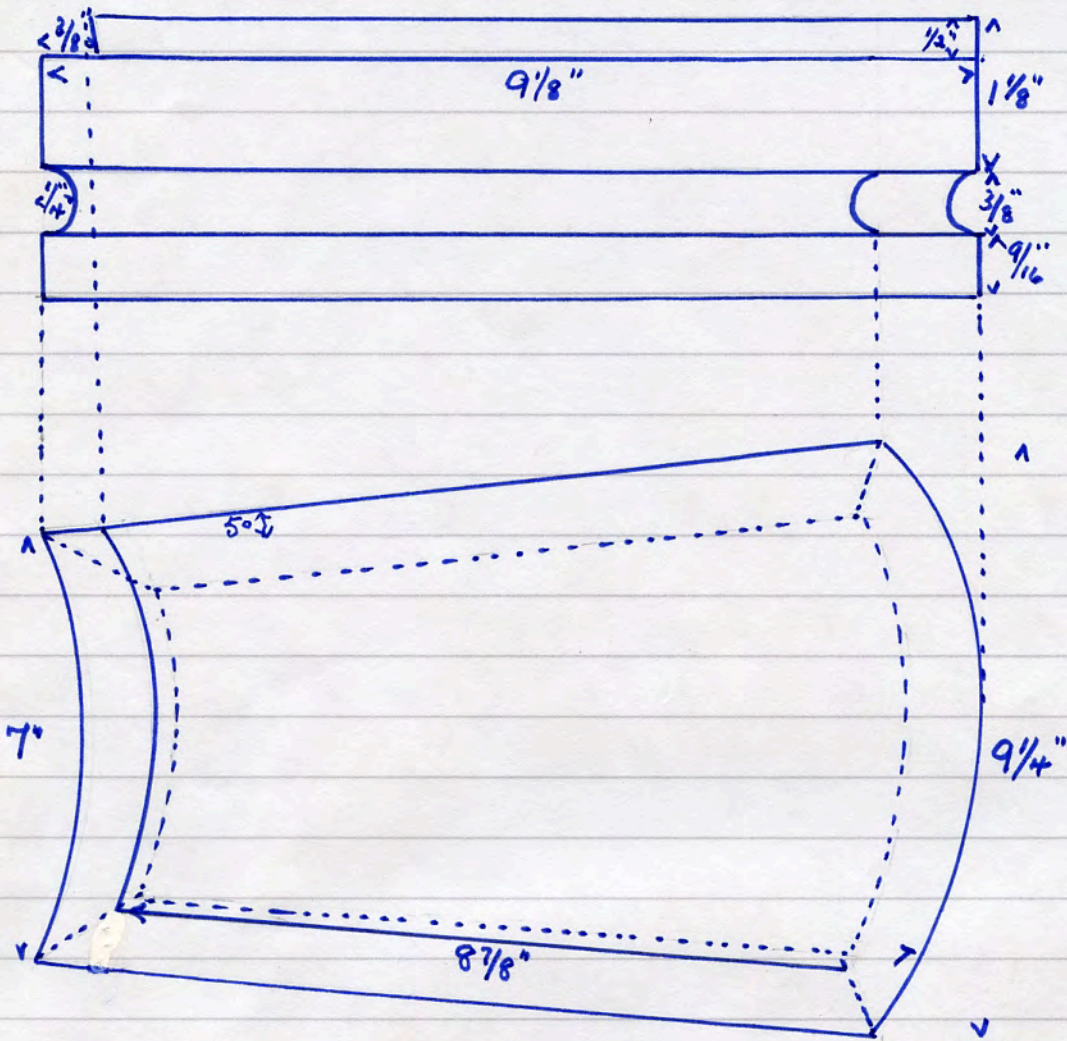

5047 No name 79 F 14 red internal face chamfer + rebates T.C
 number in a panel on rev. dressed.
 5 1/2 lbs

Acc/ton Mori dem. site 20. 8. '90

No name 19 F 13 red. internal faces & top edges dressed T.C.
 follow-on piece to 5047. 5 lbs.

5048

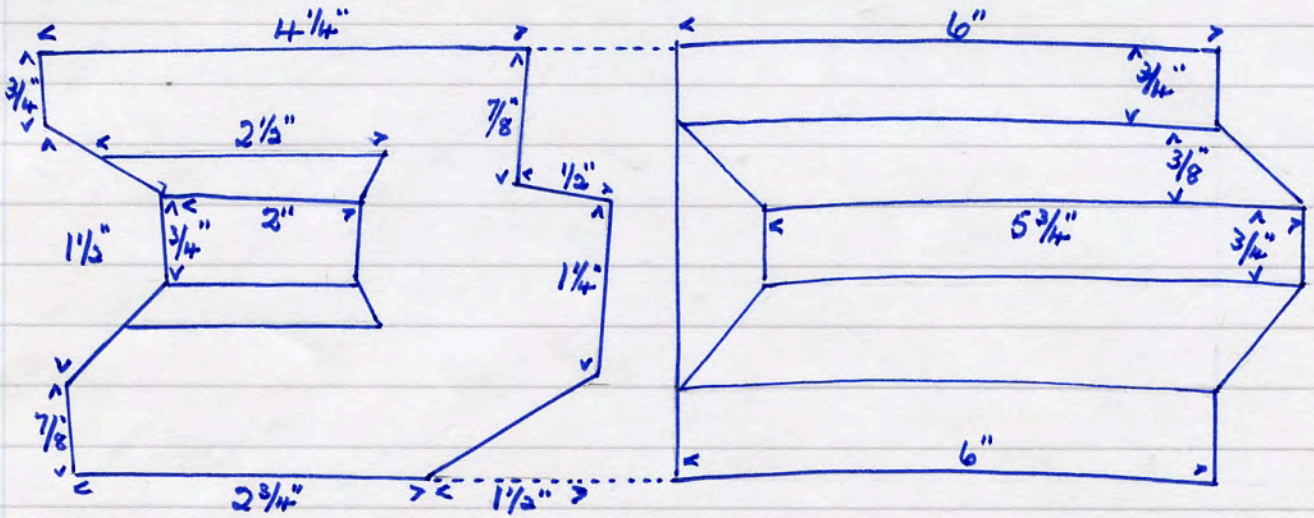

No name 75 NF red. internal face only dressed T.C.
 3 lbs.

5049

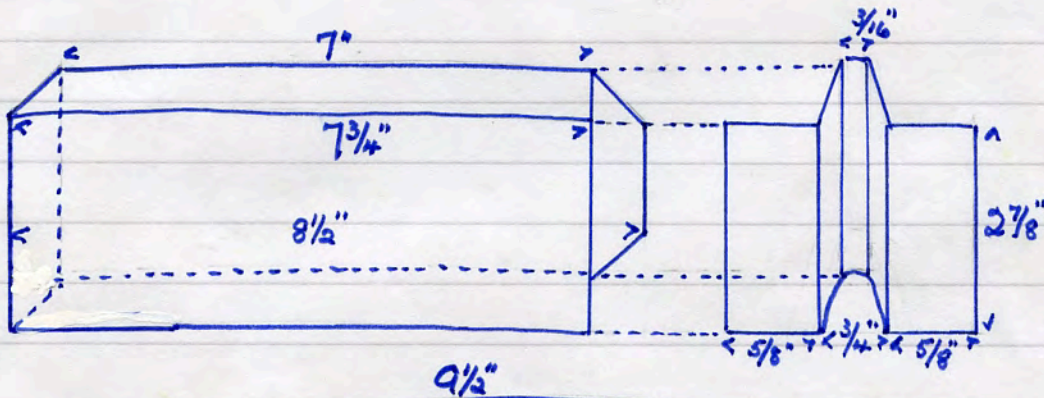

5050

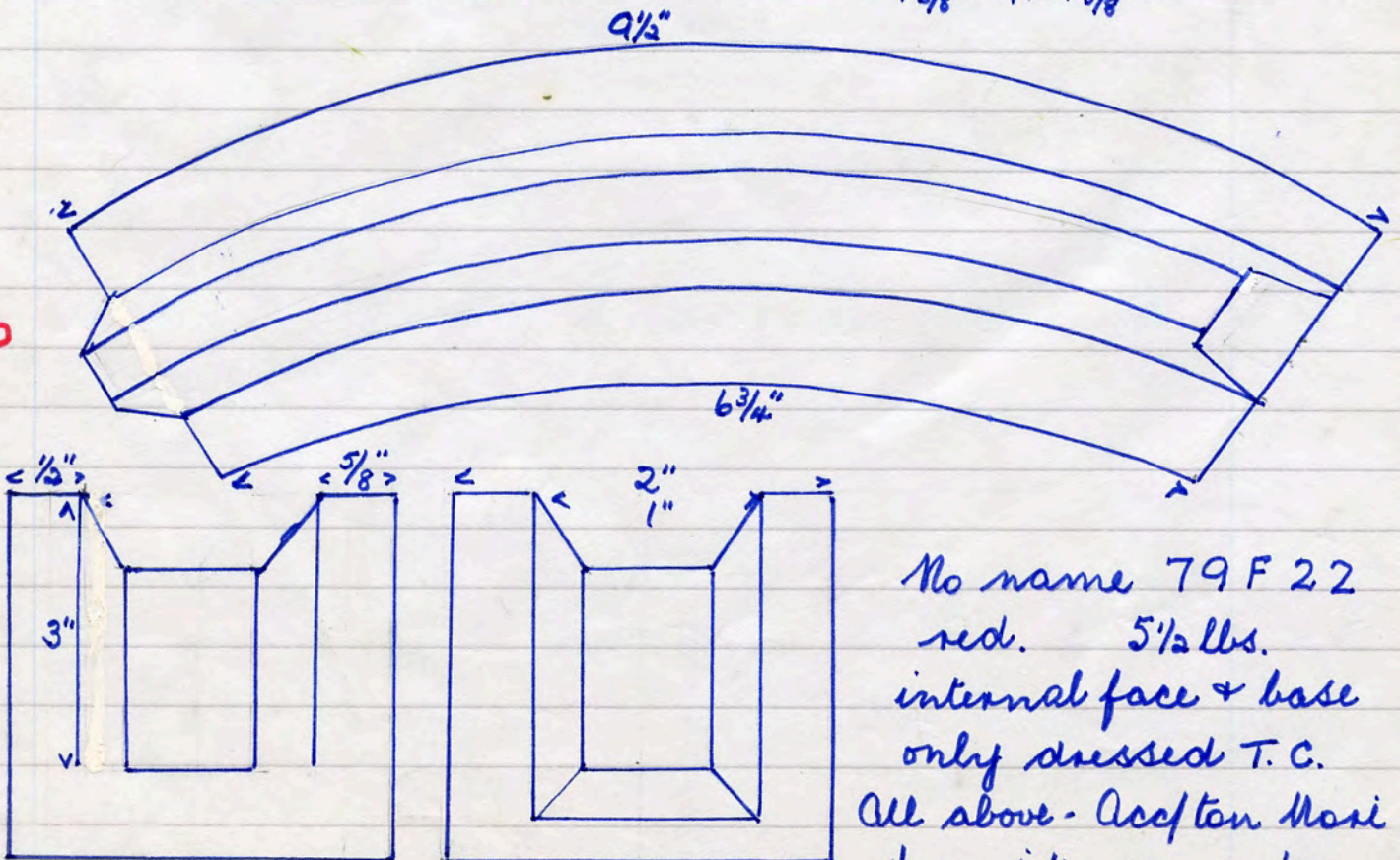

No name 79 F 22
 red. 5 1/2 lbs.
 internal face & base
 only dressed T.C.
 All above - Accpton Moss
 dem. site 20. 8. '90

No name 70 N 31 red. face side + face edge AB dressed

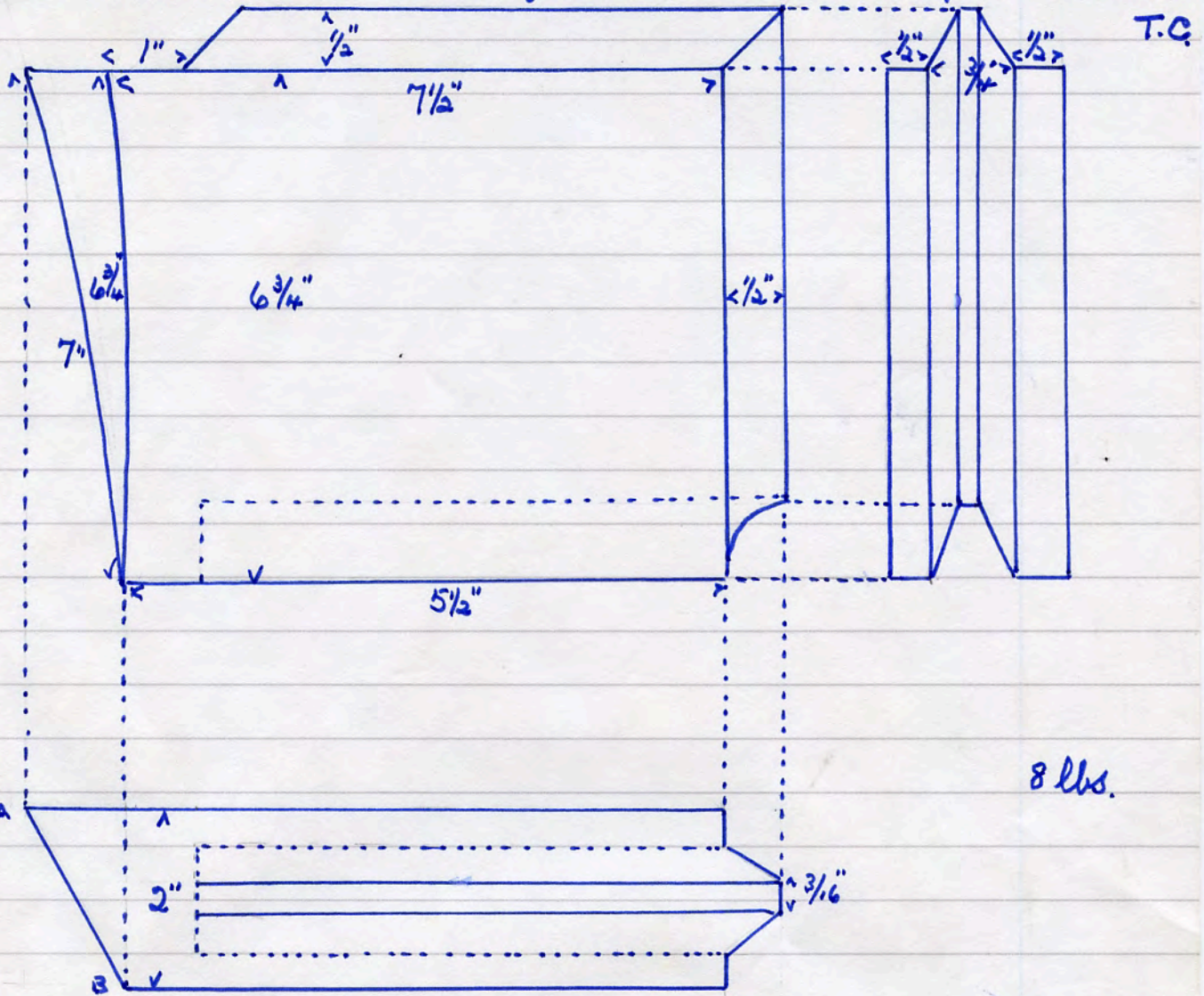

No name LY. red. dressed T.C. on face side m's m J1

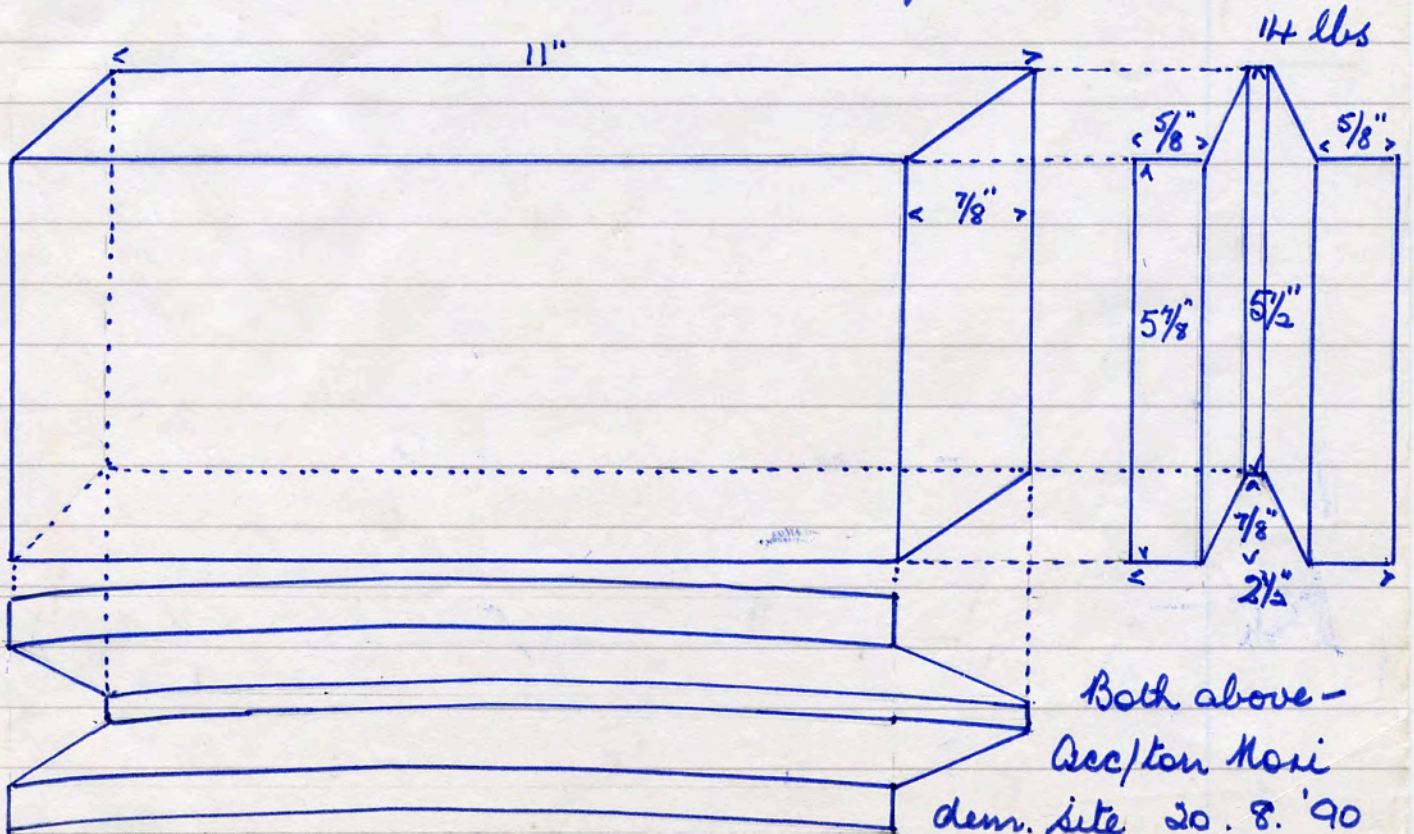

5053

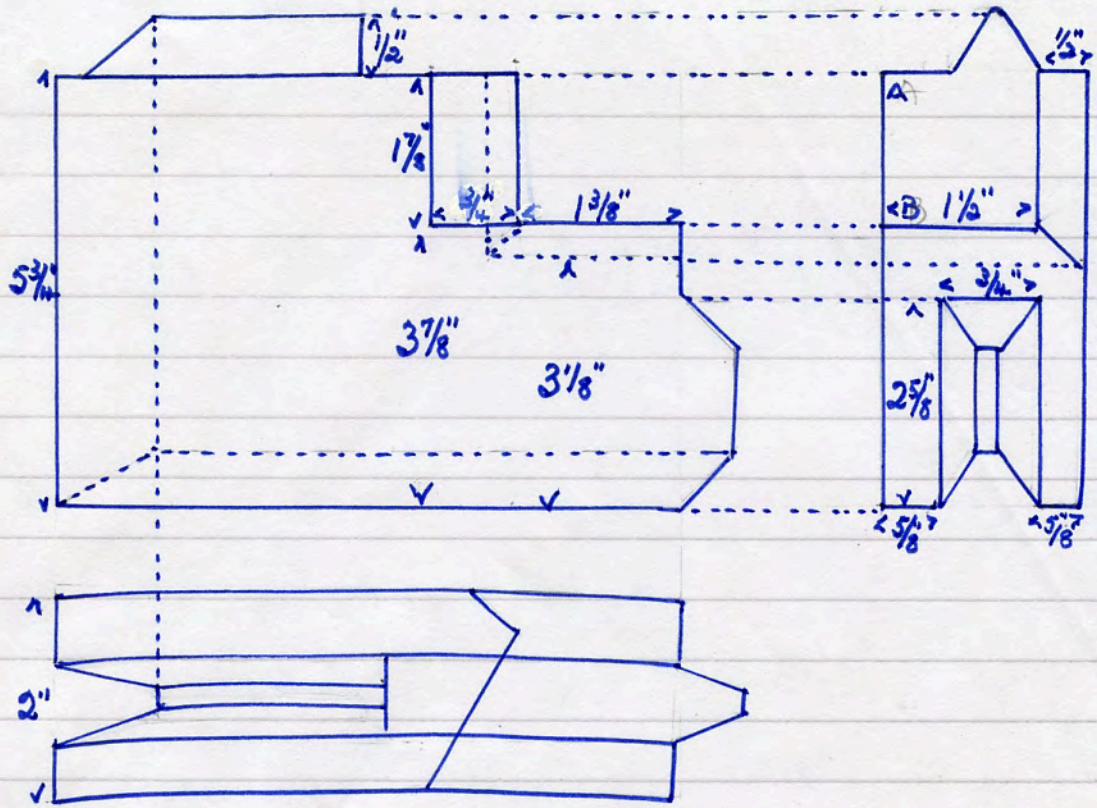

No name 98 H 11 red. inside + edges AB dressed T.C. 8 lbs

5054

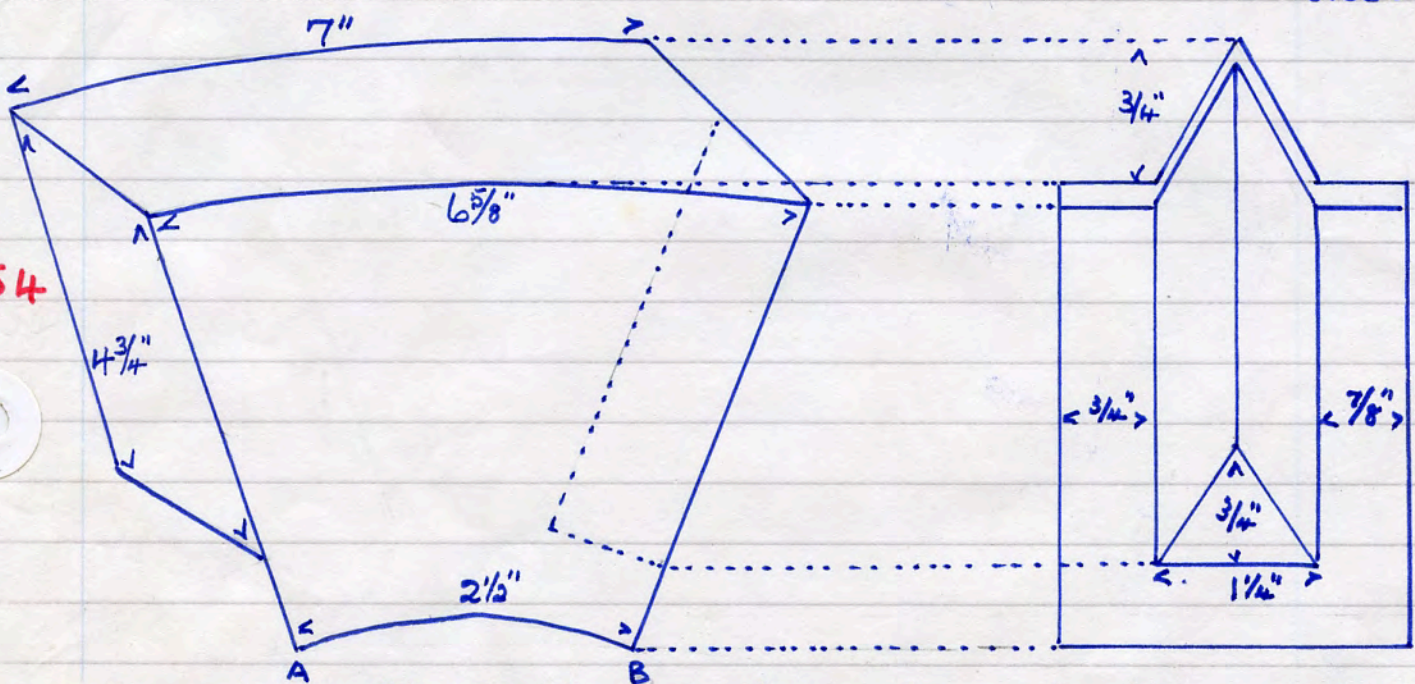

No name 91 N 1 A x red. face side + inside AB dressed T.C. 8 lbs

Both above - Accpton Mori dem. site 20. 8. '90

50565

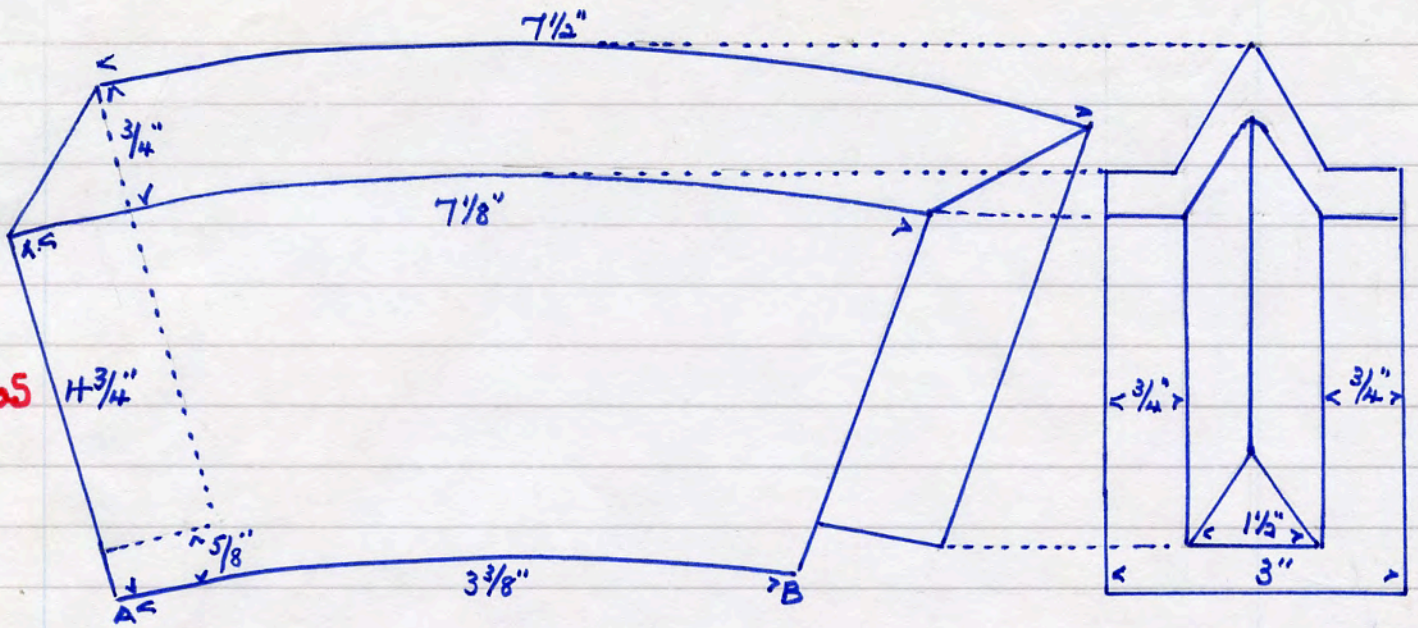

No name 91N1 red. internal surface AB + face side T.C. dressed.
 7 lbs. m's mark .J1

5056

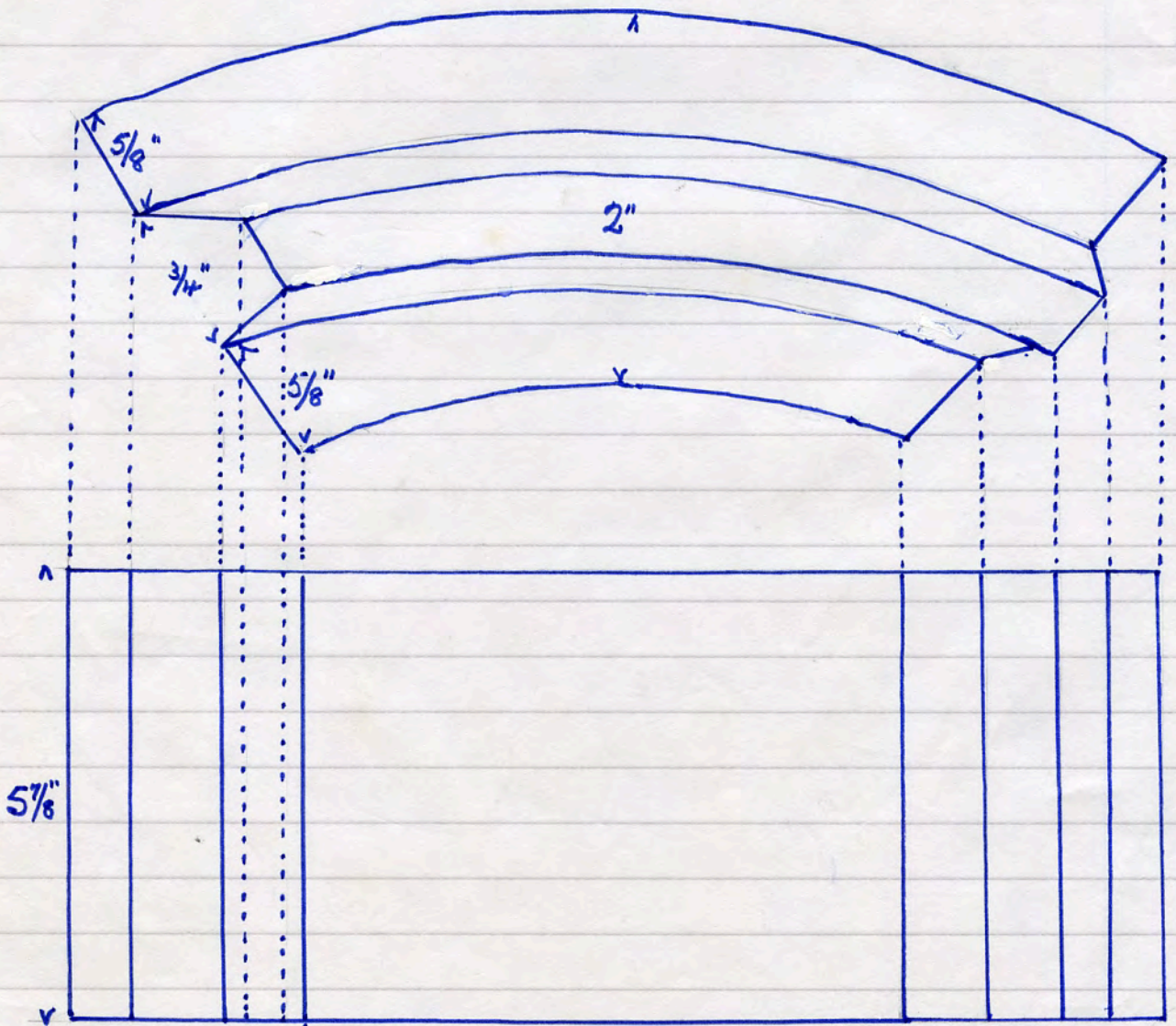

No name 79F21 red. inner surface dressed T.C. 8 lbs.
 Both above - Acceptor Hosi dem. site 21. 8. '90

No name 75G 9 red. internal surface dressed T.C.

21 lbs

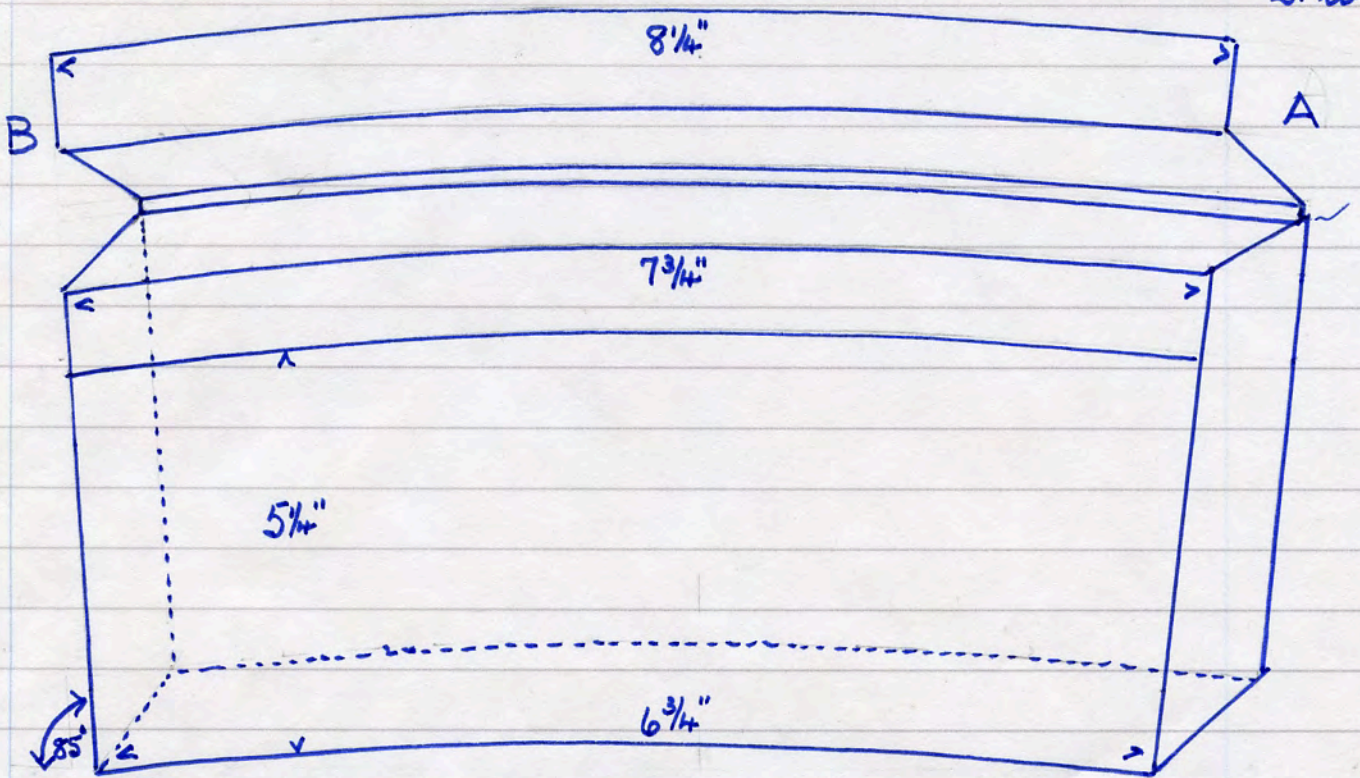

5057

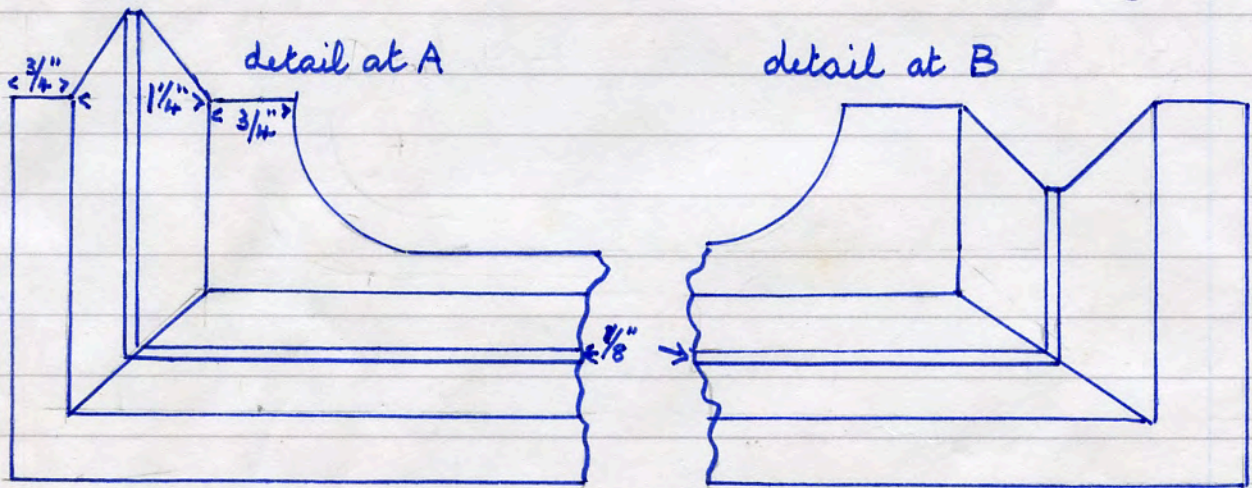

5058

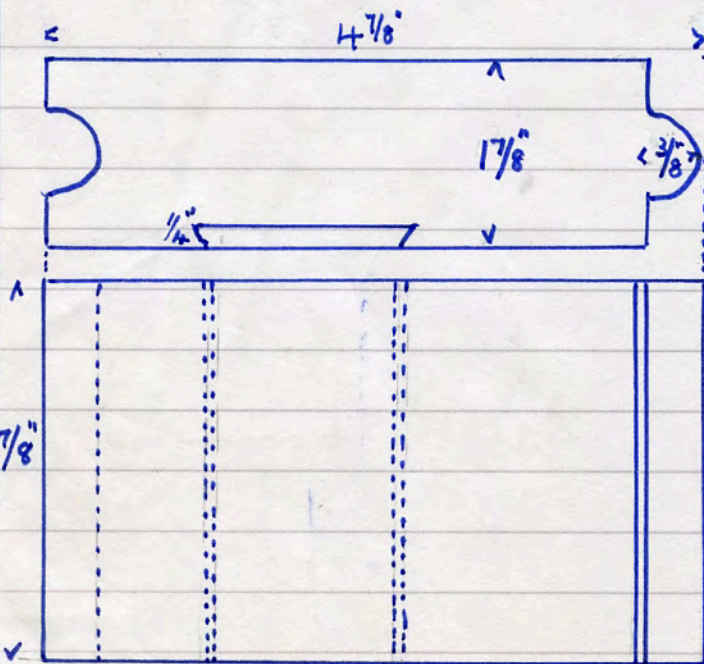

No name 94ND red. T.C. dressed all round 5 lbs.

Both above -
Acception Mori dem. site
21. 8. '90

No name NBI red. 1 face side only T.C. 23 lbs.

5059

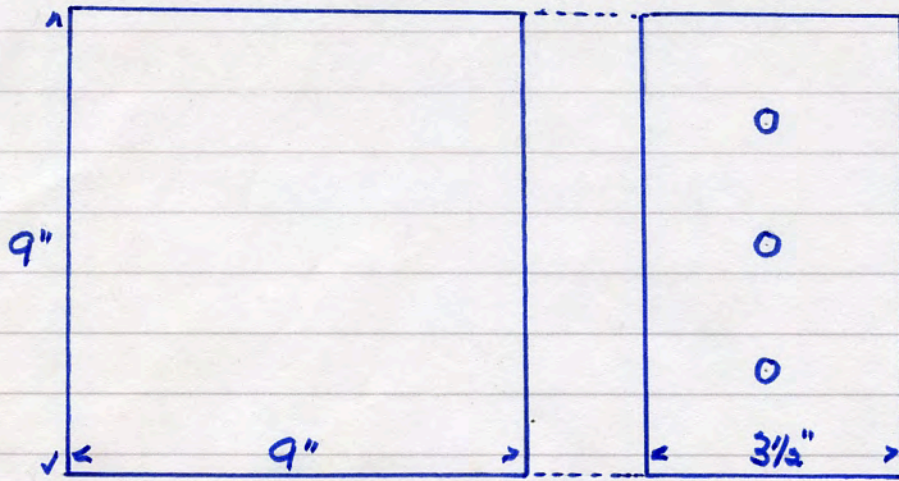

No name 50 G 36 red. internal face & ends T.C. 4 1/2 lbs

5060

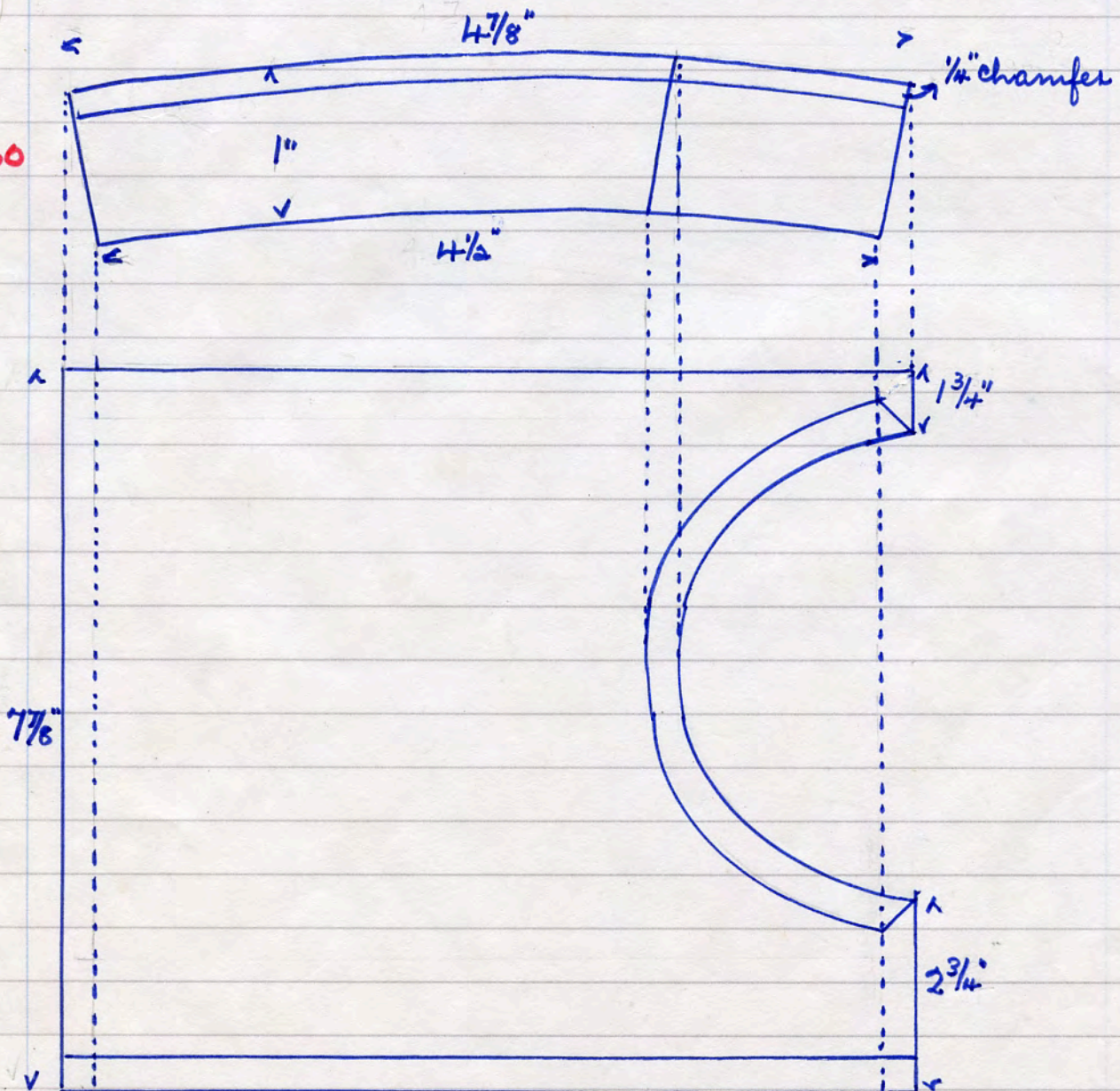

Both above. Acceptor Masi dem. site 21. 8. 90

No name 50 G 28 red
2 1/2 lbs

left hand.

5061

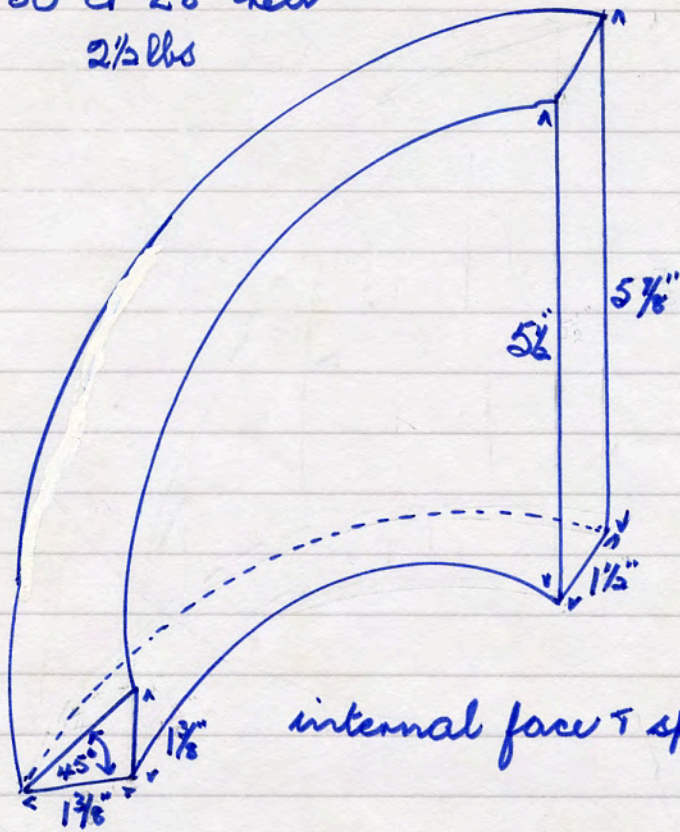

internal face & splayed surface
dressed T.C.

No name 50 G 27 red. specifications same as above
2 1/2 lbs right hand

5062

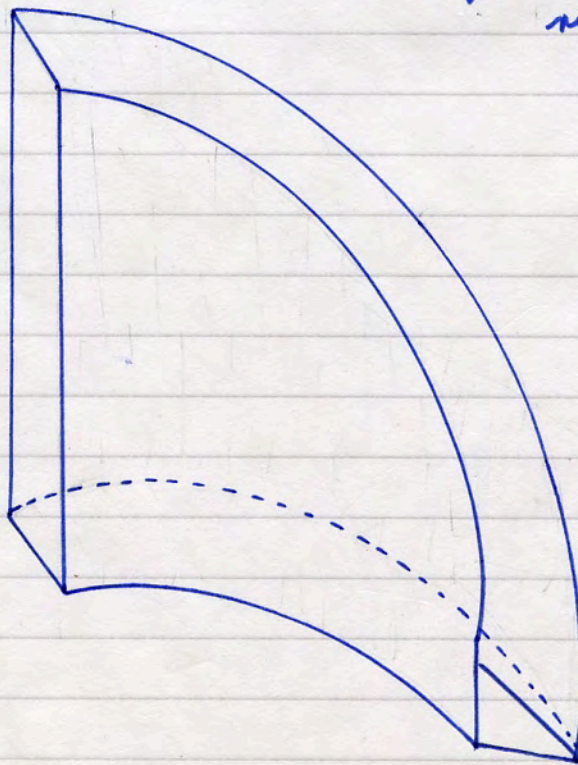

Both above - Acc/ton Mori dem. site 22. 8. '90

ACCRINGTON NORI 313 3 B red gauged
9 lbs. $8\frac{1}{2}'' - 8\frac{1}{8}'' \times 4'' \times 2\frac{7}{8}''$ wire cut.

21. 9cms - 20.5cms x 10cms x 7.4cms.

5065 no panels. letters stamped on long edge.
Accrington Maxi dem. 31. 3. '91

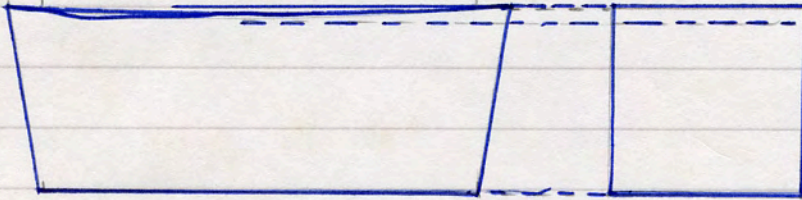

5077

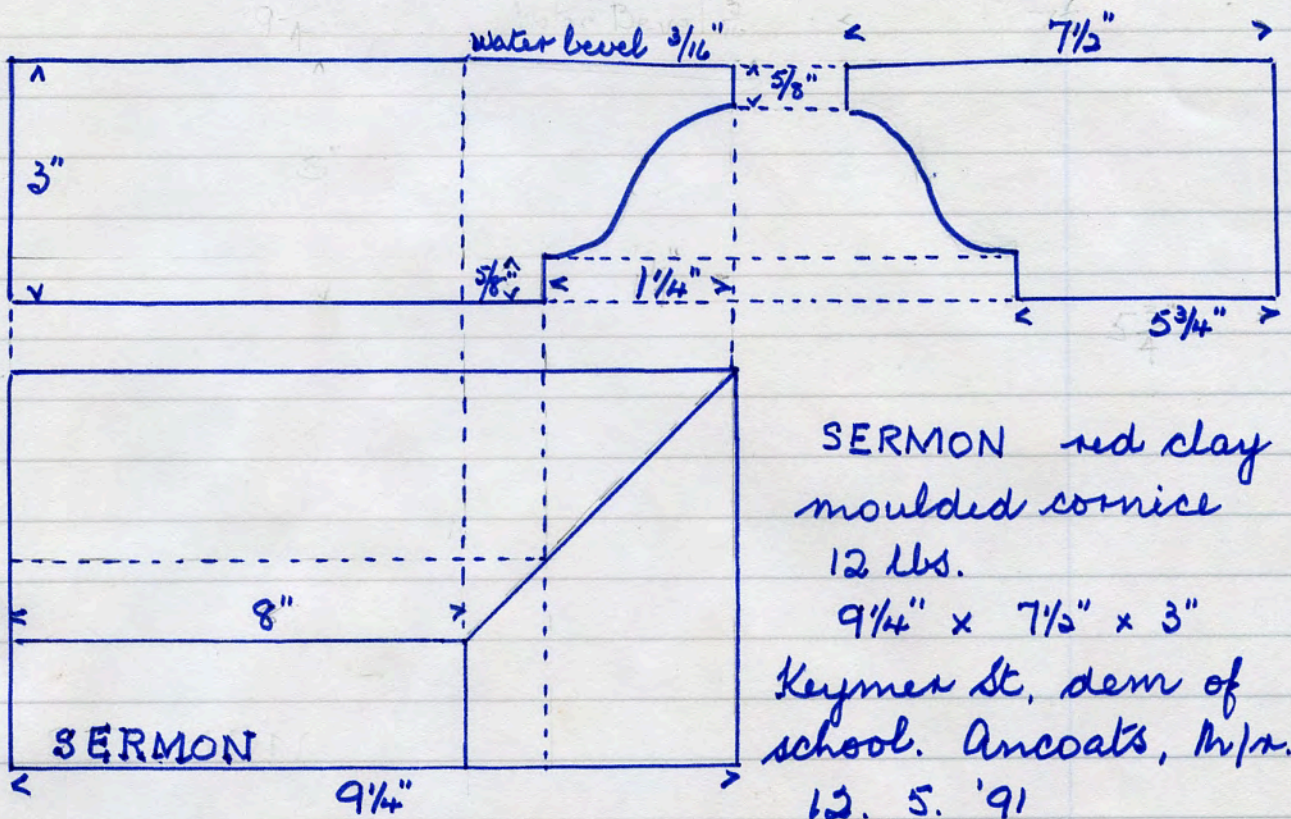

SERMON red clay
moulded cornice
12 lbs.
 $9\frac{1}{4}" \times 7\frac{1}{2}" \times 3"$
Keymer St, dem of
school. Ancoats, M/n.
12. 5. '91

5078

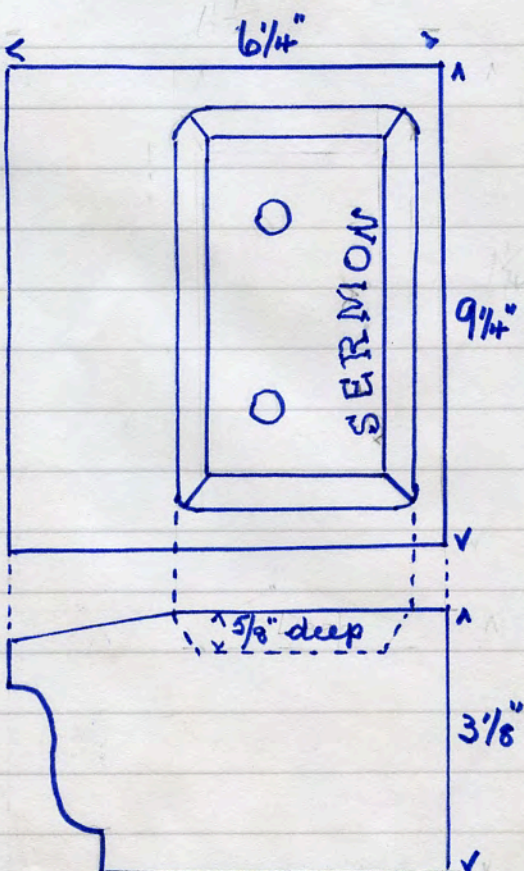

SERMON red clay moulded
cornice
11 lbs. $9\frac{1}{4}" \times 6\frac{1}{4}" \times 3\frac{1}{8}"$
school dem.
Keymer St, Ancoats, M/n.
12. 5. '91

5079

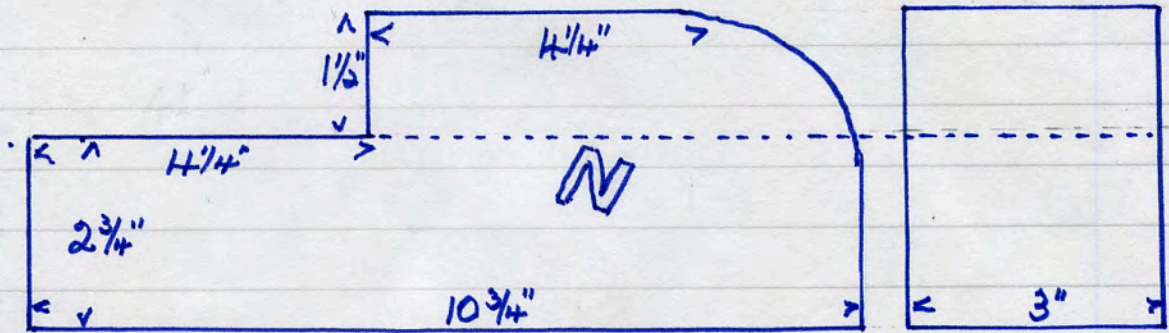

no name (Huncoat bricks on same site)
 red rebated jamb brick. 11 lbs
 N stamped on 1 side.

5080

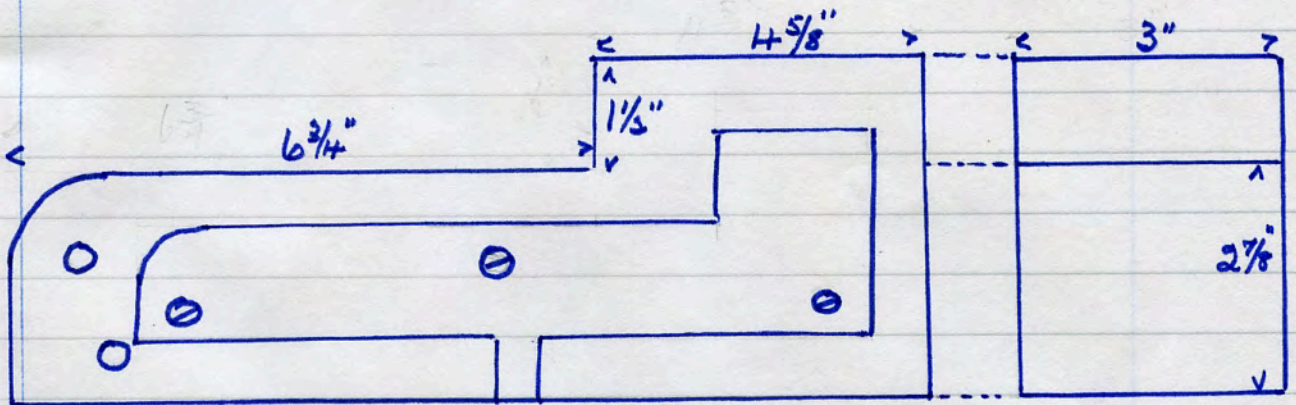

no name. red rebated and nosed.
 single panel each side. 11 lbs.

5081

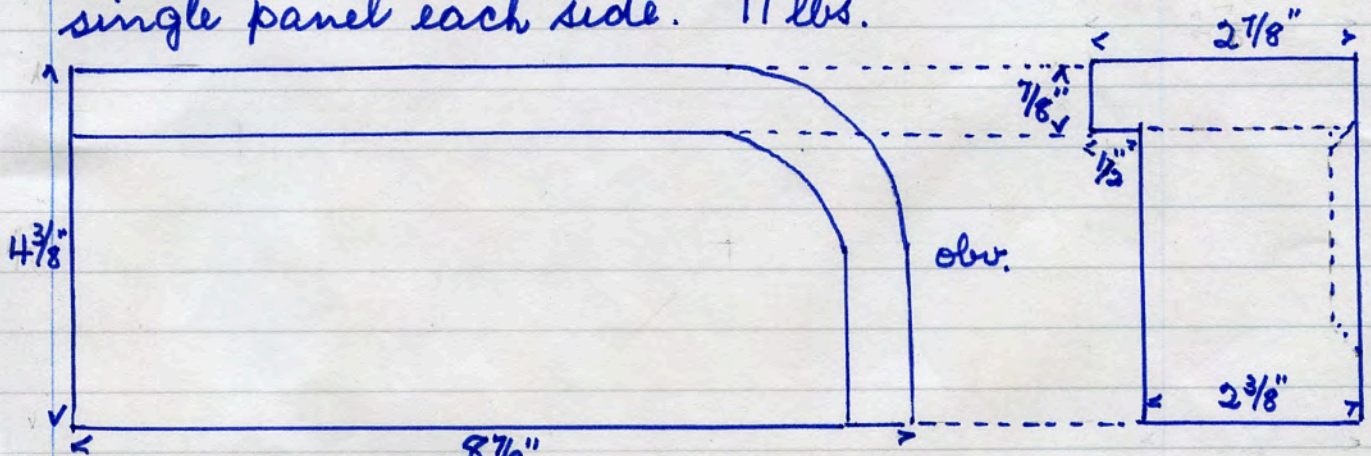

no name S stamped on rev. red T.C.
 (Huncoat bricks on same site)

Middleton Rd
 Community
 Centre dem.

19. 5. '91

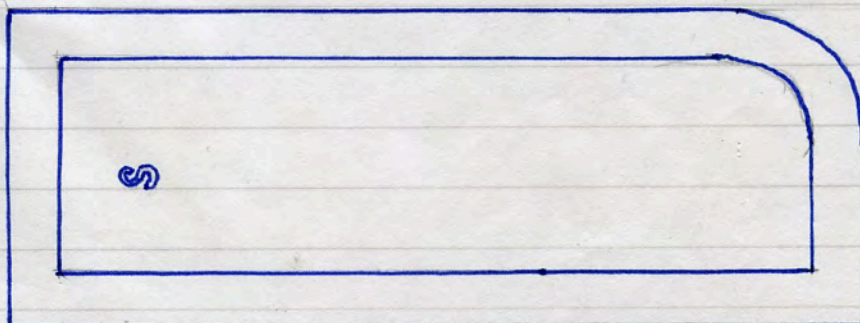

rev.

no name. red marl string course headers. 9 lbs

5082

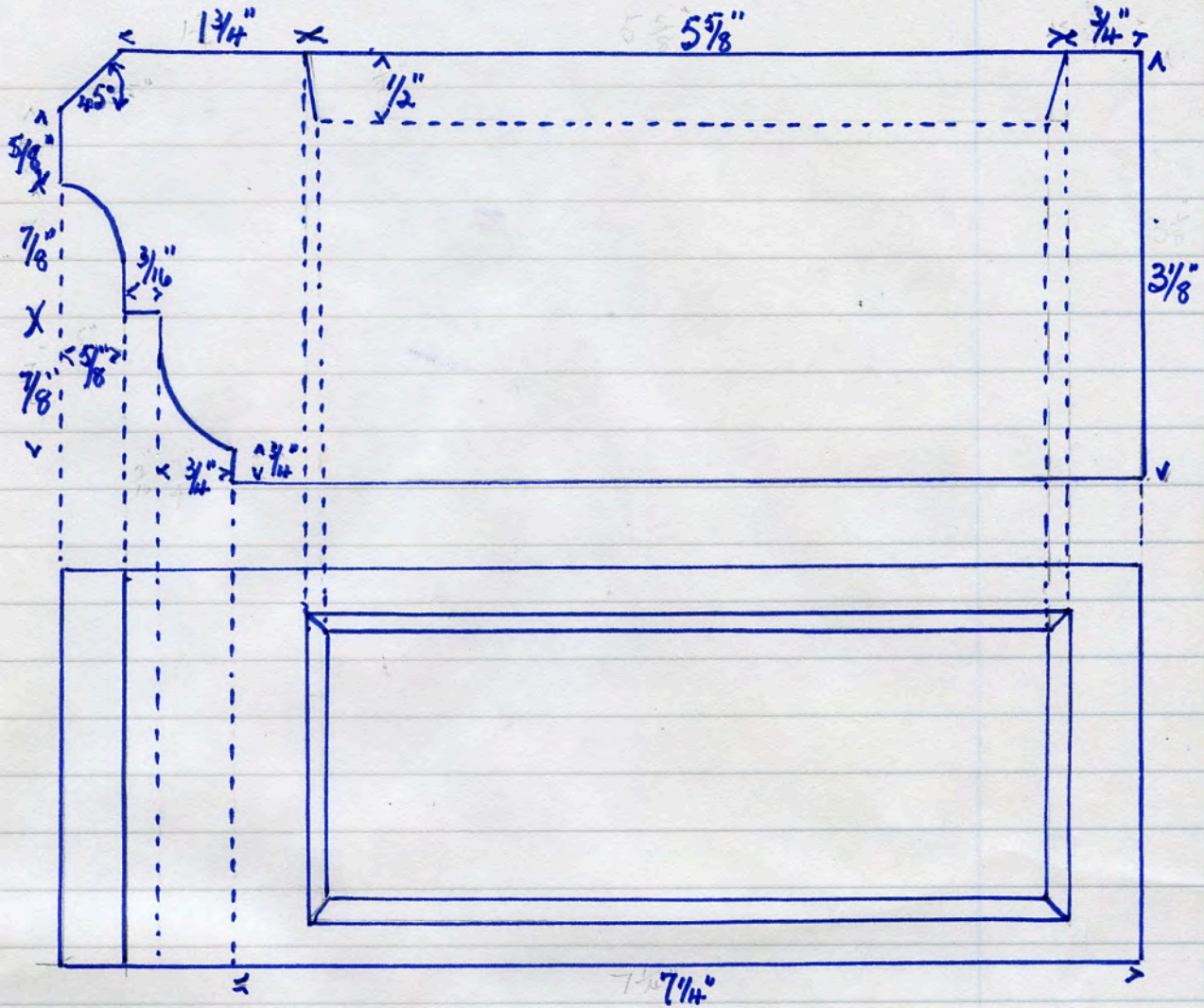

Parrott St. Blayton, M.P. pub or club alteration. 9 lbs.

5083

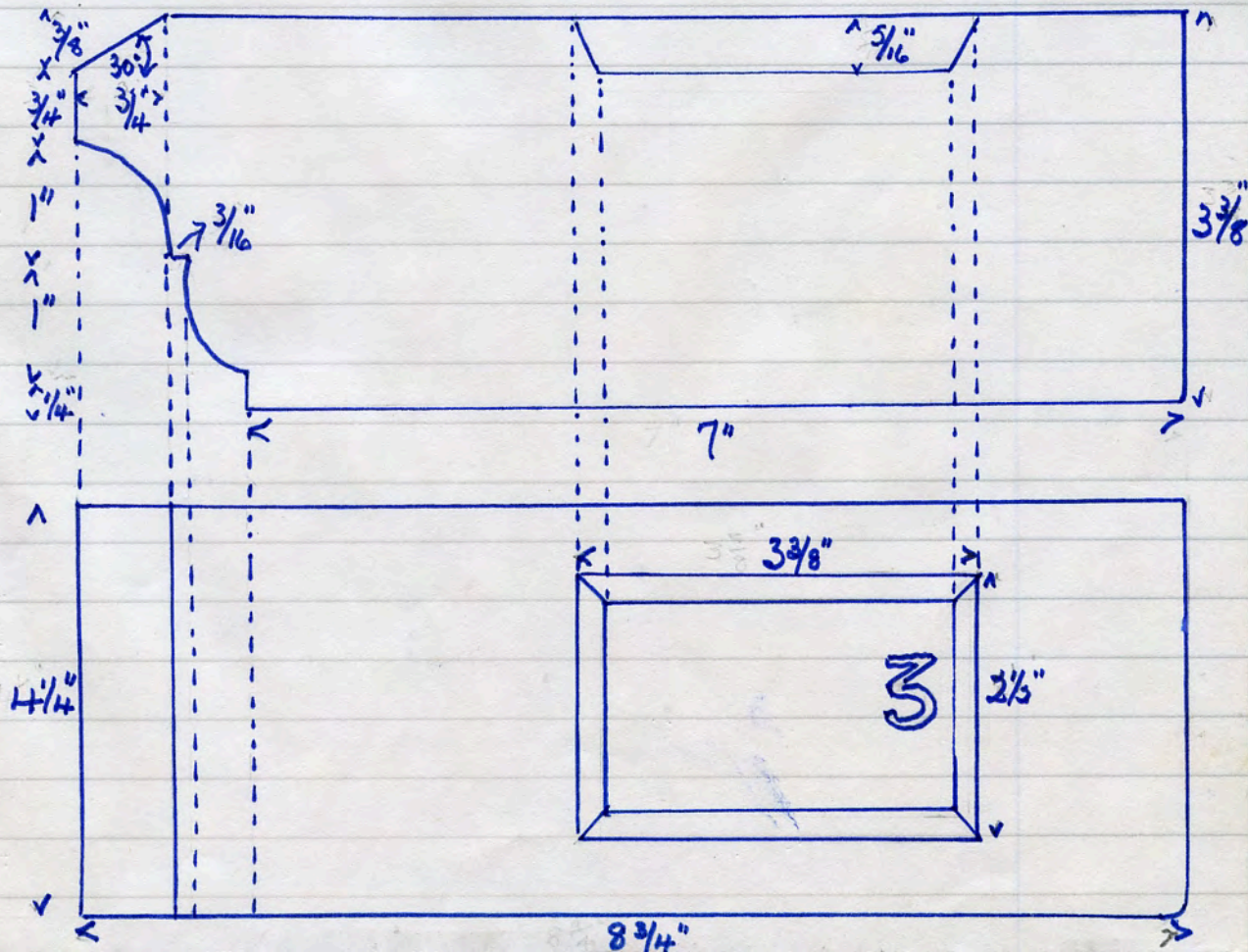

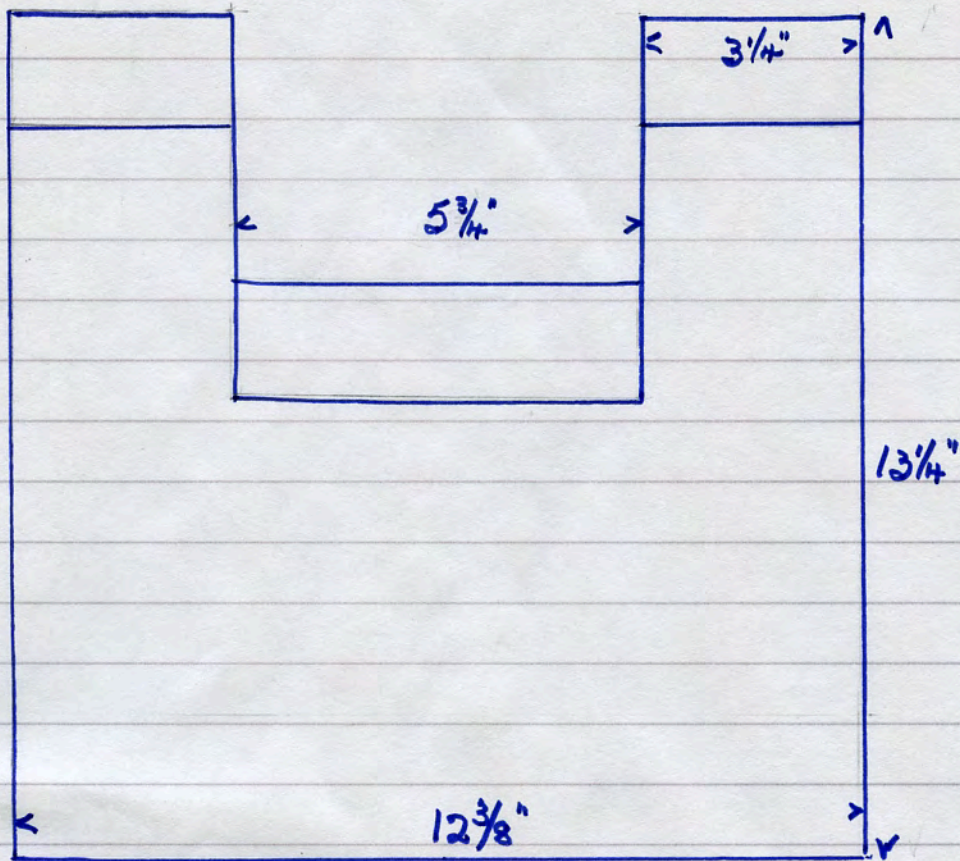

5084

No name
red ridge tile
17 lbs

Pottery Lane,
dem. at Keymer St,
Ancoats, M/r.
12. 5. '91

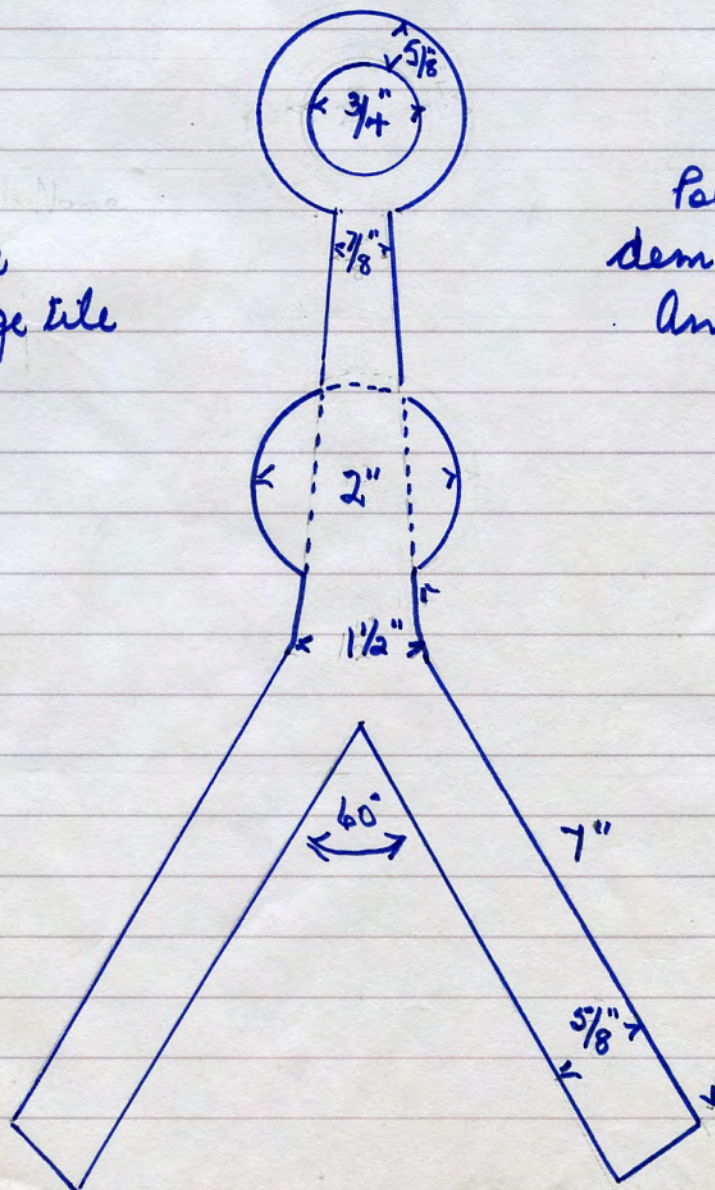

DENNIS RUABON

red T.C. ridge tile

14 lbs.
name stamped
inside

Waterfoot Post Office
18. 7. '91

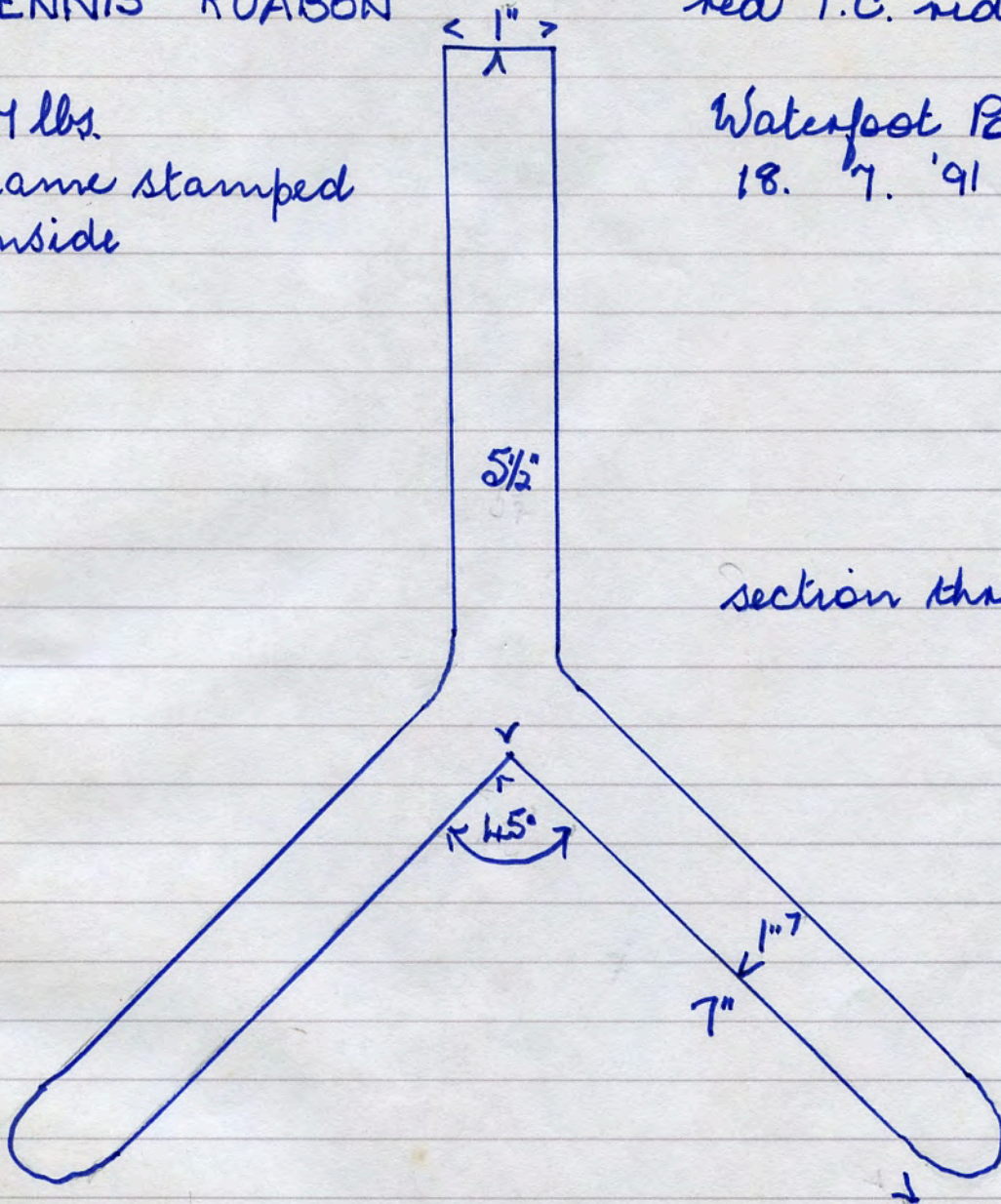

section through tile

5089

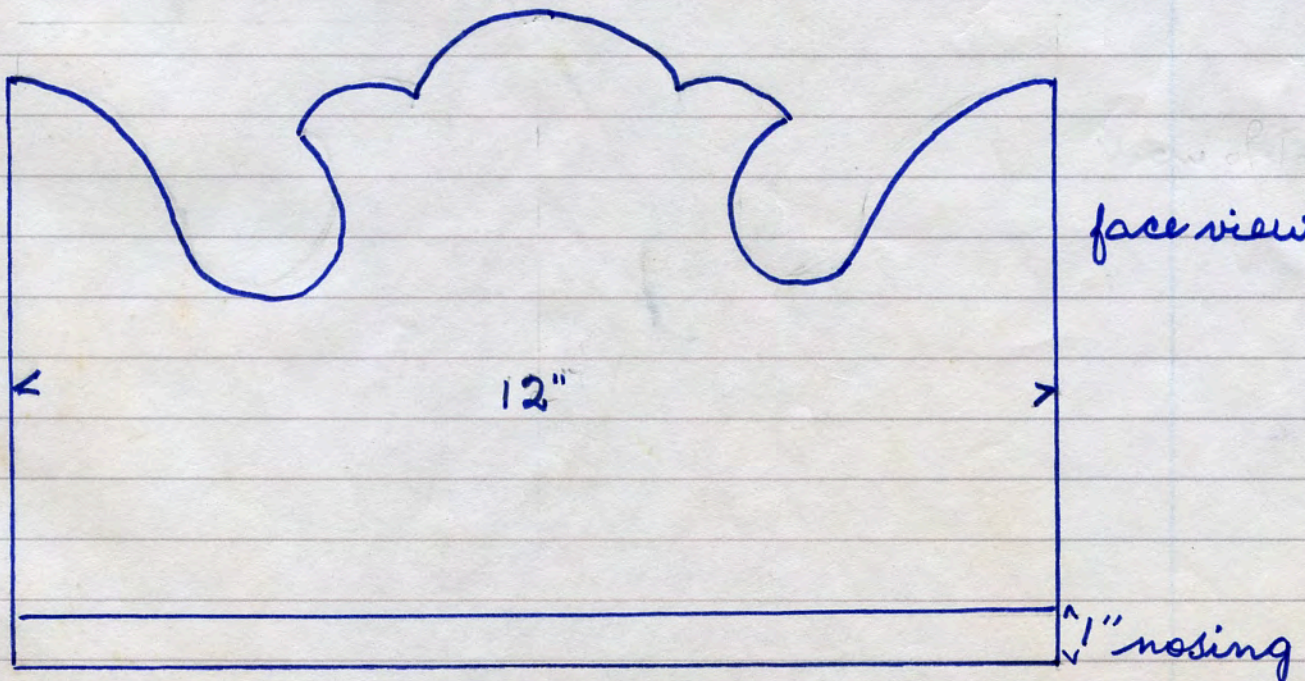

face view.

12"

1" nosing